

GENERAL DESCRIPTION

The ME25N06 is the N-Channel logic enhancement mode power field effect transistors are produced using high cell density, DMOS trench technology. This high density process is especially tailored to minimize on-state resistance. These devices are particularly suited for low voltage application such as cellular phone and notebook computer power management and other battery powered circuits where high-side switching, and low in-line power loss are needed in a very small outline surface mount package.

FEATURES

- $R_{DS(ON)} \leq 62m\Omega @ V_{GS}=10V$
- $R_{DS(ON)} \leq 86m\Omega @ V_{GS}=4.5V$
- Super high density cell design for extremely low $R_{DS(ON)}$
- Exceptional on-resistance and maximum DC current capability

APPLICATIONS

- Power Management in Note book
- DC/DC Converter
- Load Switch
- LCD Display inverter

PIN CONFIGURATION

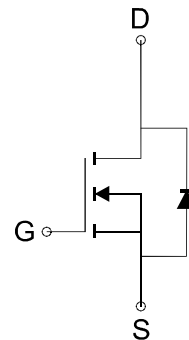
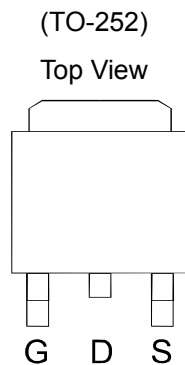

N-Channel MOSFET

Ordering Information: ME25N06 (Pb-free)

ME25N06-G (Green product)

Absolute Maximum Ratings (TA=25°C Unless Otherwise Noted)

Parameter		Symbol	Rating	Unit	
Drain-Source Voltage		V_{DSS}	60	V	
Gate-Source Voltage		V_{GSS}	± 25	V	
Continuous Drain Current (Tj=150°C)	Tc=25°C	I_D	16	A	
	Tc=70°C		13		
Pulsed Drain Current		I_{DM}	65	A	
Maximum Power Dissipation	Tc=25°C	P_D	25	W	
	Tc=70°C		16		
Operating Junction Temperature		T_J	-55 to 150	°C	
Thermal Resistance-Junction to Case *		$R_{\theta JC}$	Steady State	5	°C/W

* The device mounted on 1in² FR4 board with 2 oz copper

Symbol	Parameter	Limit	Min	Typ	Max	Unit
STATIC						
BV _{DSS}	Drain-Source Breakdown Voltage	V _{GS} =0V, I _D =250 μA	60			V
V _{GS(th)}	Gate Threshold Voltage	V _{DS} =V _{GS} , I _D =250 μA	1		3	V
I _{GSS}	Gate Leakage Current	V _{DS} =0V, V _{GS} =±25V			±100	nA
I _{DSS}	Zero Gate Voltage Drain Current	V _{DS} =60V, V _{GS} =0V			1	μA
		V _{DS} =60V, V _{GS} =0V, T _J =55°C			10	
R _{DS(ON)}	Drain-Source On-Resistance ^a	V _{GS} =10V, I _D =15A		52	62	mΩ
		V _{GS} =4.5V, I _D =10A		70	86	
V _{SD}	Diode Forward Voltage	I _S =15A, V _{GS} =0V		1		V
DYNAMIC						
Q _g	Total Gate Charge	V _{DS} =48V, V _{GS} =10V, I _D =16A		17		nC
Q _{gs}	Gate-Source Charge			4.2		
Q _{gd}	Gate-Drain Charge			5		
R _g	Gate Resistance	V _{DS} =0V, V _{GS} =0V, f=1MHz		0.6		Ω
C _{iss}	Input Capacitance	V _{DS} =30V, V _{GS} =0V, f=1MHz		523		pF
C _{oss}	Output Capacitance			47		
C _{rss}	Reverse Transfer Capacitance			14		
t _{d(on)}	Turn-On Delay Time	V _{DD} =30V, R _L =15Ω I _D =1A, V _{GEN} =10V R _G =3Ω		11		ns
t _r	Turn-On Rise Time			13		
t _{d(off)}	Turn-Off Delay Time			34		
t _f	Turn-Off Fall Time			4		

Notes: a, pulse test: pulse width ≤ 300us, duty cycle ≤ 2%, Guaranteed by design, not subject to production testing.

Matsuki reserves the right to improve product design, functions and reliability without notice.

Typical Characteristics (T_J = 25°C Noted)

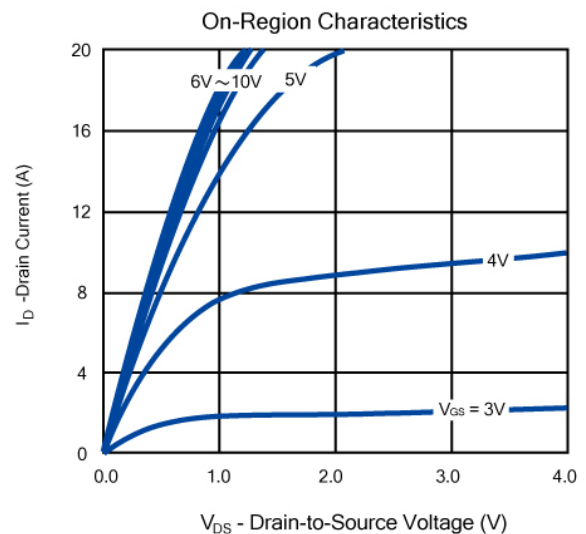
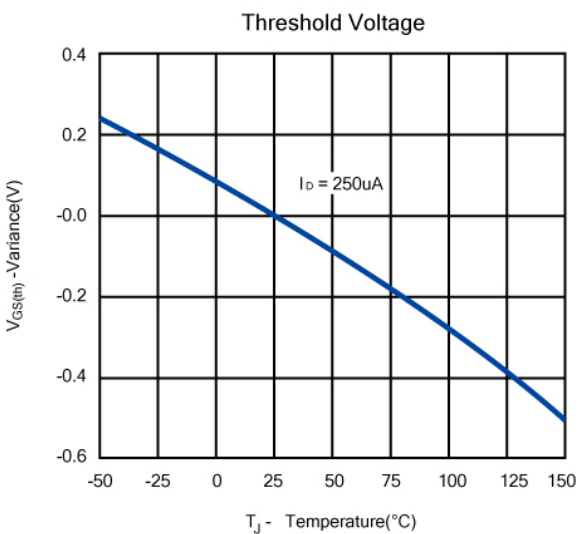
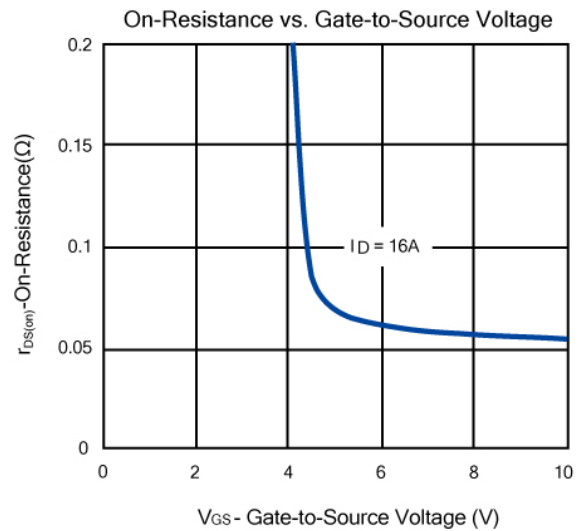
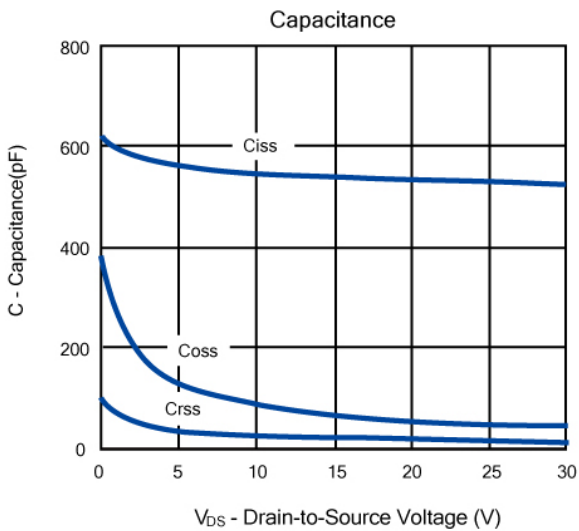
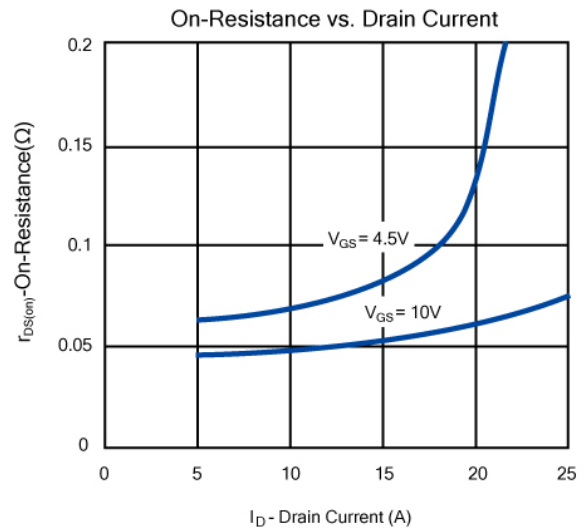
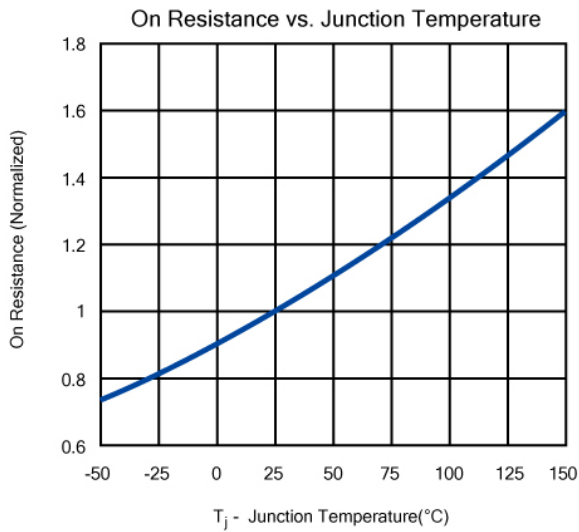

Typical Characteristics (T_J = 25°C Noted)

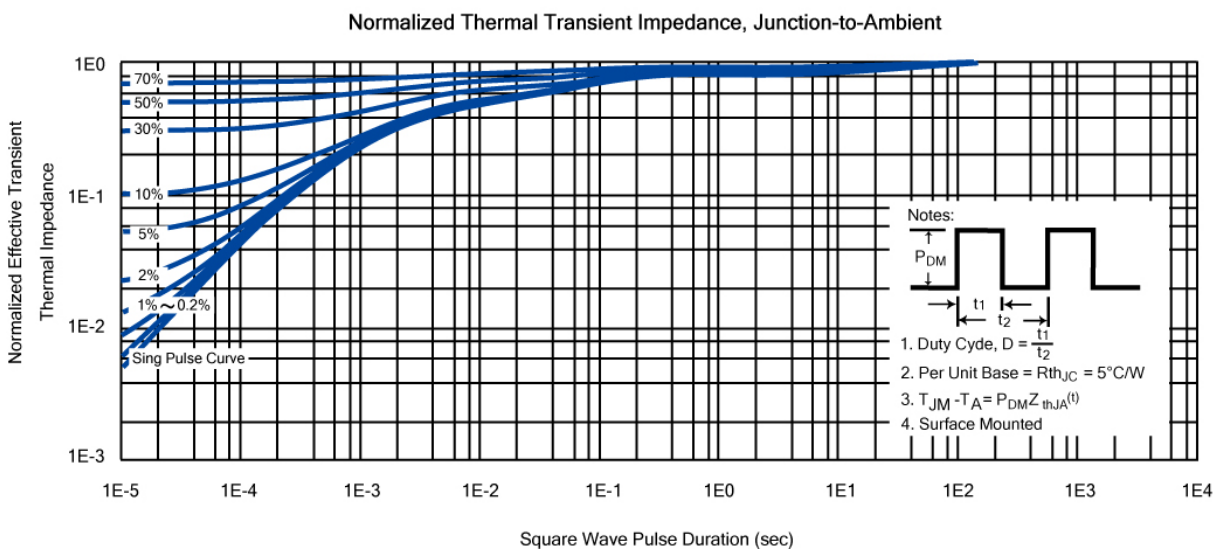
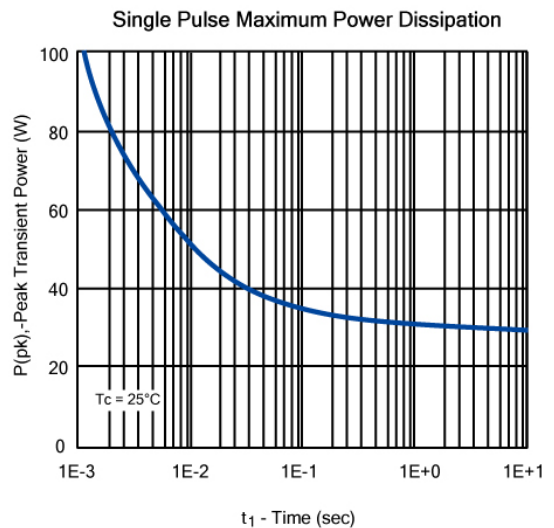
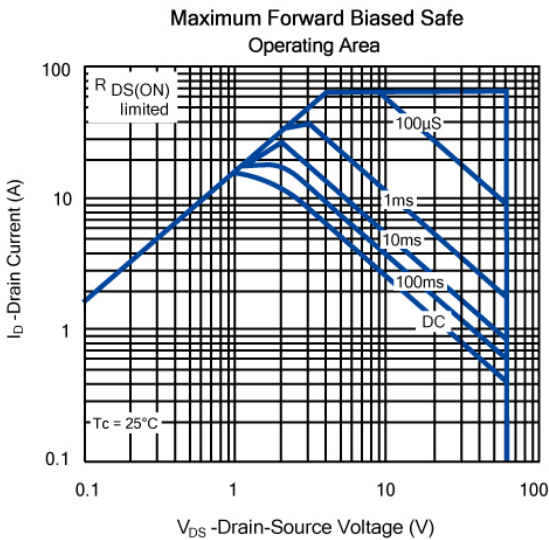
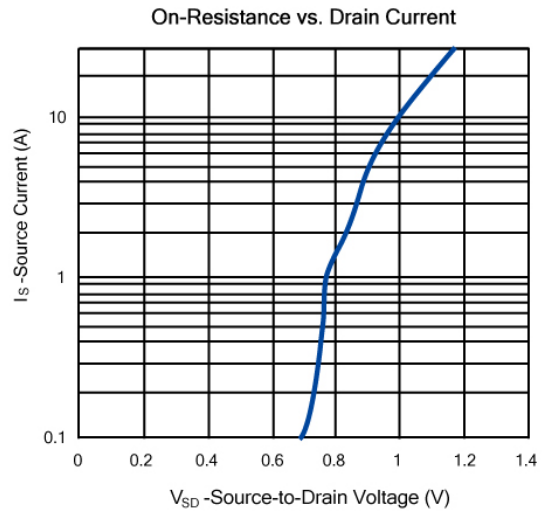
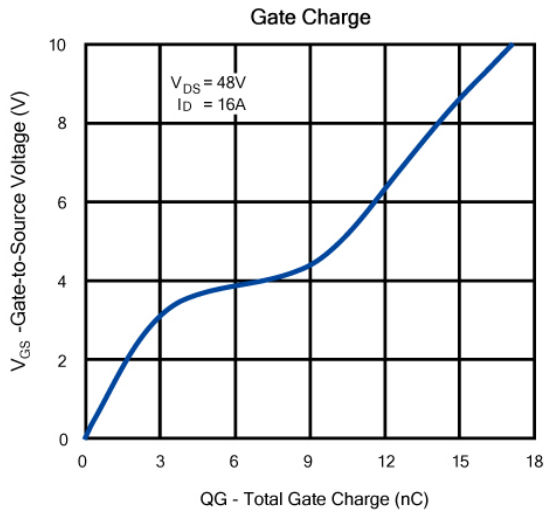

TO-252 Package Outline

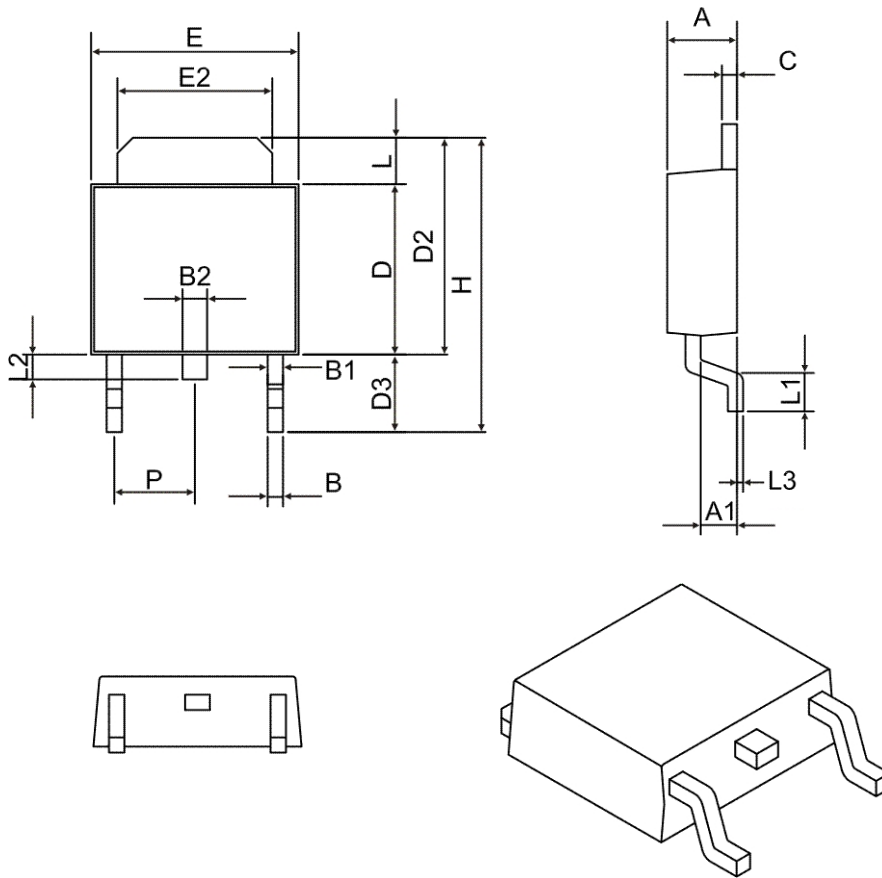

SYMBOL	MILLIMETERS (mm)	
	MIN	MAX
A	2.00	2.50
A1	0.90	1.30
B	0.50	0.85
B1	0.50	0.80
B2	0.50	1.00
C	0.40	0.60
D	5.20	5.70
D2	6.50	7.30
D3	2.20	3.00
H	9.50	10.50
E	6.30	6.80
E2	4.50	5.50
L	1.30	1.70
L1	0.90	1.70
L2	0.50	1.10
L3	0	0.30
P	2.00	2.80