

5V, 3A COT Synchronous Step-Down DC/DC Converter

Description

ME3109 is a high efficiency, easy-to-use, COT synchronous step-down DC/DC converter with an input voltage range of 2.8V to 5.5V. And its output voltage is fixed inside while delivering up to 3A of output current.

The Voltage Mode Constant On-Time (COT) operation with internal compensation allows the transient response to be optimized over a wide range of loads and output capacitors. Different chips have different working modes. The main differences are: PWM / PFM automatic switching mode series; independent selection of working mode. In the automatic switching mode, the continuous mode works at a constant frequency of 1.2MHz, and it works in the discontinuous mode at light load, thereby achieving high efficiency characteristics in the full load range.

ME3109 integrated a few protect circuits to make the system works in safety stations. It contains input Under-Voltage Lockout, over-current protection and short-circuit protection and over temperature protection.

Applications

- Bluetooth, Cable Modem
- LCD TV Power Supply & Metering Platforms
- General Purpose Point-of-Load (POL)
- Mobile devices

Feature

- Output current: 3A(TYP)
- Efficiency: 96% (@ $I_{OUT}=500mA$, $V_{OUT}=3.3V$)
- Input Voltage: 2.8~5.5V
- Output Voltage: 0.8V~3.6V ($\pm 2.0\%$)(ME3109A)
- Feedback Voltage: 0.6V ($\pm 2.0\%$) (ME3109F)
- Voltage Mode Constant On-Time Control
- Input Under-Voltage Lockout
- Internally Soft-Start Function
- Over-current protection and short-circuit protection
- Over Temperature protection
- Only need two ceramic Capacitors and an inductor(ME3109A)

Package

- 6-pin DFN2*2-6L

Typical Application Circuit

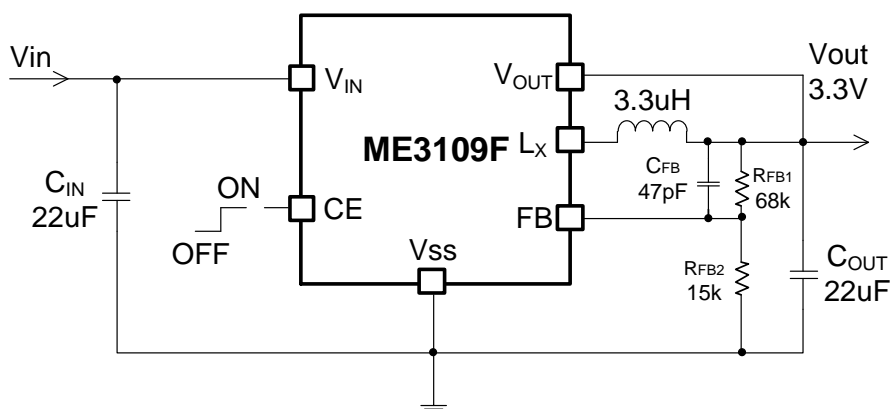
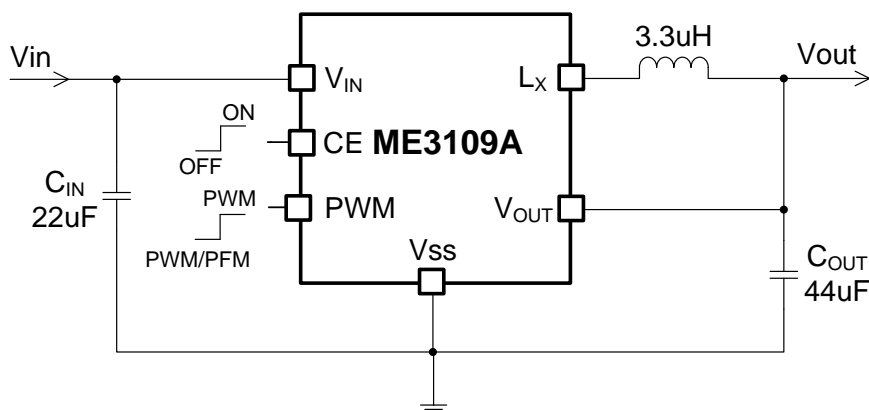

Selection Guide

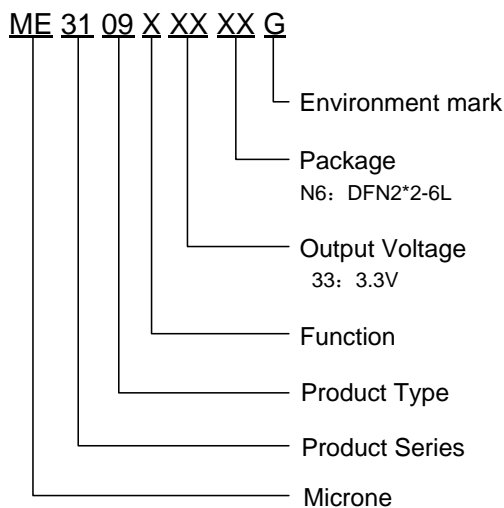

product series	product description
ME3109A33N6AG	built-in MOSFET, independent selection mode , $V_{OUT}=3.3V$; package: DFN2*2-6L
ME3109FAN6AG	built-in MOSFET, With feedback function; PWM / PFM automatic switching mode; package: DFN2*2-6L

NOTE: If you need other voltage and package, please contact our sales staff.

Pin Configuration (Top View)

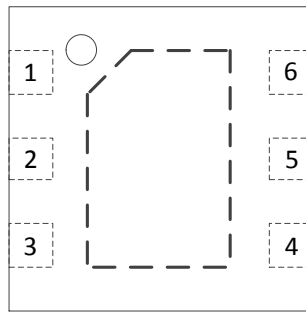

DFN2*2-6

Pin Assignment

PIN Number ME3109A	PIN Number ME3109F	symbol	Function
1	1	Lx	Switch
2	-	PWM	Work mode switching
-	2	FB	Feedback
3	3	V _{OUT}	Output
4	4	CE	Enable
5	5	V _{IN}	Input
6	6	V _{SS}	Ground

Block Diagram

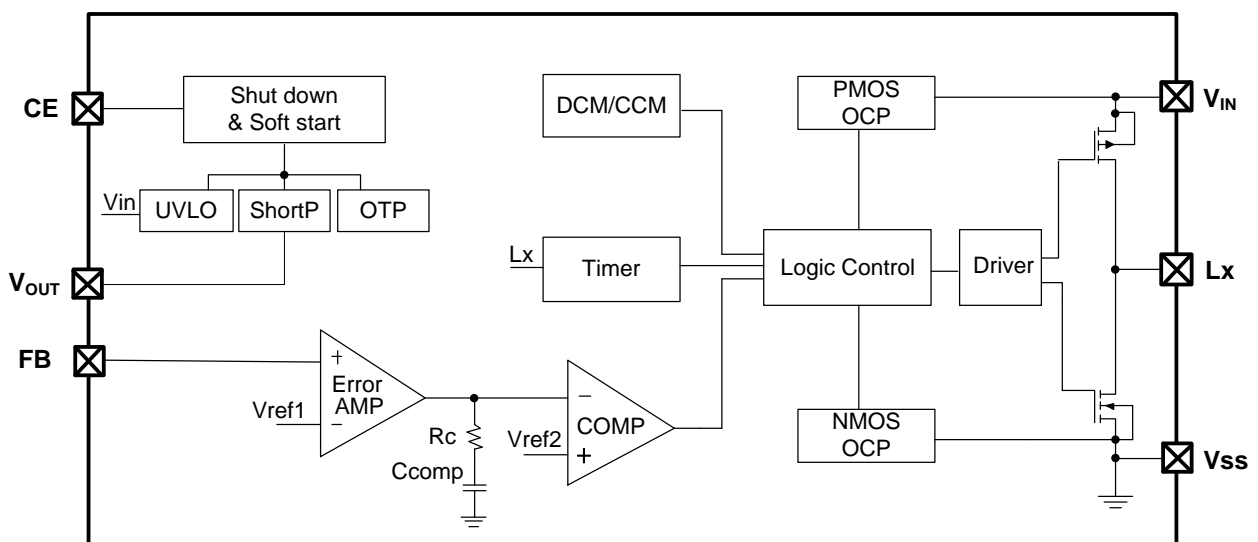

Absolute Maximum Ratings

Parameter	Symbol	Ratings	Units	
Input Voltage	V_{IN}	-0.3~6.0	V	
Lx Pin Voltage	V_{Lx}	-0.3~6.2	V	
CE Pin Voltage	V_{CE}	-0.3~6.0	V	
V_{OUT} Pin Voltage	V_{OUT}	-0.3~4.0	V	
FB Pin Voltage	V_{FB}	-0.3~6.0	V	
Internal Power Dissipation	DFN2*2-6	P_d	1.3	W
Thermal resistance (Junction to air)	DFN2*2-6	θ_{JA}	95	°C/W
Operating Ambient Temperature Range	T_{Opr}	-40~+105	°C	
Storage Temperature Range	T_{stg}	-55~+150	°C	
Maximum junction temperature	T_J	-40~+150	°C	

Electrical Characteristic

ME3109A test conditions: $V_{IN}=5V$, $V_{PWM}=0V$, $V_{CE}=5V$, $T_{opt}=25^\circ C$ unless otherwise noted.

Parameter	Symbol	Condition	Min	Typ	Max	Unit	Circuit
Input Voltage Range	V_{IN}		2.8	-	5.5	V	1
Output Voltage	V_{OUT}		V_{OUT} *0.98	V_{OUT}	V_{OUT} *1.02	V	1
UVLO Voltage	V_{UVLO}	V_{IN} rising	1.85	1.95	2.05	V	3
Maximum Output Current	I_{OUTMAX}		3	-	-	A	1
DC Bias Current	I_q	$V_{OUT}=V_{OUT} \times 1.1V$	-	15	25	μA	2
	I_{SBY}	$V_{CE}=0V$	-	0	1.0	μA	2
Switching Frequency	f_{OSC}	$V_{IN}=5.5V$, $I_{OUT}=300mA$	1	1.2	1.4	Mhz	1
Over-Temperature Threshold			-	155	-	°C	1
Switch ON Resistance, High	R_{PMOS}	$V_{OUT}=0.6V$, $I_{LX}=100mA^{(*)1}$	-	0.08	0.09	Ω	4
Switch ON Resistance, Low ^(**2)	R_{NMOS}		-	0.06	0.07	Ω	
Switching Leakage Current	I_{LeakH}	$V_{IN}=5.5V, V_{CE}=0V$, $V_{OUT}=0V, V_{LX}=5.5V$	-	0.0	3.0	μA	5
	I_{LeakL}	$V_{IN}=5.5V, V_{CE}=0V$, $V_{OUT}=0V, V_{LX}=0V$	-	0.0	1.0	μA	5
Peak Current Limit	I_{LIMH}	$V_{OUT}=0.6V$, I_{LX} until Lx pin oscillates	4.5	4.7	5.2	A	4
Valley Current Limit ^(**2)	I_{LIML}		4.8	5.2	5.5	A	
Enable Input Voltage	V_{CEH}	$V_{OUT}=0.6V$, Applied voltage to V_{CE} , V_{LX} up to "H" level ^(**3)	1.4	-	5.5	V	3
	V_{CEL}	$V_{OUT}=0.6V$, Applied voltage to V_{CE} , V_{LX} down to "L" level ^(**3)	V_{SS}	-	0.3	V	3

Soft-start Time	t _{SS}	After "H" is fed to CE, the time when Lx pin oscillates	0.05	0.3	0.5	mS	3
Short Protection Threshold Voltage	V _{SHORT}	Decrease V _{OUT} voltage when Lx becomes "L" level ^(*3)	0.17	0.27	0.37	V	3
Output Discharge Switch On Resistance	R _{DCHG}	V _{CE} =0V, V _{OUT} =4.0V	150	220	300	Ω	2

Notes: (*1) $R_{PMOS} = (V_{IN} - V_{LX}) / 100mA$

(*2) Design value for the ME3109 series.

(*3) "H"= V_{IN} , "L"= V_{SS}

Test Circuits(ME3109A)

Circuit No.1

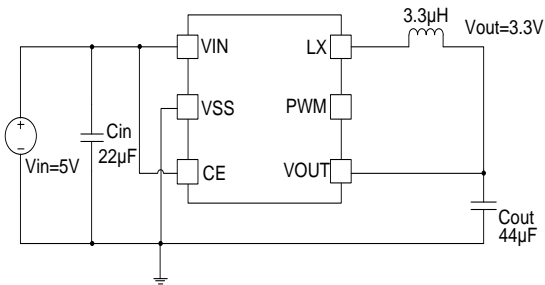

Circuit No.2

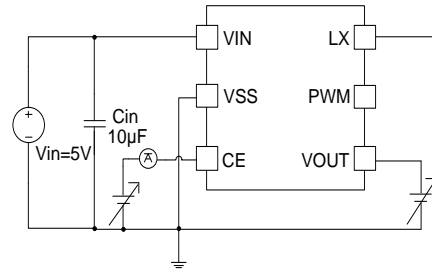

Circuit No.3

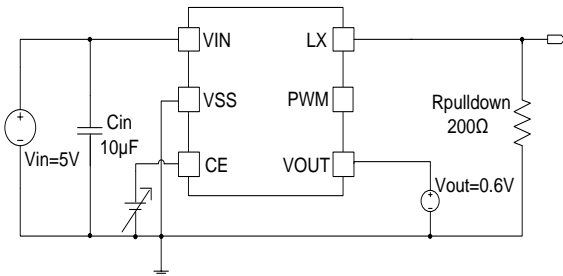

Circuit No.4

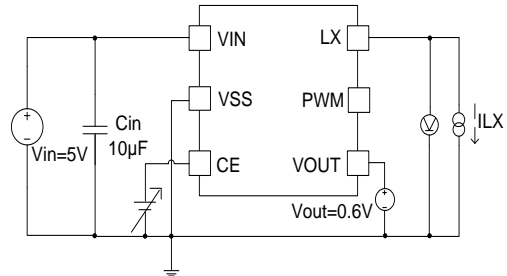

Circuit No.5

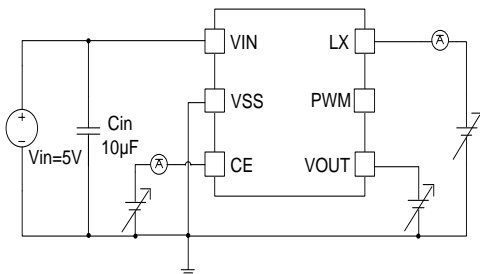

ME3109F test conditions: $V_{IN}=5V$, $V_{PWM}=0V$, $V_{CE}=5V$, $T_{opt}=25^{\circ}C$ unless otherwise noted.

Parameter	Symbol	Condition	Min	Typ	Max	Unit	Circuit
Input Voltage Range	V_{IN}		2.8	-	5.5	V	1
Feedback Voltage	V_{FB}		0.588	0.6	0.612	V	1
UVLO Voltage	V_{UVLO}	$V_{FB}=0V, V_{IN}$ rising	1.85	1.95	2.05	V	3
Maximum Output Current	I_{OUTMAX}		3	-	-	A	1
DC Bias Current	I_q	$V_{FB}=1V$ ME3109FA	-	15	25	μA	2
	I_{SBY}	$V_{CE}=0V$	-	0	1.0	μA	2
Switching Frequency	f_{OSC}	$V_{IN}=5.5V, V_{OUT}=3.3V,$ $I_{OUT}=300mA$	1	1.2	1.4	Mhz	1
Over-Temperature Threshold			-	155	-	$^{\circ}C$	1
Switch ON Resistance, High	R_{PMOS}	$V_{FB}=0V, V_{OUT}=0.6V,$ $I_{LX}=100mA^{(*1)}$	-	0.08	0.09	Ω	4
Switch ON Resistance, Low ^(*2)	R_{NMOS}		-	0.06	0.07	Ω	
Switching Leakage Current	I_{LeakH}	$V_{IN}=5.5V, V_{CE}=0V,$ $V_{OUT}=0V, V_{LX}=5.5V$	-	0.0	3.0	μA	5
	I_{LeakL}	$V_{IN}=5.5V, V_{CE}=0V,$ $V_{OUT}=0V, V_{LX}=0V$	-	0.0	1.0	μA	5
Peak Current Limit	I_{LIMH}	Gradually reduce Rload , monitor peak IL current	4.6	4.7	5.2	A	4
Valley Current Limit ^(*2)	I_{LIML}		4.8	5.2	5.5	A	
Enable Input Voltage	V_{CEH}	$V_{FB}=0V, V_{OUT}=0.6V$, Applied voltage to V_{CE} , V_{LX} up to "H" level ^(*3)	1.4	-	5.5	V	3
	V_{CEL}	$V_{FB}=0V, V_{OUT}=0.6V$, Applied voltage to V_{CE} , V_{LX} down to "L" level ^(*3)	Vss	-	0.3	V	3
Soft-start Time	tss	$V_{FB}=0V$, After "H" is fed to CE, the time when Lx pin oscillates	0.05	0.3	0.5	mS	3
Short Protection Threshold Voltage	V_{SHORT}	$V_{FB}=0V$, Decrease V_{OUT} voltage when Lx becomes "L" level ^(*3)	0.17	0.27	0.37	V	3
Output Discharge Switch On Resistance	R_{DCHG}	$V_{FB}=0V, V_{CE}=0V, V_{OUT}=4.0V$	150	220	300	Ω	2

Notes: (*1) $R_{PMOS} = (V_{IN} - V_{LX}) / 100mA$

(*2) Design value for the ME3109 series.

(*3) "H"= V_{IN} , "L"= V_{SS}

Test Circuits(ME3109F)

Circuit No.1

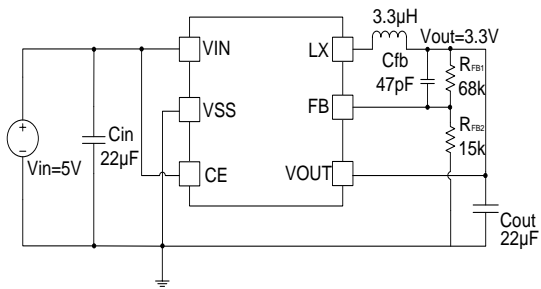

Circuit No.2

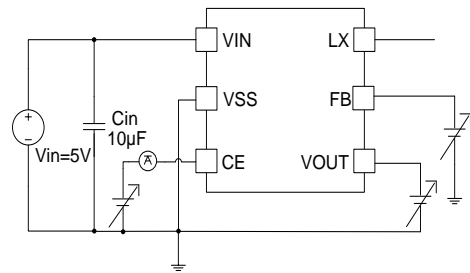

Circuit No.3

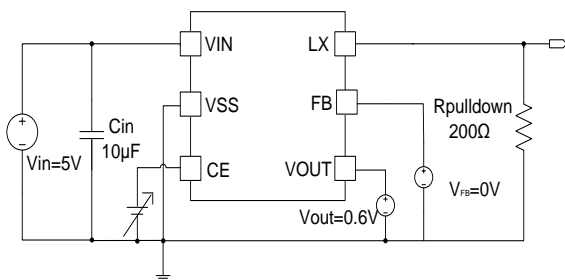

Circuit No.4

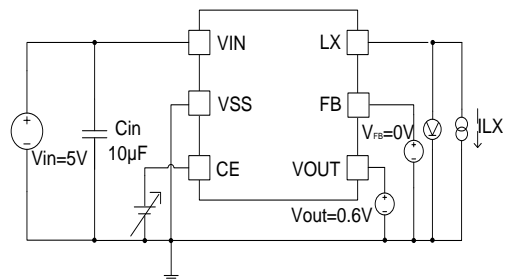

Circuit No.5

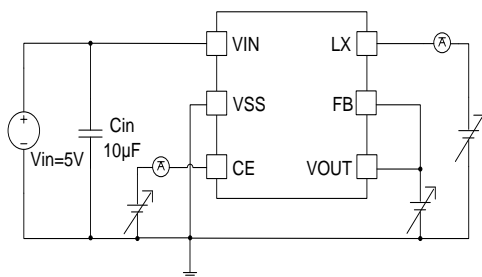

Operation Principles

The ME3109 is a synchronous low voltage step-down DC/DC converter that can support the input voltage range of 2.8V to 5.5V and the output current can be up to 3A(TYP). In normal operation, the high side PMOS is turned on when the switch controller is set by the comparator and is turned off when the Ton comparator resets the switch controller.

The error amplifier EA adjusts COMP voltage by comparing the feedback signal (V_{FB}) from the output voltage with the internal reference. When the load current increases, it causes a drop in the feedback voltage relative to the reference, then the COMP voltage rises to allow higher inductor current to match the load current.

Soft start

An internal current source charges an internal capacitor to build the soft-start ramp voltage. The V_{FB} voltage will track the reference voltage during soft-start interval. The typical soft-start time is 0.3ms.

PWM/PFM auto selection

The ME3109FA operates in both discontinuous mode (PFM) and continuous mode (PWM) modes depending on the load. It adopts PFM mode in light load, PWM mode in heavy load. So the ME3108 could acquire high efficiency in all over the loads.

PWM

ME3109A, connect PWM to GND, select chip to work in PWM / PFM automatic switching mode; or connect PWM to Vin, select chip to work in forced continuous mode.

Enable

A logic-high enables the converter; a logic-low forces the device into shutdown mode.

UVLO

If the V_{IN} lower than threshold voltage 1.95V (TYP), the UV comparator's output will go high and the switch controller will turn off the high side MOSFET. If the V_{IN} higher than 2V (typical value), the controller will resume the working state.

Over temperature protection (OTP)

The ME3109 implements an internal thermal shutdown function when the junction temperature exceeds 150°C (TYP). The thermal shutdown forces the device to stop switching when the junction temperature exceeds the thermal shutdown threshold. Once the temperature decreases below the hysteresis of 30°C (TYP), the device works again.

Short-circuit protection function

The ME3109 has short-circuit protection function. When the load is shorted or the load current is huge making

the output voltage below 0.27V (TYP), it enters into shutdown mode and couldn't work again except restart the CE pin or the V_{IN} pin.

Over Current Protection (OCP)

The ME3109 provides over current protection by detecting the high side MOSFET and the low side MOSFET. When the peak current over 4.7A (TYP), the OCP will be triggered. When the OCP is triggered, the ME3109 will turn off the high side MOSFET immediately; or the valley current reached the limit value 5.2A (TYP), it turns off the low side MOSFET immediately. If current lower than the threshold, the device works normally otherwise might cause the short-circuit protection.

Output Discharge

The ME3109 integrates output voltage high speed discharge function. When the ME3109 is shutdown, the output voltage will be discharged via the device internal.

Typical Performance Characteristics

I_{out} vs Efficiency (V_{out}=3.3V)

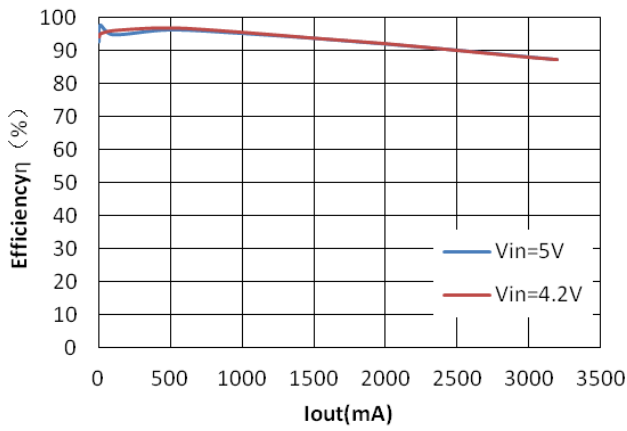

I_{out} vs V_{out} (V_{out}=3.3V)

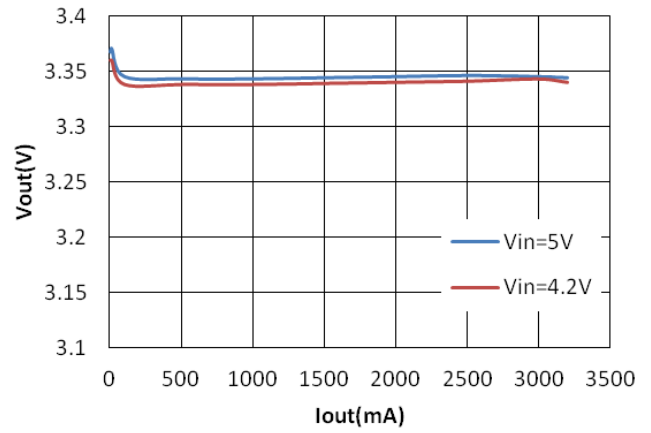

I_{out} vs Efficiency (V_{out}=2.5V)

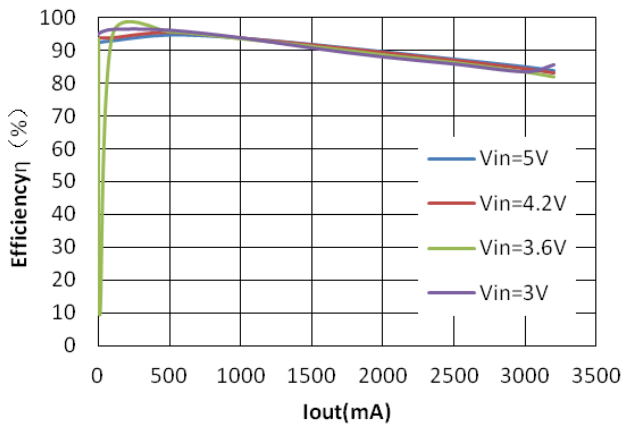

I_{out} vs V_{out} (V_{out}=2.5V)

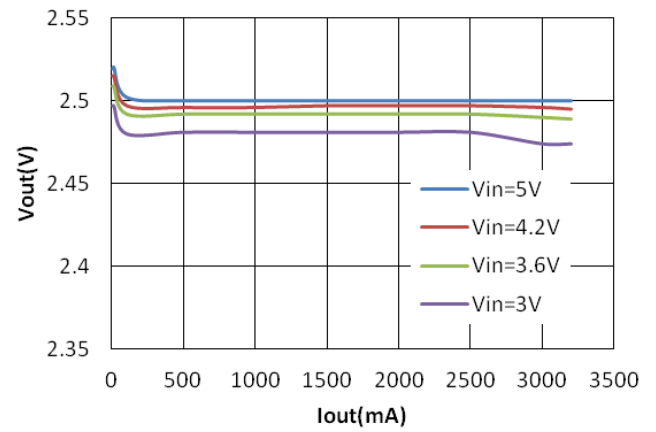

I_{out} vs Efficiency (V_{out}=1.8V)

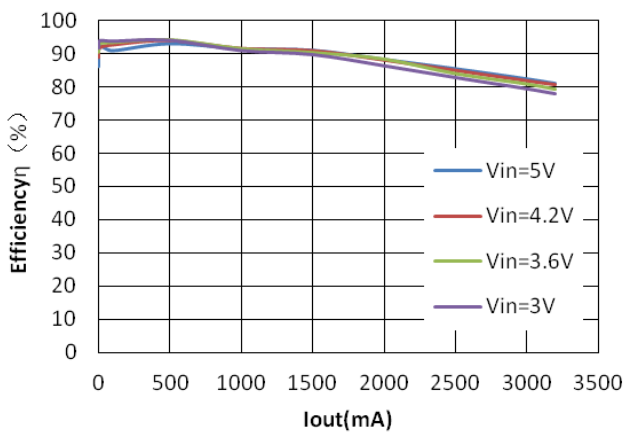

I_{out} vs V_{out} (V_{out}=1.8V)

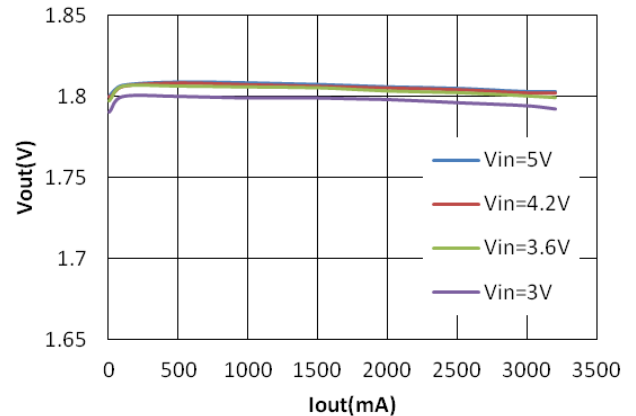

Iout vs Efficiency(Vout=1.2V)

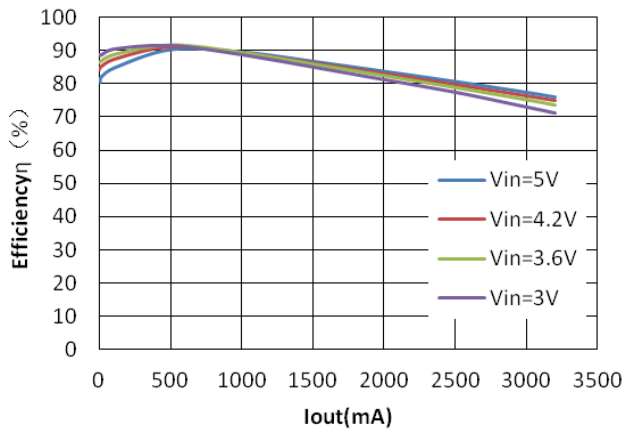

Iout vs Vout(Vout=1.2V)

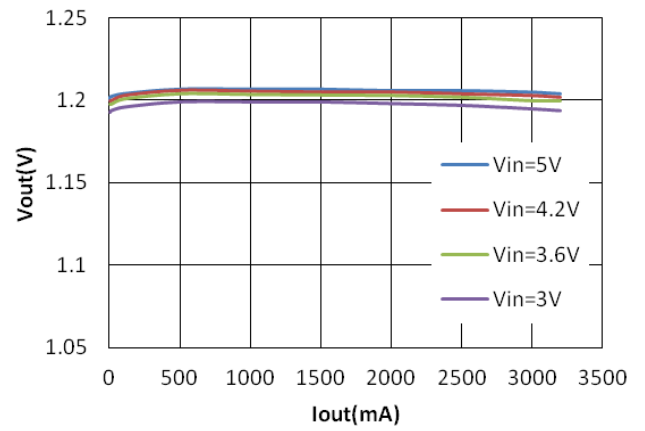

Temperature VS Vout

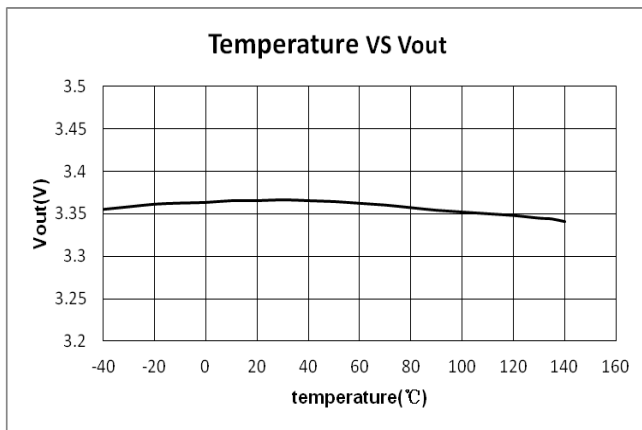

ME3109's COT fast transient response

ME3109 has fast transient response because of the using of COT control. It only needs 25 μ S to resume the output voltage, when the load changes from 200mA to 2.5A. The maximum uprush and undershoot amplitude are about 300mV and they would not effect the load's normal working. ME3109 is especially suitable for applications with strict load response requirements.

Conditions: $T_a=25^{\circ}\text{C}$, $V_{in}=5\text{V}$, $V_{out}=3.3\text{V}$, $I_{out}=180\text{mA}\rightarrow 2.5\text{A}$. $L=3.3\mu\text{H}$, $R_{FB1}=68\text{k}$, $R_{FB2}=15\text{k}$, $C_{FB}=47\text{pF}$, $C_{in}=22\mu\text{F}$ (ceramics), $C_{out}=44\mu\text{F}$ (ceramics)

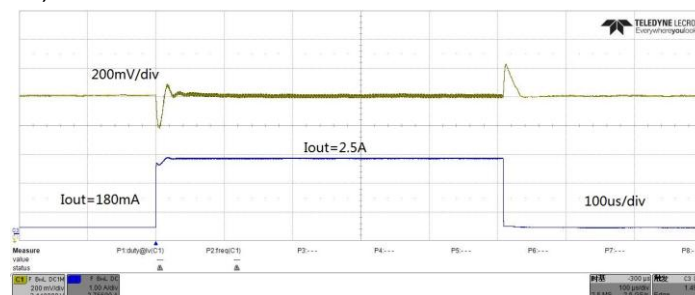

Conditions: $T_a=25^{\circ}\text{C}$, $V_{in}=5\text{V}$, $V_{out}=2.5\text{V}$, $I_{out}=180\text{mA}\rightarrow 2.5\text{A}$. $L=3.3\mu\text{H}$, $R_{FB1}=47\text{k}$, $R_{FB2}=15\text{k}$, $C_{FB}=47\text{pF}$, $C_{in}=22\mu\text{F}$ (ceramics), $C_{out}=44\mu\text{F}$ (ceramics)

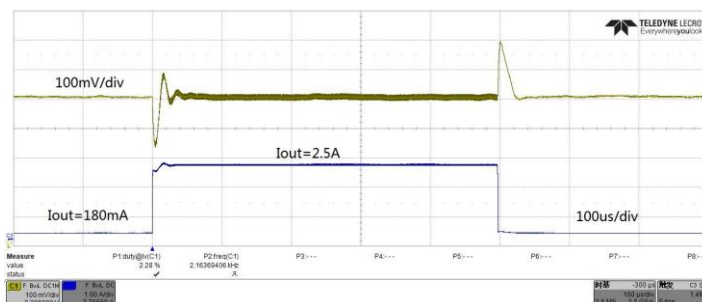

Conditions: $T_a=25^{\circ}\text{C}$, $V_{in}=5\text{V}$, $V_{out}=1.8\text{V}$, $I_{out}=180\text{mA}\rightarrow 2.5\text{A}$. $L=3.3\mu\text{H}$, $R_{FB1}=30\text{k}$, $R_{FB2}=15\text{k}$, $C_{FB}=47\text{pF}$, $C_{in}=22\mu\text{F}$ (ceramics), $C_{out}=44\mu\text{F}$ (ceramics)

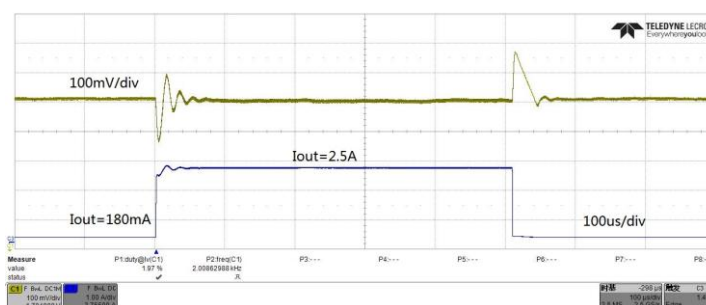

Conditions: $T_a=25^{\circ}\text{C}$, $V_{in}=5\text{V}$, $V_{out}=1.2\text{V}$, $I_{out}=180\text{mA}\rightarrow 2.5\text{A}$. $L=3.3\mu\text{H}$, $R_{FB1}=91\text{k}$, $R_{FB2}=91\text{k}$, $C_{FB}=47\text{pF}$, $C_{in}=22\mu\text{F}$ (ceramics), $C_{out}=44\mu\text{F}$ (ceramics)

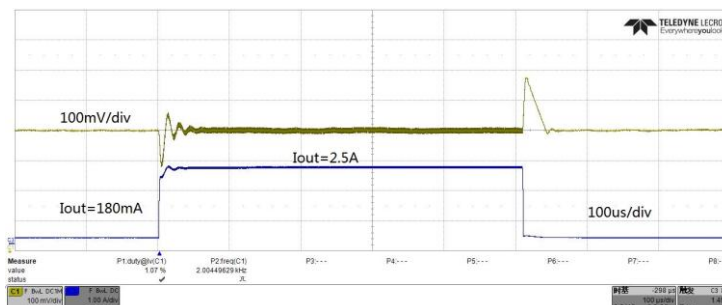

Package Information

- Packaging Type: DFN2*2-6L

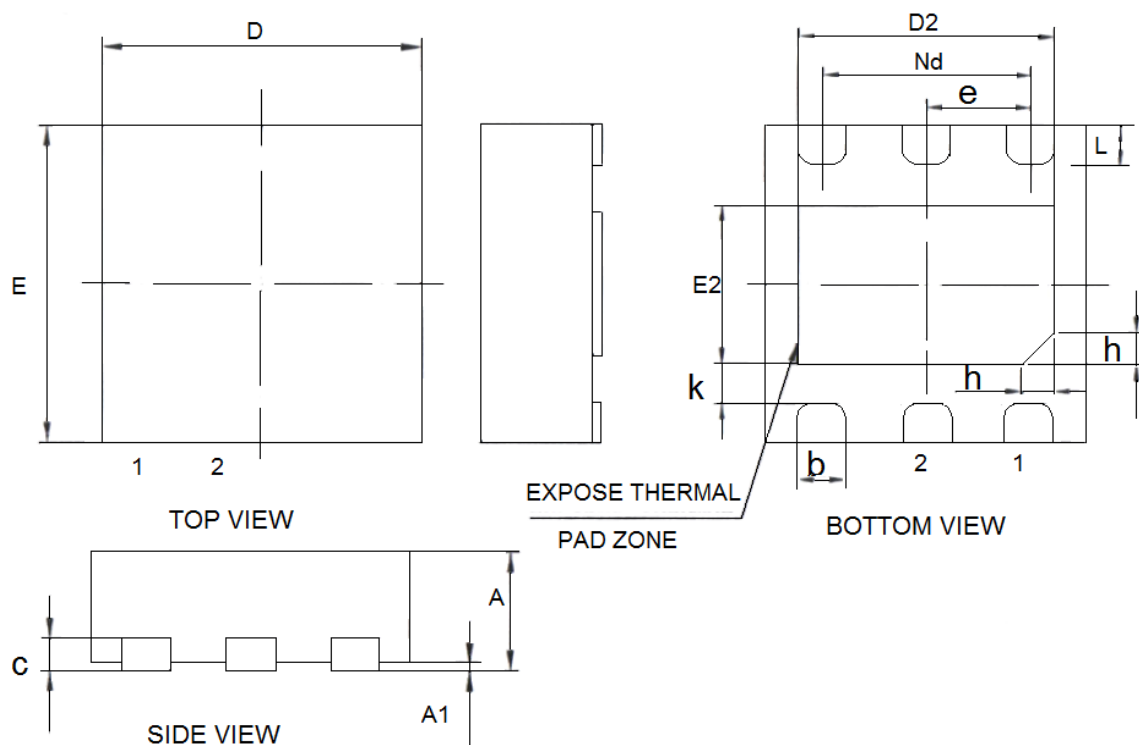

DIM	Millimeters		Inches	
	Min	Max	Min	Max
A	0.7	0.8	0.0276	0.0315
A1	0	0.05	0	0.002
c	0.18	0.25	0.0071	0.0098
b	0.25	0.35	0.0098	0.0138
D	1.9	2.1	0.0748	0.0827
Nd	1.3(TYP)		0.0512(TYP)	
E	1.9	2.1	0.0748	0.0827
E2	0.9	1.1	0.0354	0.0433
e	0.65(TYP)		0.0256(TYP)	
L	0.2	0.3	0.0079	0.0118
h	0.15	0.25	0.0059	0.0098
D2	1.5	1.7	0.0591	0.0669
K	0.2	0.3	0.0079	0.0118

- The contents of this document will be updated with the product's improvement without prior notice. Please consult our sales staff before using this document to ensure that you are using the latest version.
- The application circuit examples described in this document are only used to indicate the representative use of the product and do not guarantee the design of mass production.
- Please use this product within the limits stated in this document. We will not be responsible for any damage caused by improper use.
- The products described in this document are not allowed to be used in equipment or devices that affect the human body without the written permission of our company, including but not limited to: health equipment, medical equipment, disaster prevention equipment, fuel control equipment, automobile equipment, aviation equipment and vehicle equipment.
- Although our company has always been committed to improving product quality and reliability, semiconductor products have a certain probability of malfunction or wrong work. To prevent personal injury or property damage caused by such accidents, please pay full attention to safety design, for example: Alternate design, fire protection design, and prevention of wrong action design.
- When exporting this product or this document overseas, you should abide by applicable import and export control laws.
- Copying or reprinting part or all of this document in any form without the permission of our company is strictly prohibited.