



1A Adjustable Voltage High Speed LDO Regulators ME6118 Series

General Description

The ME6118 series are highly accurate, low noise, LDO Voltage Regulators that are capable of providing an output current that is in excess of 1A with a maximum dropout voltage of 1.3V at 1A (ME6118A33). This series contains four fixed output voltages of 1.2V, 1.8V, 2.5V and 3.3V that have no minimum load requirement to maintain regulation. On chip trimming adjusts the reference/output voltage to within $\pm 2\%$ accuracy. Internal protection features consist of output current limiting, safe operating area compensation, and thermal shutdown. The ME6118 series can operate with up to 18V input.

Features

- Output Current in Excess of 1A
- Dropout Voltage: 80mV @ $I_{OUT} = 100\text{mA}$ (ME6118A33)
- Operating Voltage Range: 2.5V ~ 18V
- Highly Accuracy: $\pm 2\%$
- Adjustable Output Voltage Option
- Standby Current: 52uA (TYP.)
- High Ripple Rejection: 70dB @ 1KHz (ME6118A33)
- Line Regulation: 2mV (TYP.)
- Temperature Stability $\leq 0.5\%$
- Thermal Shutdown Protection: 160°C

Typical Application

- Consumer and Industrial Equipment Point of Regulation
- Switching Power Supply Post Regulation
- Hard Drive Controllers
- Battery Chargers

Package

- 3-pin SOT223, SOT23-3

Typical Application Circuit

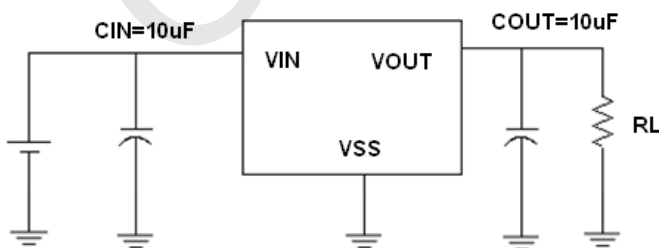



Selection Guide

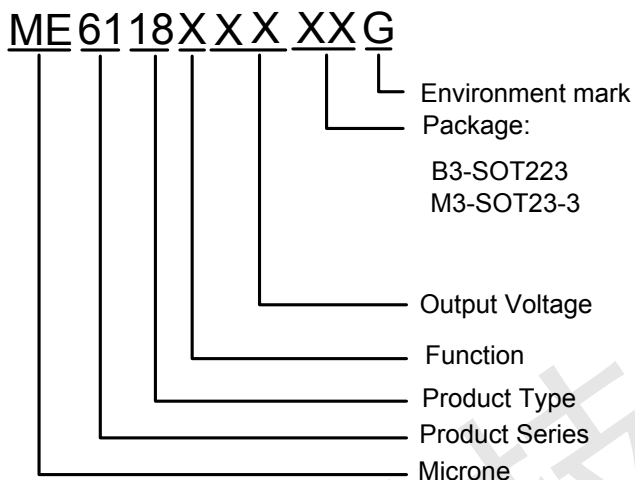

product series	product description
ME6118A12B3G	V _{OUT} =1.2V; Package: SOT223
ME6118A18B3G	V _{OUT} =1.8V; Package: SOT223
ME6118A25B3G	V _{OUT} =2.5V; Package: SOT223
ME6118A33B3G	V _{OUT} =3.3V; Package: SOT223
ME6118A50B3G	V _{OUT} =5.0V; Package: SOT223
ME6118E25B3G	V _{OUT} =2.5V; Package: SOT223; Different pin
ME6118E33B3G	V _{OUT} =3.3V; Package: SOT223; Different pin
ME6118A33M3G	V _{OUT} =3.3V; Package: SOT23-3



Pin Configuration

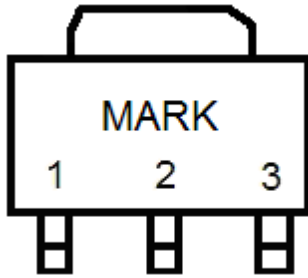

SOT223



SOT23-3

Pin Assignment

ME6118AXX

Pin Number		Pin Name	Functions
SOT223	SOT23-3		
1	1	GND	Ground
2	2	V _{OUT}	Output
3	3	V _{IN}	Power Input

ME6118EXX

Pin Number		Pin Name	Functions
SOT223			
1		GND	Ground
2		V _{IN}	Power Input
3		V _{OUT}	Output

Absolute Maximum Ratings

Parameter	Symbol	Ratings	Units
Input Voltage	V _{IN}	18	V
Output Current	I _{OUT}	1.1	A
Output Voltage	V _{OUT}	V _{SS} -0.3~V _{IN} +0.3	V
Power Dissipation	SOT223	750	mW
	SOT23-3	300	
Operating Temperature Range	T _{OPR}	-40~+125	°C
Storage Temperature Range	T _{STG}	-40~+150	°C
Lead Temperature		260°C, 4sec	



Block Diagram

ME6118

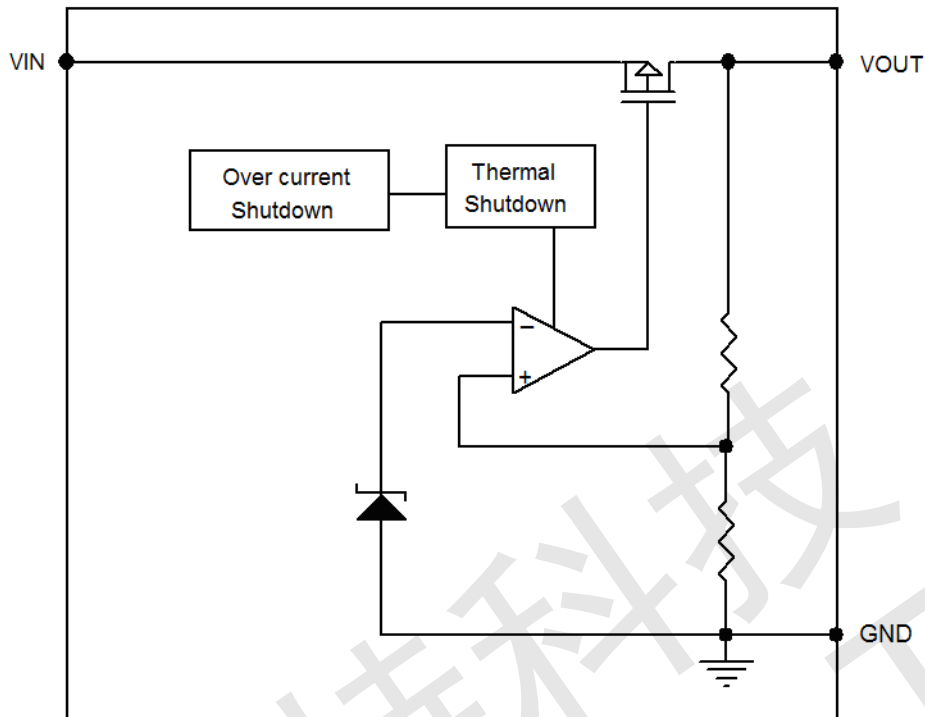

Electrical Characteristics

ME6118A12/E12 (Packages:SOT223)

($V_{IN} = V_{OUT} + 1.3V$, $C_{IN} = C_L = 10\mu F$, $T_a = 25^\circ C$, unless otherwise noted)

Parameter	Symbol	Conditions	Min.	Typ.	Max.	Units
Output Voltage	$V_{OUT}(E)$ (Note 2)	$I_{OUT} = 10mA$, $V_{IN} = V_{OUT} + 1.3V$	X 0.98	$V_{OUT}(T)$ (Note 1)	X 1.02	V
Maximum Output Current	I_{OUTMAX}	$V_{IN} = V_{OUT} + 1.3V$		800		mA
Load Regulation	ΔV_{OUT}	$V_{IN} = V_{OUT} + 1.3V$, $1mA \leq I_{OUT} \leq 800mA$		3		mV
Dropout Voltage (Note 3)	V_{DIF1}	$I_{OUT} = 100mA$		195		mV
	V_{DIF2}	$I_{OUT} = 400mA$		665		mV
	V_{DIF3}	$I_{OUT} = 800mA$		1250		mV
	V_{DIF4}	$I_{OUT} = 1000mA$		1600		mV
Quiescent Current	I_{ss}	$V_{IN} = V_{OUT} + 1.3V$		53		μA
Line Regulation	ΔV_{OUT}	$I_{OUT} = 0mA$ $V_{OUT} + 1.3V \leq V_{IN} \leq 18V$		2		mV
Thermal Shutdown Protection	T_{sd}	$I_{OUT} = 10mA$, $V_{IN} = V_{OUT} + 1.3V$		155		$^\circ C$
Over Current Protection	I_{limit}	$V_{IN} = 3V$		1.1		A



ME6118A18/E18 (Packages:SOT223)

ME6118

($V_{IN} = V_{OUT} + 1.2V$, $C_{IN} = C_L = 10\mu F$, $T_a = 25^\circ C$, unless otherwise noted)

Parameter	Symbol	Conditions	Min.	Typ.	Max.	Units
Output Voltage	$V_{OUT}(E)$ (Note 2)	$I_{OUT} = 10mA$ $V_{IN} = V_{OUT} + 1.2V$	X 0.98	$V_{OUT}(T)$ (Note 1)	X 1.02	V
Maximum Output Current	I_{OUTMAX}	$V_{IN} = V_{OUT} + 1.2V$		800		mA
Load Regulation	ΔV_{OUT}	$V_{IN} = V_{OUT} + 1.2V$, $1mA \leq I_{OUT} \leq 800mA$		5		mV
Dropout Voltage (Note 3)	V_{DIF1}	$I_{OUT} = 100mA$		115		mV
	V_{DIF2}	$I_{OUT} = 400mA$		450		mV
	V_{DIF3}	$I_{OUT} = 800mA$		940		mV
	V_{DIF4}	$I_{OUT} = 1000mA$		1600		mV
Quiescent Current	I_{SS}	$V_{IN} = V_{OUT} + 1.2V$		52		μA
Line Regulation	ΔV_{OUT}	$I_{OUT} = 0mA$ $V_{OUT} + 1.2V \leq V_{IN} \leq 18V$		2		mV
Thermal Shutdown Protection	T_{SD}	$I_{OUT} = 10mA$ $V_{IN} = V_{OUT} + 1.2V$		160		$^\circ C$
Over Current Protection	I_{LIMIT}	$V_{IN} = 3.5V$		1.1		A

ME6118A25/E25 (Packages:SOT223)

($V_{IN} = V_{OUT} + 1.2V$, $C_{IN} = C_L = 10\mu F$, $T_a = 25^\circ C$, unless otherwise noted)

Parameter	Symbol	Conditions	Min.	Typ.	Max.	Units
Output Voltage	$V_{OUT}(E)$ (Note 2)	$I_{OUT} = 10mA$, $V_{IN} = V_{OUT} + 1.2V$	X 0.98	$V_{OUT}(T)$ (Note 1)	X 1.02	V
Maximum Output Current	I_{OUTMAX}	$V_{IN} = V_{OUT} + 1.2V$		800		mA
Load Regulation	ΔV_{OUT}	$V_{IN} = V_{OUT} + 1.2V$, $1mA \leq I_{OUT} \leq 800mA$		5		mV
Dropout Voltage (Note 3)	V_{DIF1}	$I_{OUT} = 100mA$		90		mV
	V_{DIF2}	$I_{OUT} = 500mA$		450		mV
	V_{DIF3}	$I_{OUT} = 800mA$		790		mV
	V_{DIF4}	$I_{OUT} = 1000mA$		1300		mV
Quiescent Current	I_{SS}	$V_{IN} = V_{OUT} + 1.2V$		53		μA
Line Regulation	ΔV_{OUT}	$I_{OUT} = 0mA$ $V_{OUT} + 1.2V \leq V_{IN} \leq 18V$		2		mV
Thermal Shutdown Protection	T_{SD}	$I_{OUT} = 10mA$, $V_{IN} = V_{OUT} + 1.2V$		160		$^\circ C$
Over Current Protection	I_{LIMIT}	$V_{IN} = 4.0V$		1.1		A



ME6118A33/E33 (Packages:SOT223)

ME6118

($V_{IN}=V_{OUT}+1.2V$, $C_{IN}=C_L=10\mu F$, $T_a=25^{\circ}C$, unless otherwise noted)

Parameter	Symbol	Conditions	Min.	Typ.	Max.	Units
Output Voltage	$V_{OUT}(E)$ (Note 2)	$I_{OUT}=10mA$, $V_{IN}=V_{OUT}+1.2V$	X 0.98	$V_{OUT}(T)$ (Note 1)	X 1.02	V
Maximum Output Current	I_{OUTMAX}	$V_{IN}=V_{OUT}+1.2V$		800		mA
Load Regulation	ΔV_{OUT}	$V_{IN}=V_{OUT}+1.2V$, $1mA \leq I_{OUT} \leq 800mA$		7		mV
Dropout Voltage (Note 3)	V_{DIF1}	$I_{OUT}=100mA$		80		mV
	V_{DIF2}	$I_{OUT}=500mA$		400		mV
	V_{DIF3}	$I_{OUT}=800mA$		680		mV
	V_{DIF4}	$I_{OUT}=1000mA$		1300		mV
Quiescent Current	I_{SS}	$V_{IN}=V_{OUT}+1.2V$		53		μA
Line Regulation	ΔV_{OUT}	$I_{OUT}=0mA$ $V_{OUT}+1.2V \leq V_{IN} \leq 18V$		2		mV
Thermal Shutdown Protection	T_{SD}	$I_{OUT}=10mA$, $V_{IN}=V_{OUT}+1.2V$		160		$^{\circ}C$
Over Current Protection	I_{LIMIT}	$V_{IN}=5.0V$		1.1		A

ME6118A33 (Package: SOT23-3)

($V_{IN}=V_{OUT}+1.2V$, $C_{IN}=C_L=10\mu F$, $T_a=25^{\circ}C$, unless otherwise noted)

Parameter	Symbol	Conditions	Min.	Typ.	Max.	Units
Output Voltage	$V_{OUT}(E)$ (Note 2)	$I_{OUT}=10mA$, $V_{IN}=V_{OUT}+1.2V$	X 0.98	$V_{OUT}(T)$ (Note 1)	X 1.02	V
Maximum Output Current	I_{OUTMAX}	$V_{IN}=V_{OUT}+1.2V$		500	600	mA
Load Regulation	ΔV_{OUT}	$V_{IN}=V_{OUT}+1.2V$, $1mA \leq I_{OUT} \leq 500mA$		10		mV
Dropout Voltage (Note 3)	V_{DIF1}	$I_{OUT}=100mA$		70		mV
	V_{DIF2}	$I_{OUT}=300mA$		220		mV
	V_{DIF3}	$I_{OUT}=500mA$		385		mV
Quiescent Current	I_{SS}	$V_{IN}=V_{OUT}+1.2V$		53		μA
Line Regulation	ΔV_{OUT}	$I_{OUT}=0mA$ $V_{OUT}+1.2V \leq V_{IN} \leq 18V$		2		mV
Thermal Shutdown Protection	T_{SD}	$I_{OUT}=10mA$, $V_{IN}=V_{OUT}+1.2V$		160		$^{\circ}C$
Over Current Protection	I_{LIMIT}	$V_{IN}=5.0V$		1.1		A



ME6118A50/E50 (Packages:SOT223)

ME6118

($V_{IN} = V_{OUT} + 1.2V$, $C_{IN} = C_L = 10\mu F$, $T_a = 25^\circ C$, unless otherwise noted)

Parameter	Symbol	Conditions	Min.	Typ.	Max.	Units
Output Voltage	$V_{OUT}(E)$ (Note 2)	$I_{OUT} = 10mA$, $V_{IN} = V_{OUT} + 1.2V$	X 0.98	$V_{OUT}(T)$ (Note 1)	X 1.02	V
Maximum Output Current	I_{OUTMAX}	$V_{IN} = V_{OUT} + 1.2V$		800		mA
Load Regulation	ΔV_{OUT}	$V_{IN} = V_{OUT} + 1.2V$, $1mA \leq I_{OUT} \leq 800mA$		8		mV
Dropout Voltage (Note 3)	V_{DIF1}	$I_{OUT} = 100mA$		60		mV
	V_{DIF2}	$I_{OUT} = 500mA$		300		mV
	V_{DIF3}	$I_{OUT} = 800mA$		500		mV
	V_{DIF4}	$I_{OUT} = 1000mA$		900		mV
Quiescent Current	I_{SS}	$V_{IN} = V_{OUT} + 1.2V$		53		μA
Line Regulation	ΔV_{OUT}	$I_{OUT} = 0mA$ $V_{OUT} + 1.2V \leq V_{IN} \leq 18V$		2		mV
Thermal Shutdown Protection	T_{SD}	$I_{OUT} = 10mA$, $V_{IN} = V_{OUT} + 1.2V$		160		$^\circ C$
Over Current Protection	I_{LIMIT}	$V_{IN} = 6.5V$		1.1		A

Note :

- $V_{OUT}(T)$: Specified Output Voltage
- $V_{OUT}(E)$: Effective Output Voltage (ie. The output voltage when " $V_{OUT}(T) + 1.2V$ " is provided at the V_{IN} pin while maintaining a certain I_{OUT} value.)
- V_{DIF} : $V_{IN1} - V_{OUT}(E)$
 V_{IN1} : The input voltage when $V_{OUT}(E)$ appears as input voltage is gradually decreased.
 $V_{OUT}(E)$ = A voltage equal to 98% of the output voltage whenever an amply stabilized I_{OUT} and $\{V_{OUT}(T) + 1.2V\}$ is input.



Type Characteristics

(1) Output Voltage VS. Output Current

ME6118A12B3G (VIN=VOUT+1.3V)

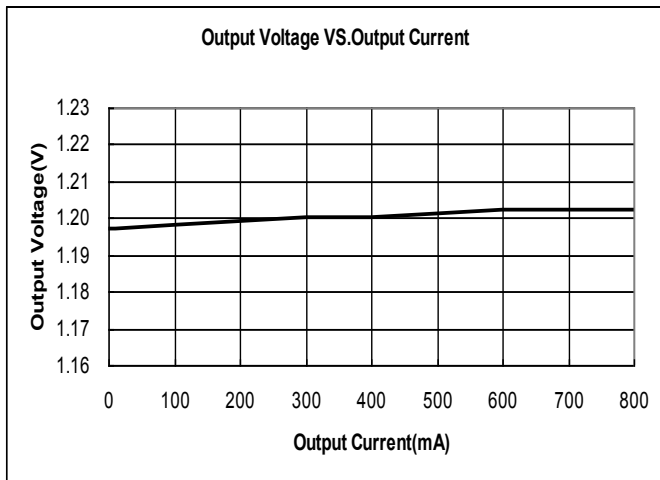

ME6118A18B3G (VIN=VOUT+1.2V)

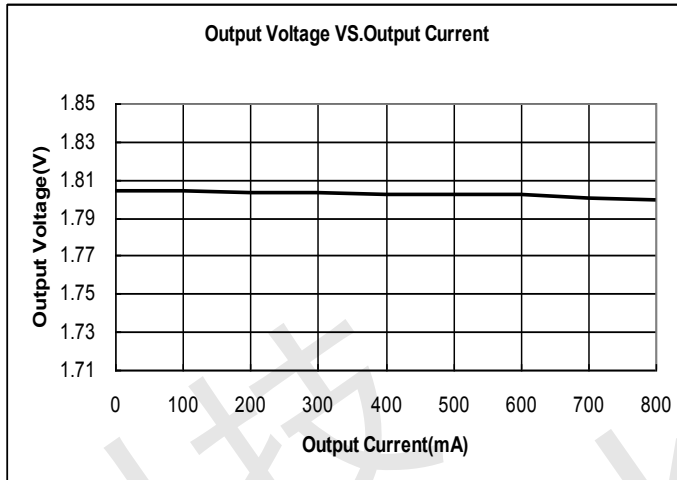

ME6118A25B3G (VIN=VOUT+1.2V)

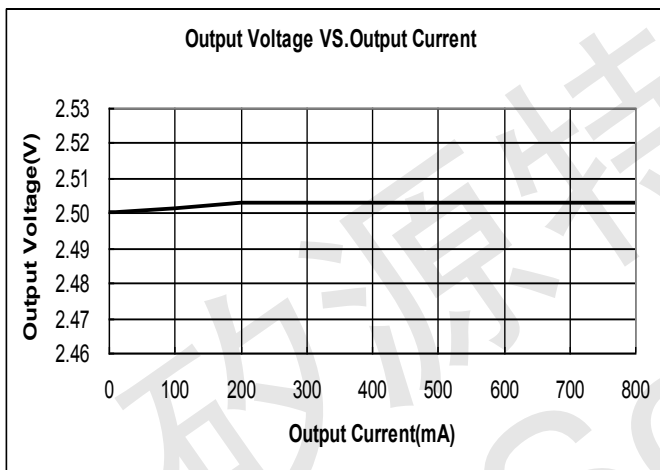

ME6118A33B3G (VIN=VOUT+1.2V)

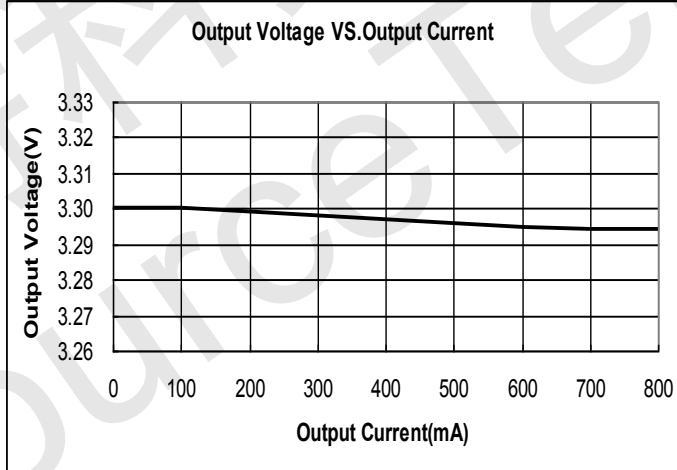

(2) Output Voltage VS. Temperature

ME6118A12B3G (VIN=VOUT+1.3V, IOUT=10mA)

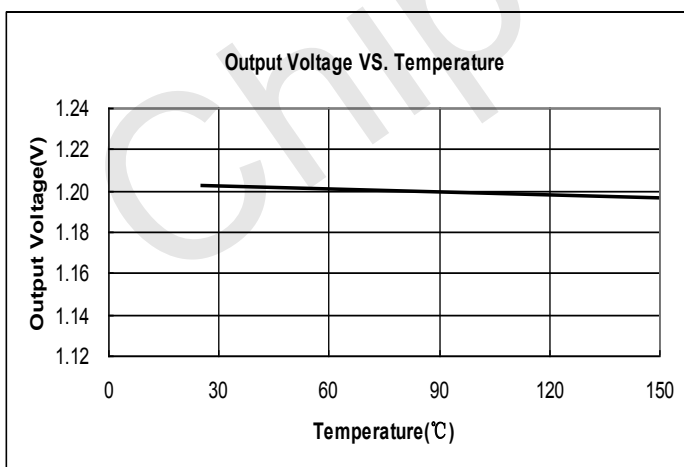

ME6118A18B3G (VIN=VOUT+1.2V, IOUT=10mA)

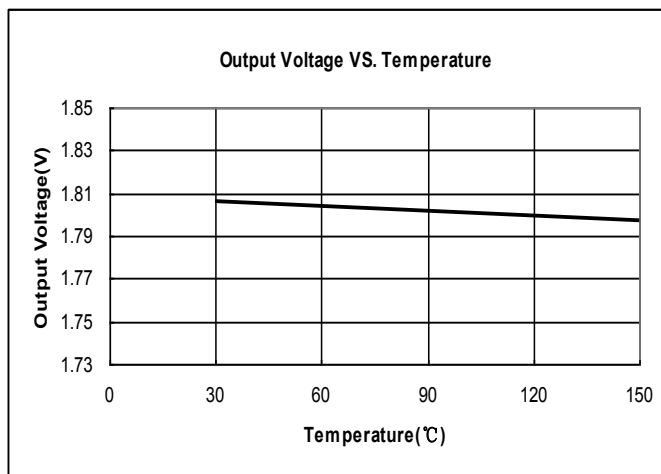



ME6118

ME6118A25B3G (VIN=V_{OUT}+1.2V, I_{OUT}=10mA)

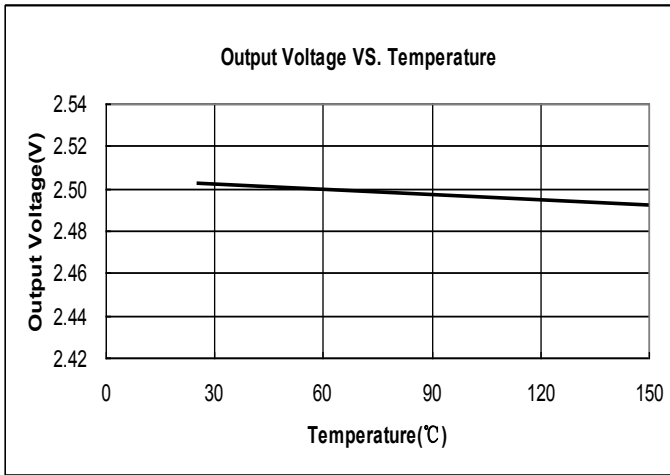

ME6118A33B3G (VIN=V_{OUT}+1.2V, I_{OUT}=10mA)

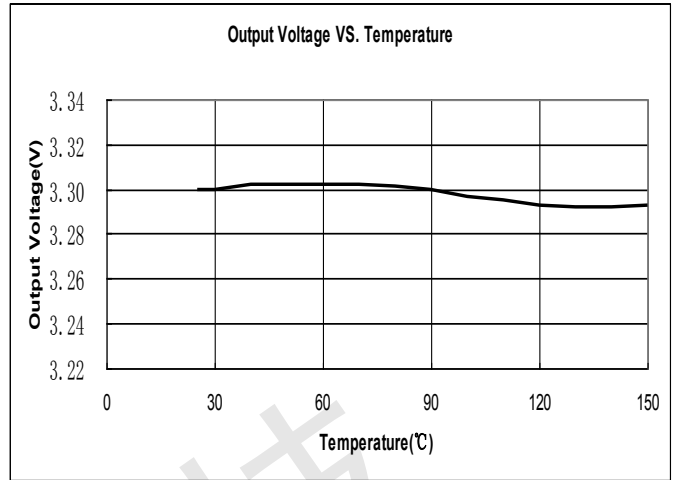

(3) Dropout Voltage VS. Output Current (Ta = 25 °C)

ME6118A12B3G

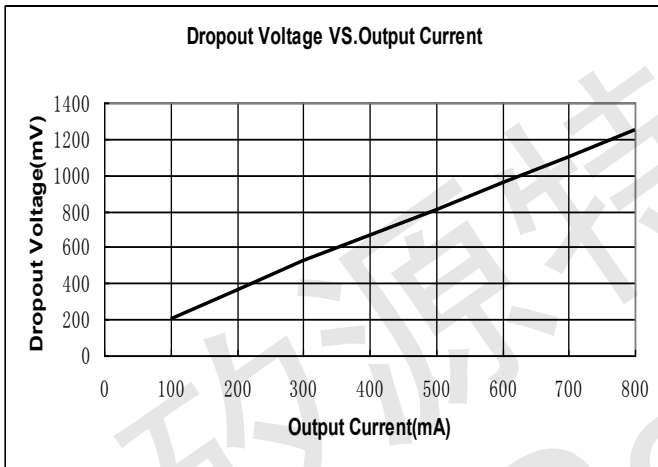

ME6118A18B3G

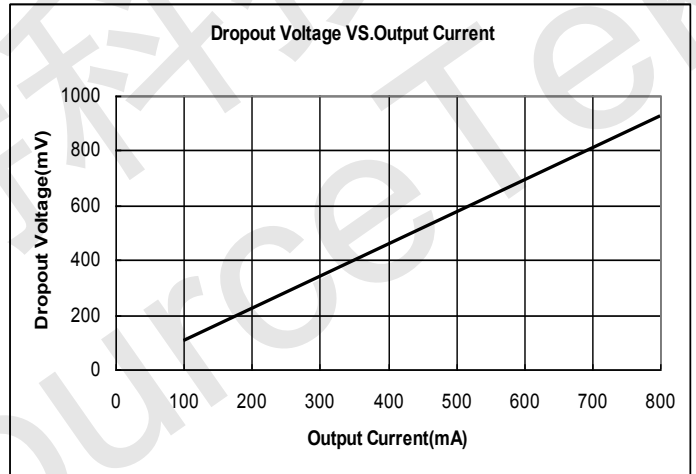

ME6118A25B3G

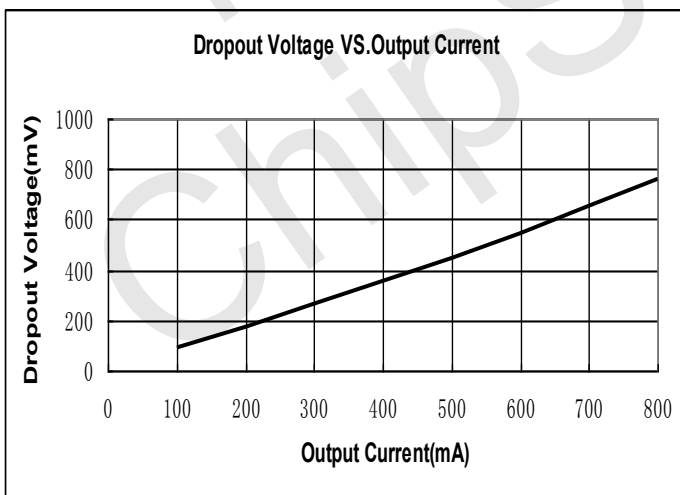

ME6118A33B3G

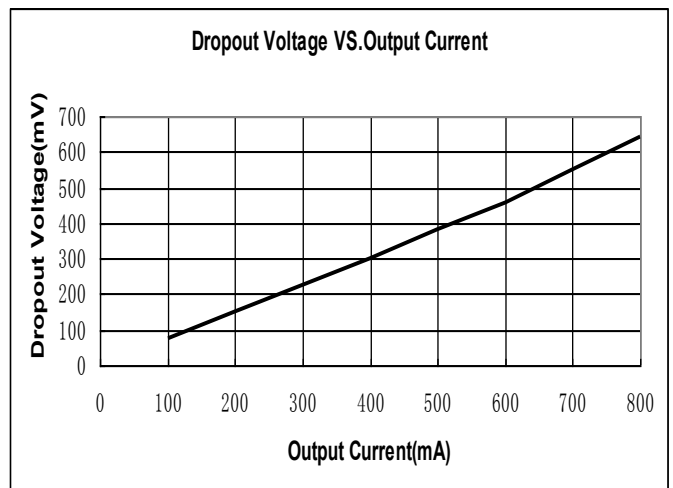



(4) Output Voltage VS. Input Voltage (Ta = 25 °C)

ME6118A12B3G

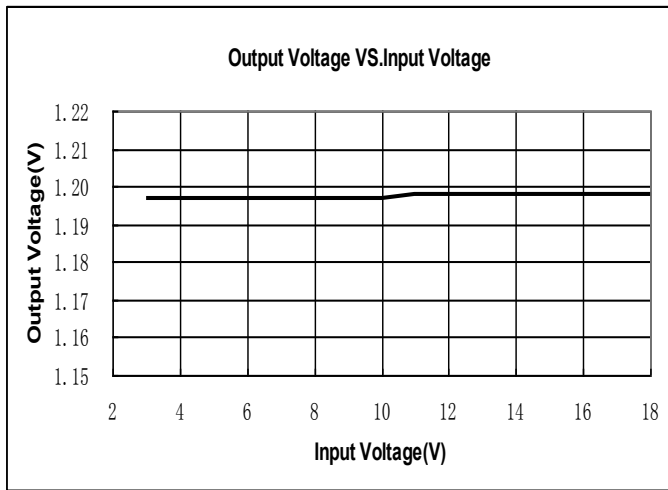

ME6118A18B3G

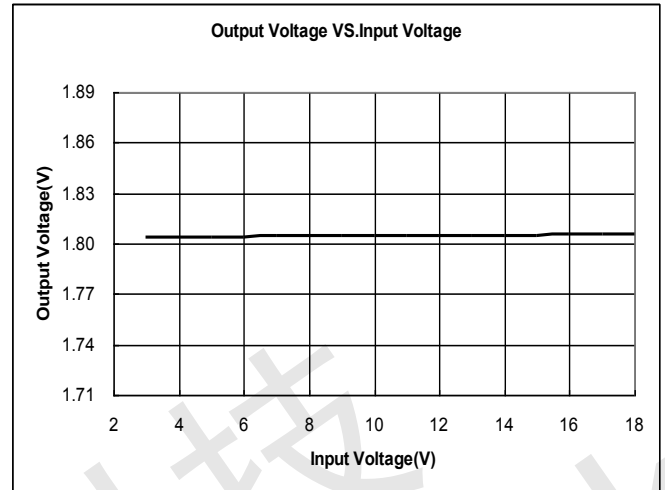

ME6118A25B3G

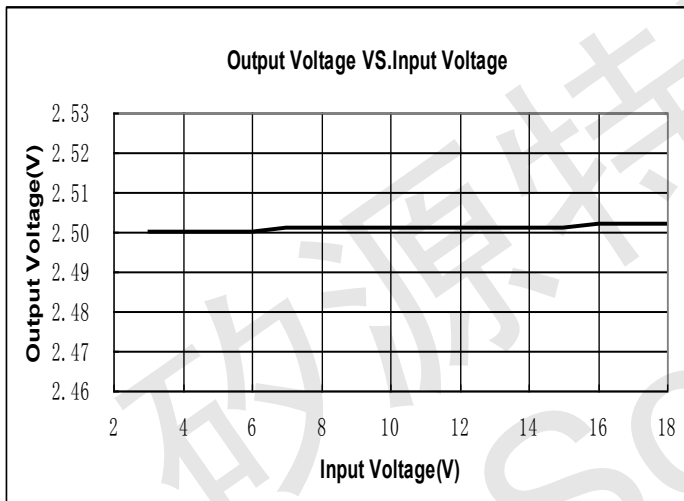

ME6118A33B3G

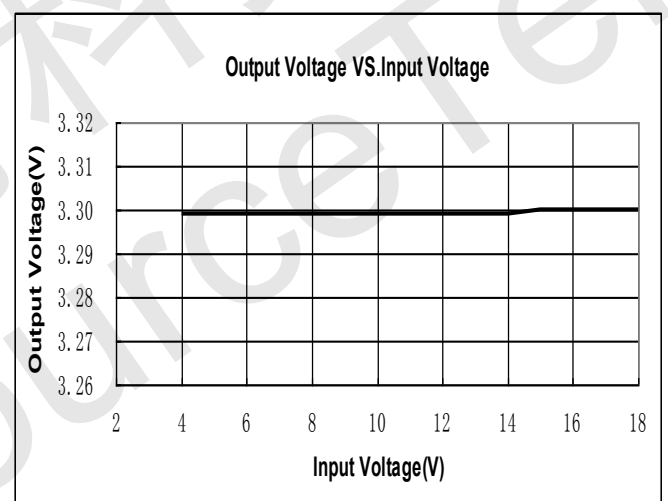

(5) Quiescent Current VS. Input Voltage

ME6118A12B3G

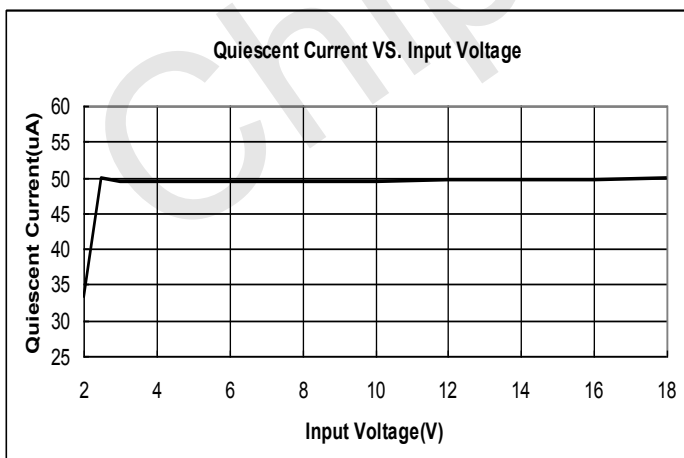

ME6118A18B3G

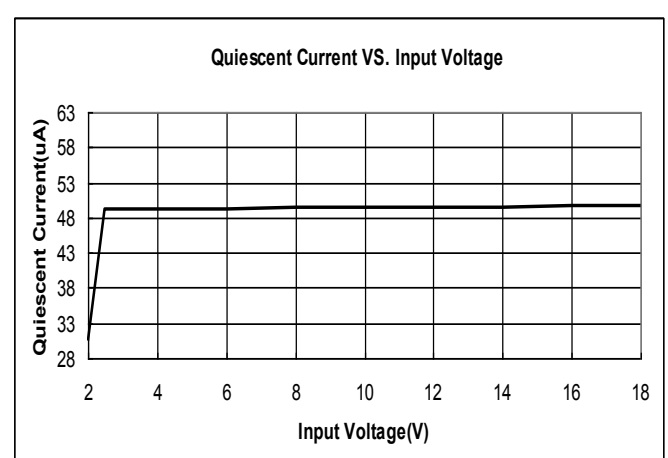



ME6118A25B3G

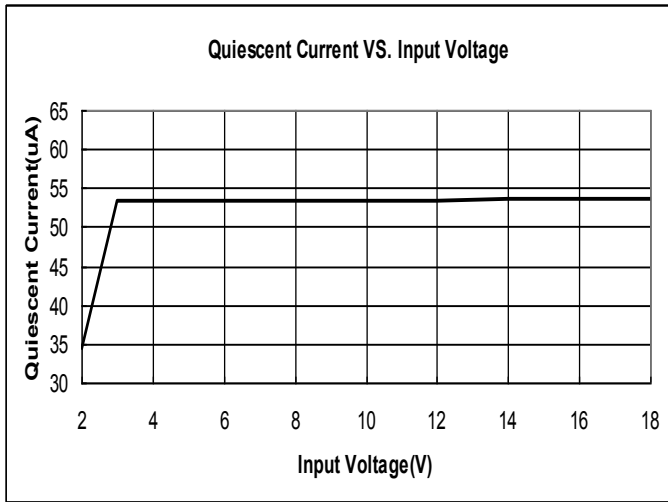

ME6118A33B3G

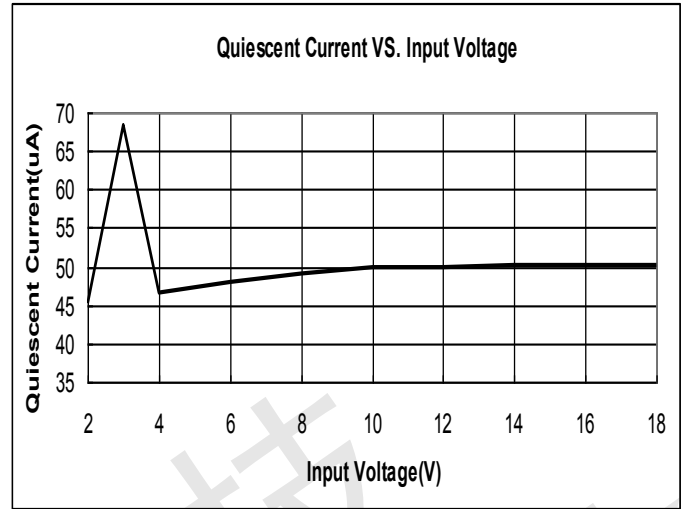

ME6118

Applications Information

1. Input Bypass Capacitor

An input capacitor is recommended. A 10uF tantalum on the input is a suitable input bypassing for almost all applications.

2. Output Capacitor

The output capacitor is critical in maintaining regulator stability, and must meet the required conditions for both minimum amount of capacitance and ESR (Equivalent Series Resistance). The minimum output capacitance required by the ME6118 is 10μF, if a tantalum capacitor is used. Any increase of the output capacitance will merely improve the loop stability and transient response. The ESR of the output capacitor should be less than 0.5Ω.

3. Load Regulation

The ME6118 regulates the voltage that appears between its output and ground pins, or between its output and adjust pins. In some cases, line resistances can introduce errors to the voltage across the load. To obtain the best load regulation, a few precautions are needed. Figure 1, shows a typical application using a fixed output regulator. The R_{t1} and R_{t2} are the line resistances. It is obvious that the V_{LOAD} is less than the V_{OUT} by the sum of the voltage drops along the line resistances. In this case, the load regulation seen at the R_{LOAD} would be degraded from the datasheet specification. To improve this, the load should be tied directly to the output terminal on the positive side and directly tied to the ground terminal on the negative side.

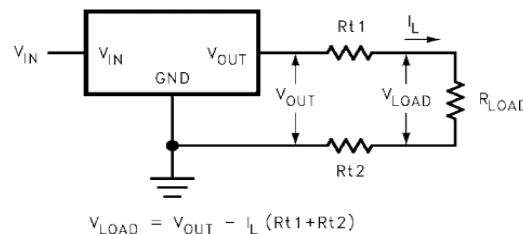

FIGURE 1. Typical Application using Fixed Output Regulator



Application Circuit

ME6118

(1) Regulator with Reference

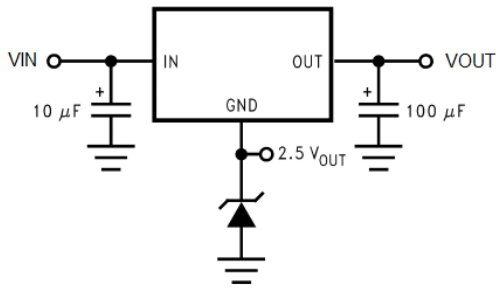

(2) Adjusting Output of Fixed Voltage Regulators

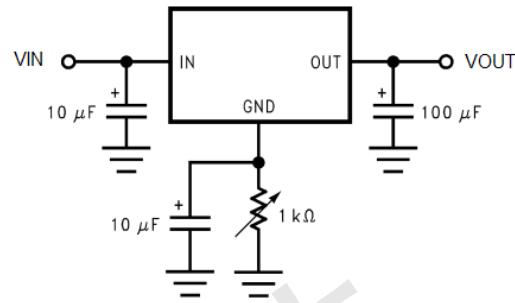

(3) Battery Backed-Up Power Supply

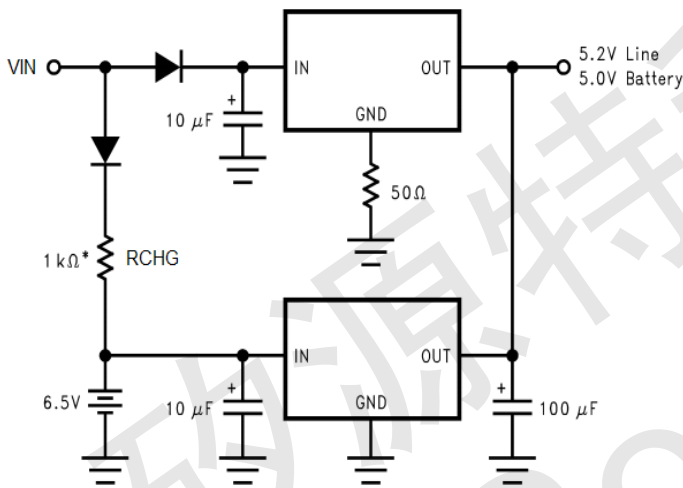

* Select for charge rate.

(4) Low Dropout Negative Supply

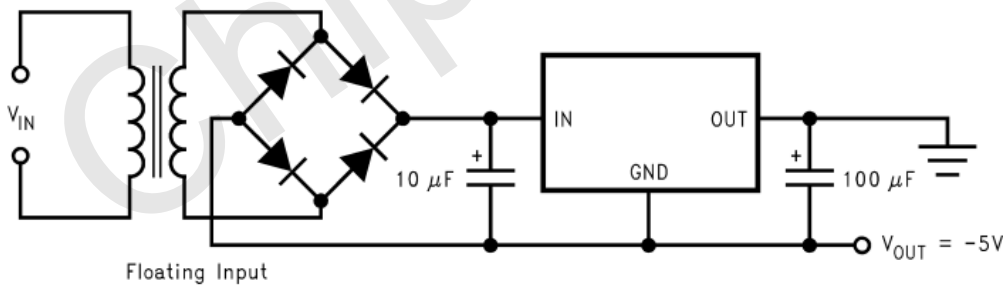



Packaging Information

ME6118

- SOT223

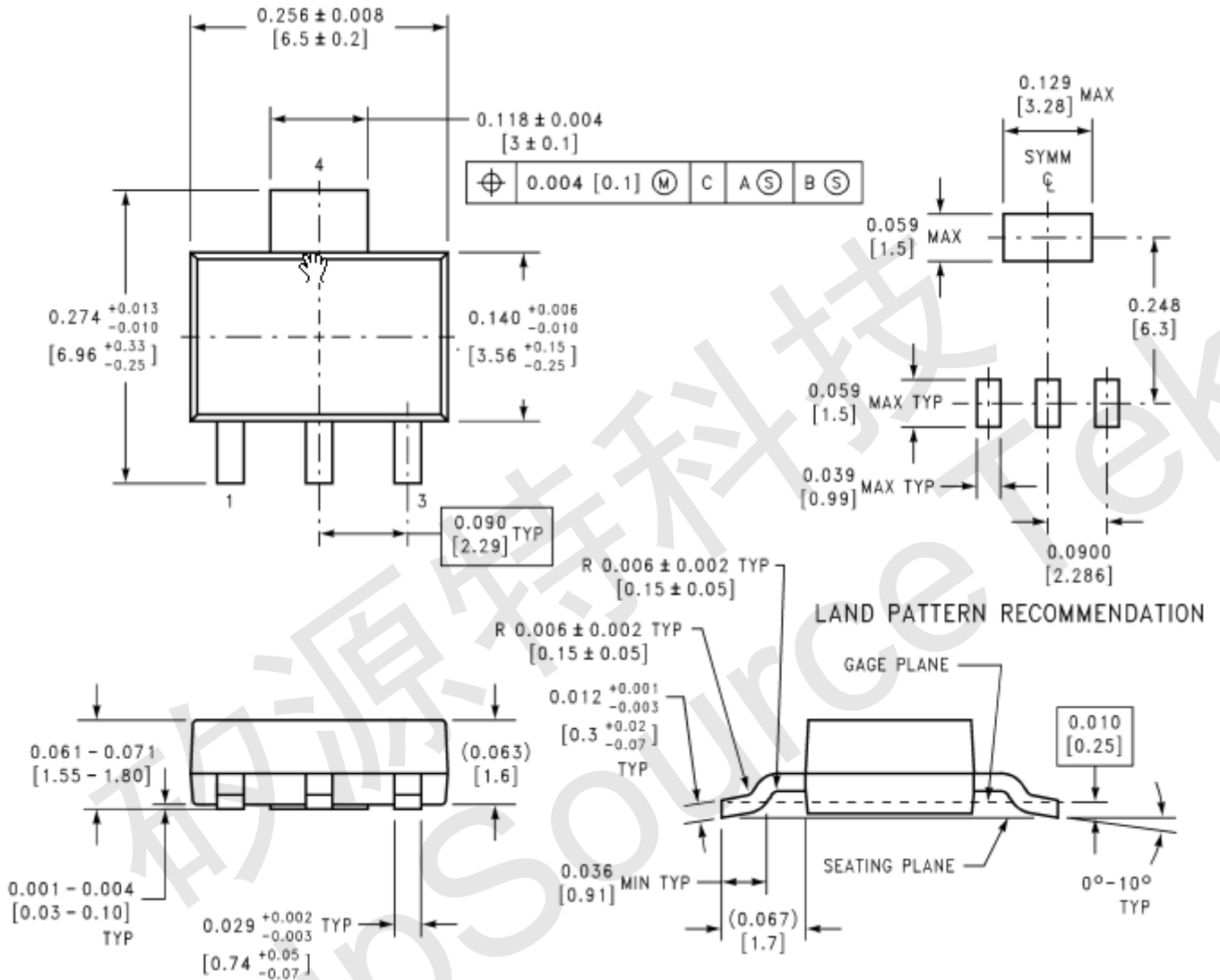



● SOT23-3

ME6118

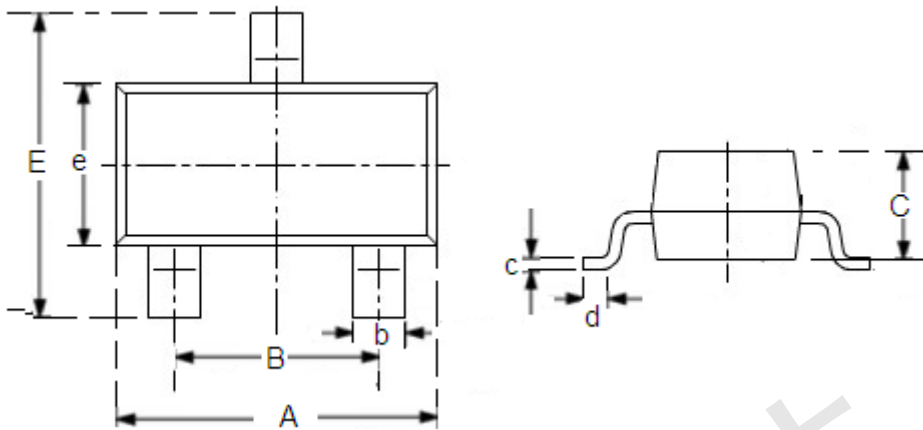

DIM	Millimeters		Inches	
	Min	Max	Min	Max
A	2.7	3.1	0.1063	0.122
B	1.7	2.1	0.0669	0.0827
b	0.35	0.5	0.0138	0.0197
C	1.0	1.2	0.0394	0.0472
c	0.1	0.25	0.0039	0.0098
d	0.2	-	0.0079	-
E	2.6	3.0	0.1023	0.1181
e	1.5	1.8	0.059	0.0708



深圳市矽源特科技有限公司
ShenZhen ChipSourceTek Technology Co. ,Ltd.



ME6118

矽源特科技
ChipSourceTek