

High Input Voltage, Low Dropout, Low Supply Current ME6201 Series

General Description

ME6201 series are low-dropout linear voltage regulators with a built-in voltage reference module, error correction module and phase compensation module. ME6201 series are based on the CMOS process and allow high voltage input with low quiescent current. This series has the function of internal feedback resistor setting from 3V to 5V. The output accuracy is $\pm 2.5\%$.

Features

- | High output accuracy: $\pm 2.5\%$
- | Input voltage: up to 16V
- | Output voltage: 3.0 V ~ 5.0V
- | Ultra-low Supply current (Typ. = 4 μ A)
- | Iout = 100mA (When Vin = 5.3V and Vout = 3.3V)
- | Importation good stability: Typ. 0.1% / V
- | Low temperature coefficient
- | Ceramic capacitor can be used
- | Package: SOT-89, TO-92, SOT23-3

Selection Guide

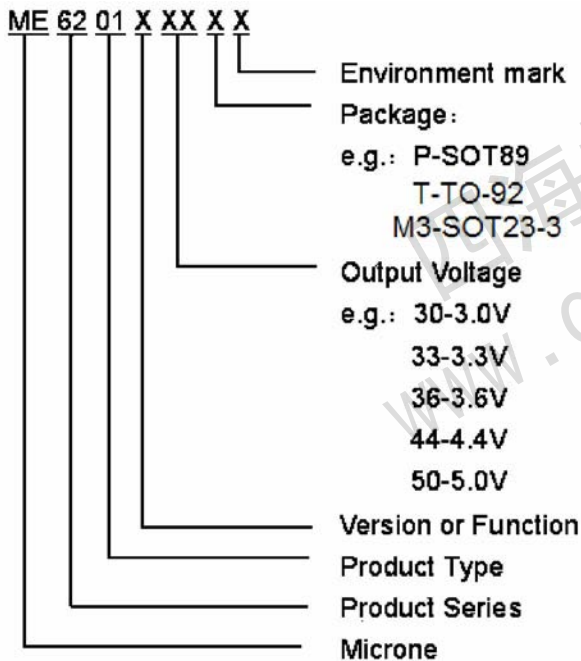

Typical Application

- | Electronic weighbridge
- | SCM
- | Phones, cordless phones
- | Security Products
- | Water meters, power meters

Typical Application Circuit

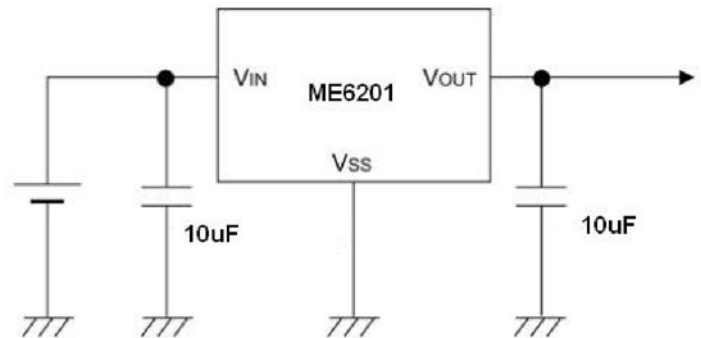

Caution: The above connection diagram and constant will not guarantee successful operation. Perform thorough evaluation using the actual application to set the constant. Input capacitor (CIN): 10.0 μ F or more ; Output capacitor (CL): 10 μ F or more (tantalum capacitor)

Pin Configuration

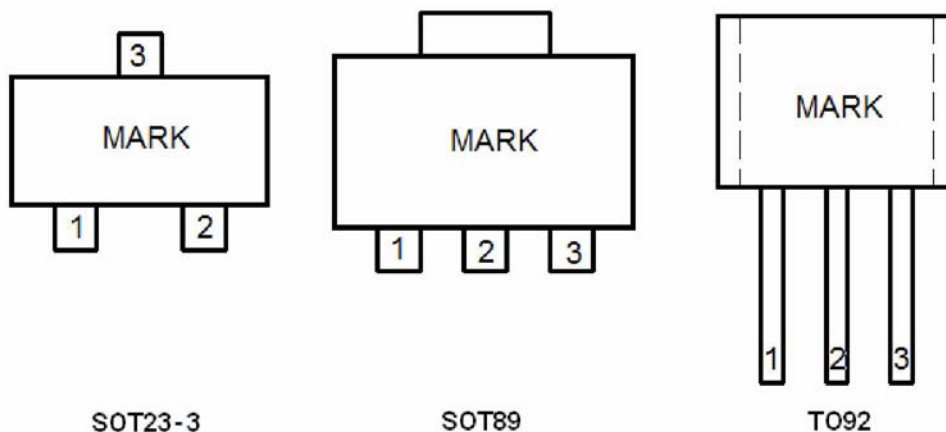

Pin Assignment

ME6201AXX

PIN Number			PIN NAME	FUNCTION
SOT23-3	SOT89-3	TO-92		
1	1	1	VSS	Ground
3	2	2	VIN	Input
2	3	3	VOUT	Output

Absolute Maximum Ratings

PARAMETER	SYMBOL	RATINGS	UNITS
Input Voltage	V_{IN}	18	V
Output Current	I_{out}	200	mA
Output Voltage	V_{out}	$V_{ss}-0.3 \sim V_{out}+0.3$	V
Power Dissipation	SOT-89	P_d	500 mW
	TO-92	P_d	500 mW
Operating Ambient Temperature	T_{OPR}	-25 ~ +85	
Storage Temperature	T_{STG}	-40 ~ +125	
Soldering Temperature And Time	T_{SOLDER}	260 , 10s	

Caution: The absolute maximum ratings are rated values exceeding which the product could suffer physical damage. These values must therefore not be exceeded under any conditions.

Block Diagram

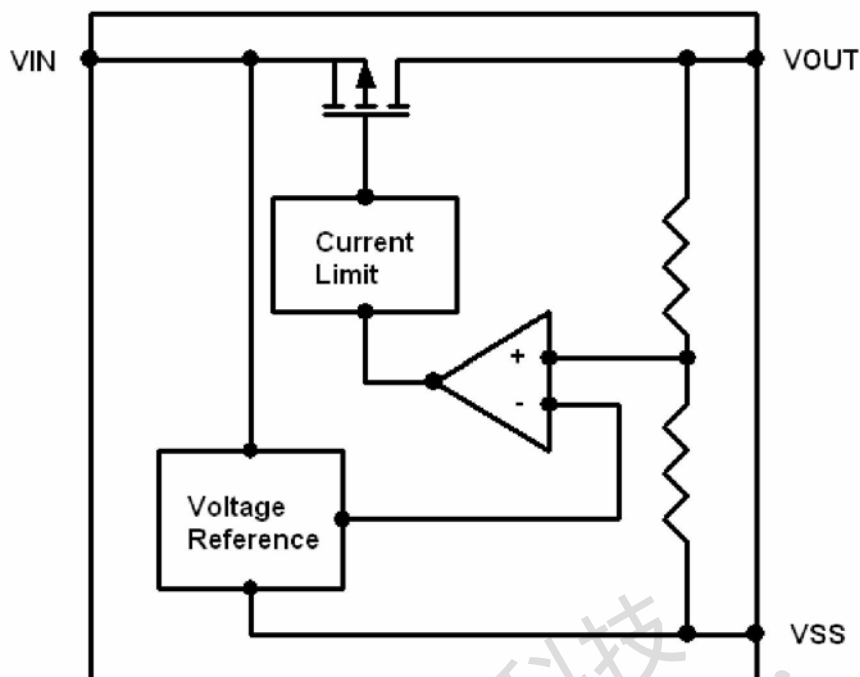

Electrical Characteristics

ME6201A30 ($V_{IN}=V_{OUT}+2V, C_{IN}=C_{OUT}=10\mu F, T_a=25^{\circ}C$ Unless otherwise stated)

PARAMETER	SYMBOL	CONDITION	MIN	TYP	MAX	UNITS
Output Voltage	$V_{OUT(E)}$ (Note 2)	$I_{OUT}=10mA,$ $V_{IN}=V_{out}+2V$	X 0.975	$V_{OUT(T)}$	X 1.025	V
Input Voltage	V_{IN}		3.0		16	V
Maximum Output Current	$I_{OUT(max)}$	$V_{IN}=V_{out}+2V$		100(Note4)		mA
Load Regulation	V_{OUT}	$V_{IN}=V_{out}+2V,$ $1mA \leq I_{OUT} \leq 80mA$		40		mV
Dropout Voltage (Note 3)	V_{DIF1}	$I_{OUT} = 10mA$		170		mV
	V_{DIF2}	$I_{OUT} = 50mA$		800		mV
Supply Current	I_{SS}	$V_{IN}=V_{out}+2V$		4	8	μA
Line Regulations	$\frac{V_{OUT}}{V_{IN} \cdot V_{OUT}}$	$I_{OUT} = 30mA$ $V_{out}+2V \leq V_{IN} \leq 16V$		0.1		%/V

ME6201A33 (VIN=VOUT+2V,CIN=COUT=10uF,Ta=25°C Unless otherwise stated)

PARAMETER	SYMBOL	CONDITION	MIN	TYP	MAX	UNITS
Output Voltage	V _{OUT} (E) (Note 2)	I _{OUT} =10mA, V _{IN} =Vout+2V	X 0.975	V _{OUT} (T)	X 1.025	V
Input Voltage	V _{IN}		3.3		16	V
Maximum Output Current	I _{OUT} (max)	V _{IN} =Vout+2V		100(Note4)		mA
Load Regulation	V _{OUT}	V _{IN} =Vout+2V, 1mA I _{OUT} 80mA		40		mV
Dropout Voltage (Note 3)	V _{dif1}	I _{OUT} =10mA		150		mV
	V _{dif2}	I _{OUT} =50mA		700		mV
Supply Current	I _{SS}	V _{IN} =Vout+2V		4	8	μA
Line Regulations	$\frac{V_{OUT}}{V_{IN} \cdot V_{OUT}}$	I _{OUT} =30mA Vout+2V V _{IN} 16V		0.1		%/V

ME6201A36 (VIN=VOUT+2V,CIN=COUT=10uF,Ta=25°C Unless otherwise stated)

PARAMETER	SYMBOL	CONDITION	MIN	TYP	MAX	UNITS
Output Voltage	V _{OUT} (E) (Note 2)	I _{OUT} =10mA, V _{IN} =Vout+2V	X 0.975	V _{OUT} (T)	X 1.025	V
Input Voltage	V _{IN}		3.6		16	V
Maximum Output Current	I _{OUT} (max)	V _{IN} =Vout+2V		100(Note4)		mA
Load Regulation	V _{OUT}	V _{IN} =Vout+2V, 1mA I _{OUT} 80mA		40		mV
Dropout Voltage (Note 3)	V _{dif1}	I _{OUT} =10mA		150		mV
	V _{dif2}	I _{OUT} =50mA		700		mV
Supply Current	I _{SS}	V _{IN} =Vout+2V		4	8	μA
Line Regulations	$\frac{V_{OUT}}{V_{IN} \cdot V_{OUT}}$	I _{OUT} =30mA Vout+2V V _{IN} 16V		0.1		%/V

ME6201A44 (VIN=VOUT+2V,CIN=COUT=10uF,Ta=25°C Unless otherwise stated)

PARAMETER	SYMBOL	CONDITION	MIN	TYP	MAX	UNITS
Output Voltage	V _{OUT} (E) (Note 2)	I _{OUT} =10mA, V _{IN} =Vout+2V	X 0.975	V _{OUT} (T)	X 1.025	V
Input Voltage	V _{IN}		4.4		16	V
Maximum Output Current	I _{OUT} (max)	V _{IN} =Vout+2V		100(Note4)		mA

Load Regulation	V_{OUT}	$V_{IN}=V_{out}+2V,$ $1mA I_{OUT} 80mA$		40		mV
Dropout Voltage (Note 3)	V_{dif1}	$I_{OUT} =10mA$		120		mV
	V_{dif2}	$I_{OUT} =50mA$		600		mV
Supply Current	I_{SS}	$V_{IN}=V_{out}+2V$		4	8	μA
Line Regulations	$\frac{V_{OUT}}{V_{IN} \cdot V_{OUT}}$	$I_{OUT} =30mA$ $V_{out}+2V V_{IN} 16V$		0.1		%/V

ME6201A50 ($V_{IN}=V_{OUT}+2V, C_{IN}=C_{OUT}=10\mu F, T_a=25^{\circ}C$ Unless otherwise stated)

PARAMETER	SYMBOL	CONDITION	MIN	TYP	MAX	UNITS
Output Voltage	$V_{OUT}(E)$ (Note 2)	$I_{OUT}=10mA,$ $V_{IN}=V_{out}+2V$	X 0.975	$V_{OUT} (T)$	X 1.025	V
Input Voltage	V_{IN}		5		16	V
Maximum Output Current	$I_{OUT} (max)$	$V_{IN}=V_{out}+2V$		100(Note4)		mA
Load Regulation	V_{OUT}	$V_{IN}=V_{out}+2V,$ $1mA I_{OUT} 80mA$		60		mV
Dropout Voltage (Note 3)	V_{dif1}	$I_{OUT} =10mA$		100		mV
	V_{dif2}	$I_{OUT} =50mA$		550		mV
Supply Current	I_{SS}	$V_{IN}=V_{out}+2V$		5	8	μA
Line Regulations	$\frac{V_{OUT}}{V_{IN} \cdot V_{OUT}}$	$I_{OUT} =30mA$ $V_{out}+2V V_{IN} 16V$		0.1		%/V

Note :

- $V_{OUT} (T)$: Specified Output Voltage
- $V_{OUT} (E)$: Effective Output Voltage (i.e. The output voltage when " $V_{OUT} (T)+2.0V$ " is provided at the Vin pin while maintaining a certain Iout value.)
- $V_{DIF} : V_{IN1} - V_{OUT} (E)'$
 V_{IN1} : The input voltage when $V_{OUT}(E)'$ appears as input voltage is gradually decreased. $V_{OUT} (E)'$ =A voltage equal to 98% of the output voltage whenever an amply stabilized Iout { $V_{OUT} (T)+2.0V$ } is input.
- The output current can be at least this value. Due to restrictions on the package power dissipation, this value may not be satisfied. Attention should be paid to the power dissipation of the package when the output current is large. This specification is guaranteed by design.

Application Conditions

Precautions : Wiring patterns for the VIN, VOUT and GND pins should be designed so that the impedance is low. When mounting an output capacitor between the VOUT and VSS pins (CL) and a capacitor for stabilizing the input between VIN and VSS pins (CIN), the distance from the capacitors to these pins should be as short as possible (less than 0.5cm).

Type Characteristics

(1) Output Current VS. Output Voltage ($T_a = 25\text{ }^\circ\text{C}$)

ME6201A30PG

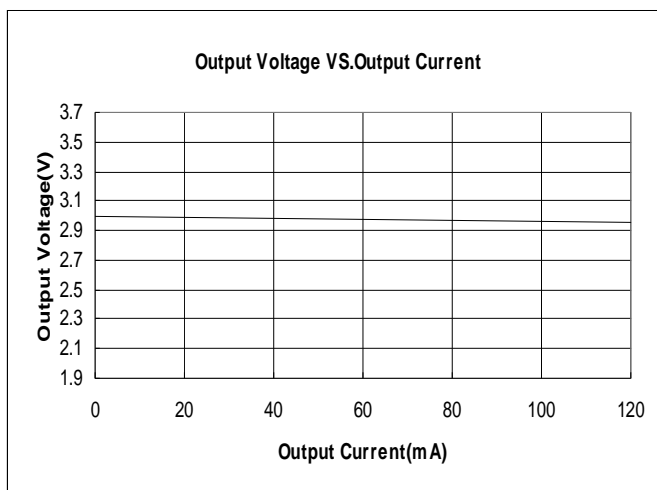

ME6201A33PG

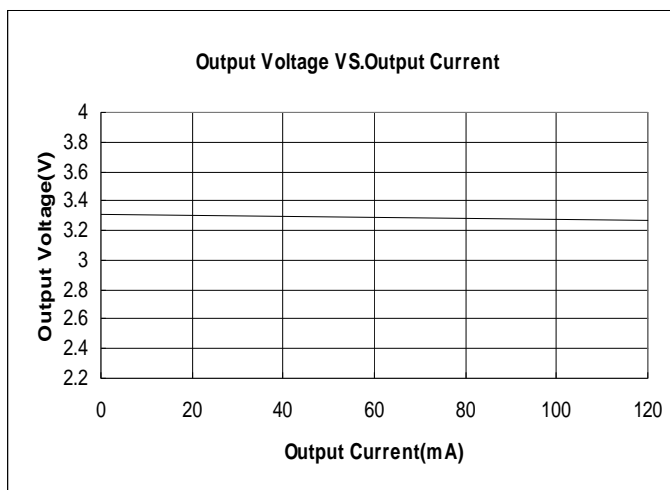

ME6201A36PG

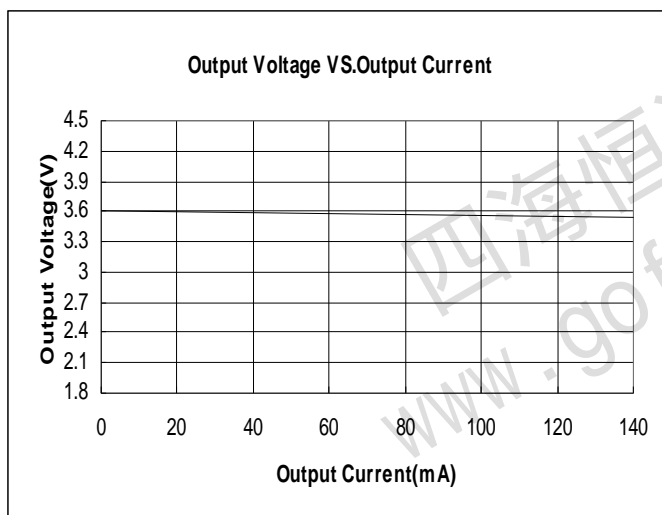

ME6201A44PG

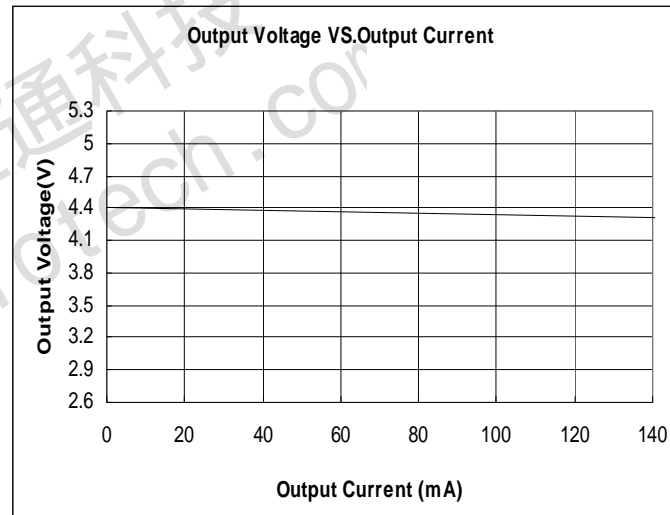

ME6201A50PG

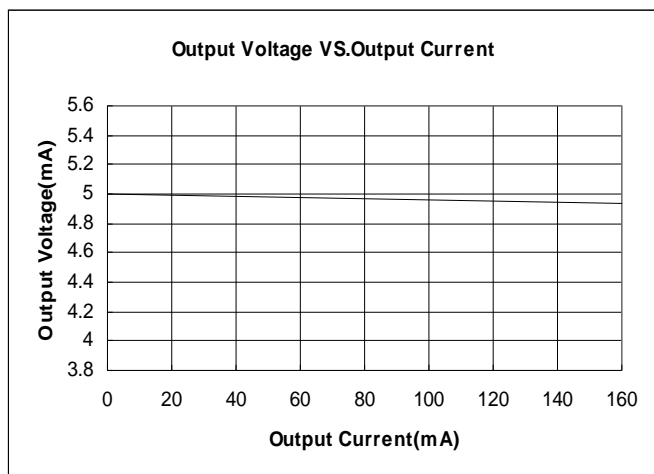

(2) Input Voltage VS. Output Voltage ($T_a = 25^\circ\text{C}$)

ME6201A30PG

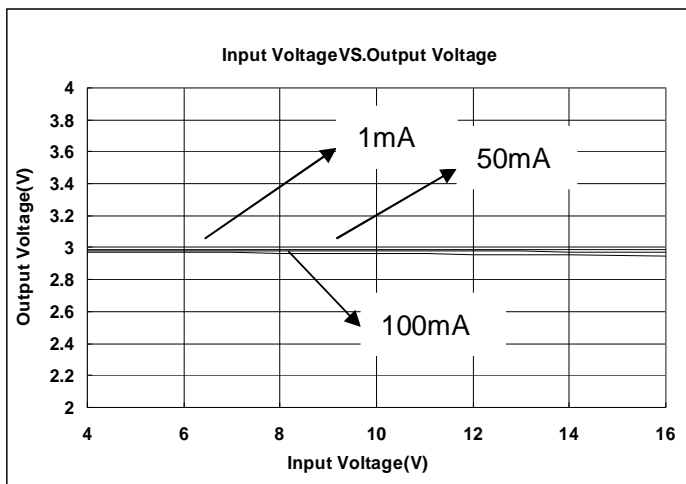

ME6201A33PG

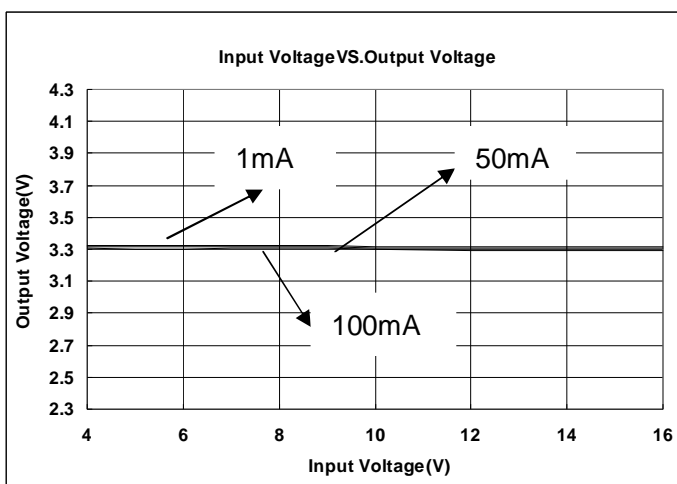

ME6201A36PG

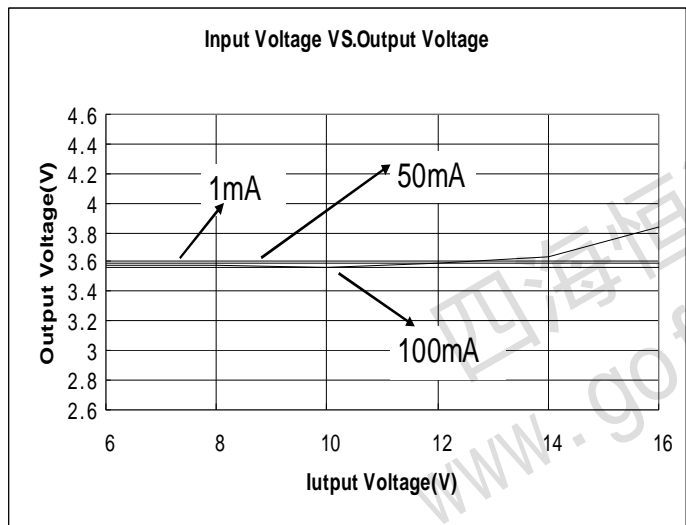

ME6201A44PG

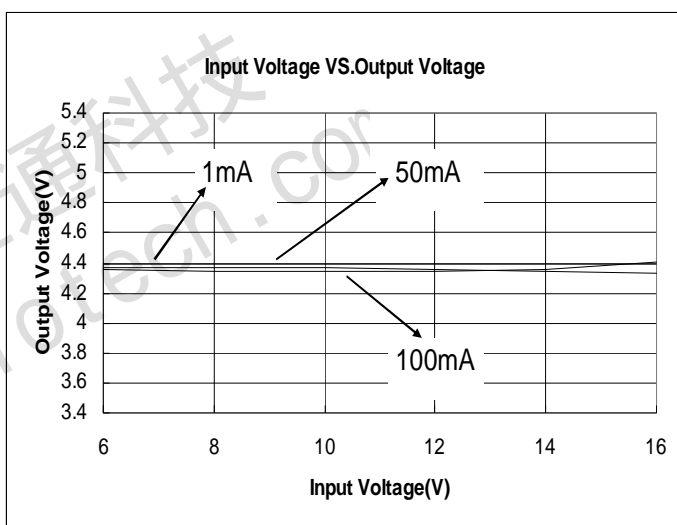

ME6201A50PG

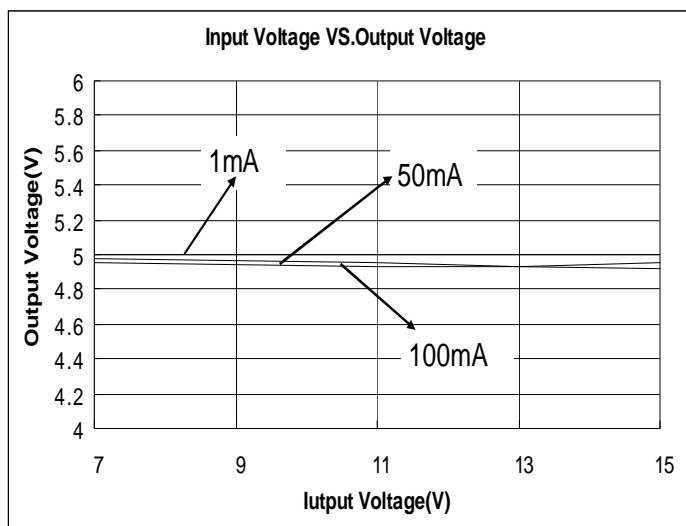

(3) Output Current VS. Dropout Voltage ($T_a = 25^\circ\text{C}$)

ME6201A30PG

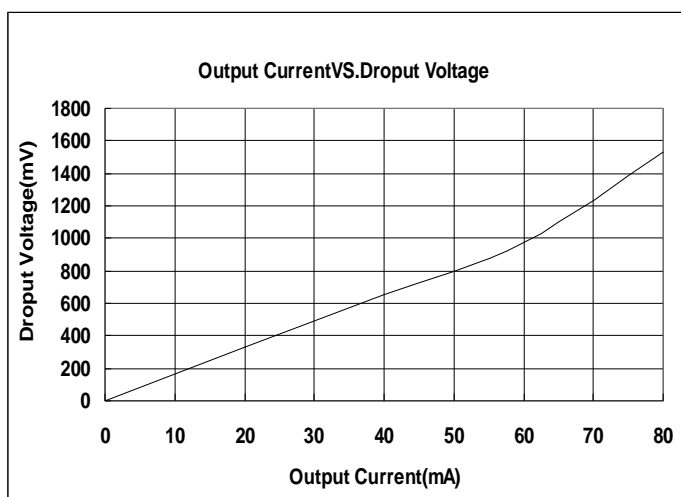

ME6201A33PG

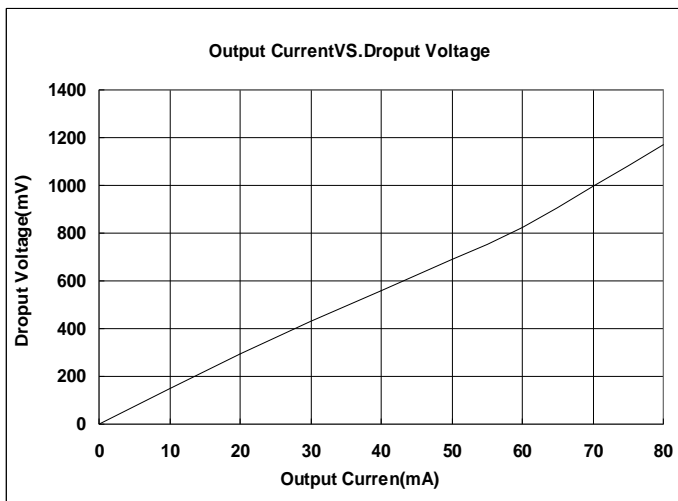

ME6201A36PG

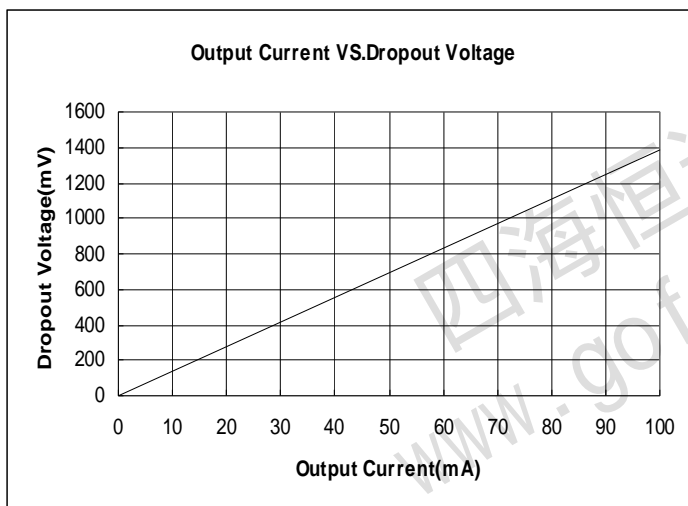

ME6201A44PG

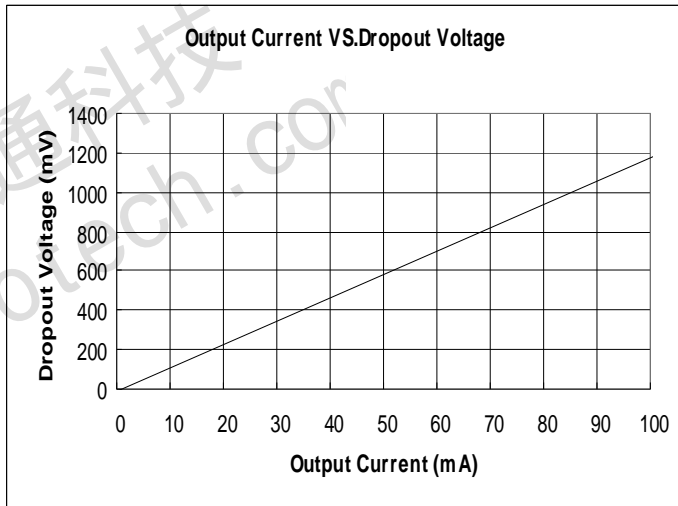

ME6201A50PG

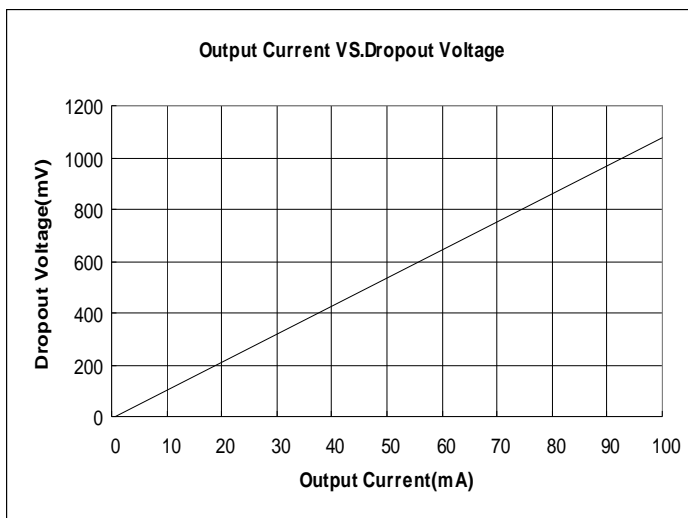

(4) Input Voltage VS. Supply Current (Ta = 25 °C)

ME6201A30PG

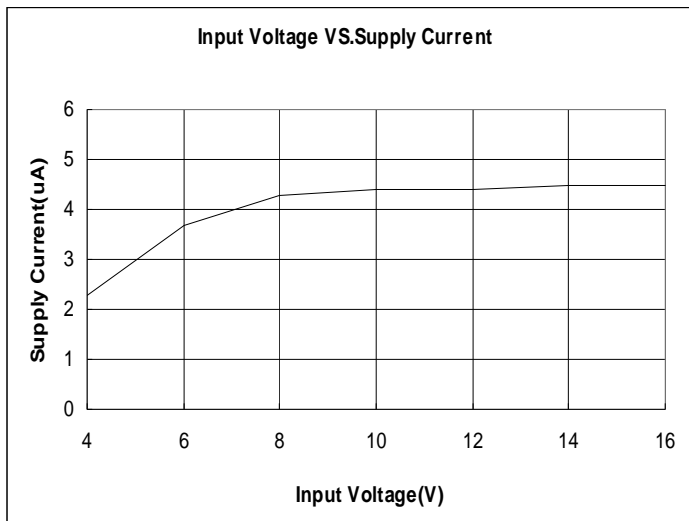

ME6201A33PG

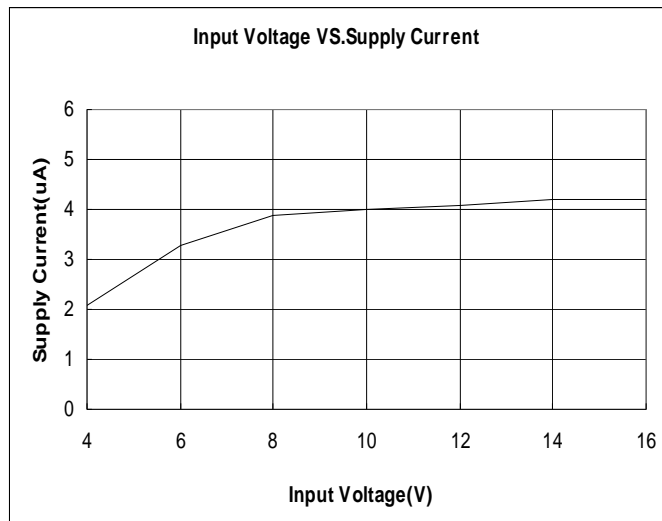

ME6201A36PG

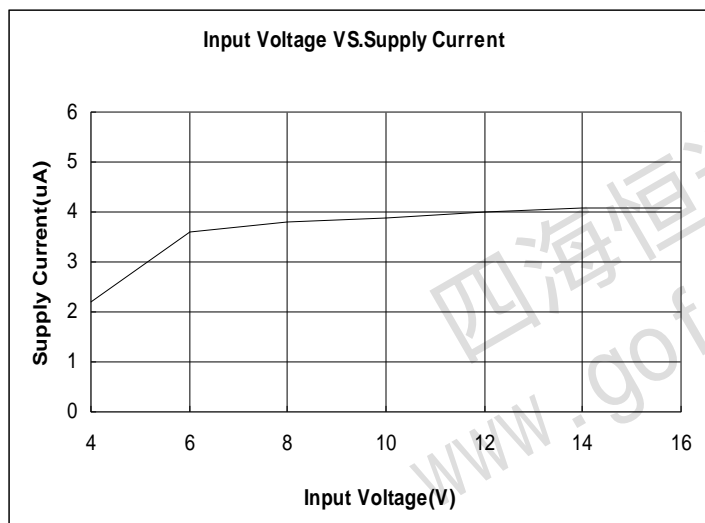

ME6201A44PG

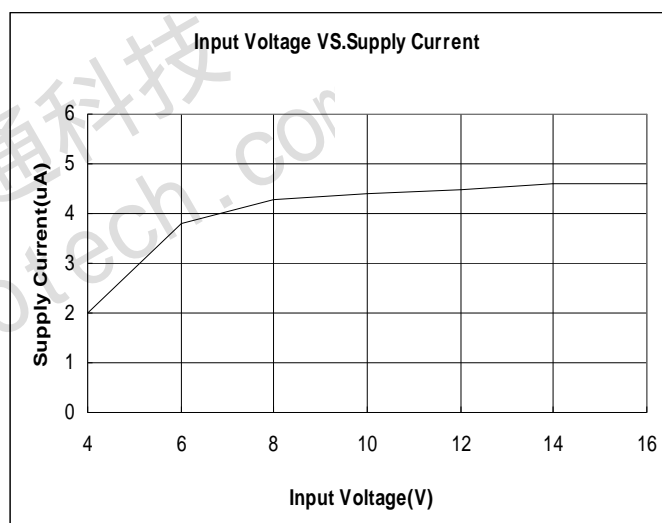

ME6201A50PG

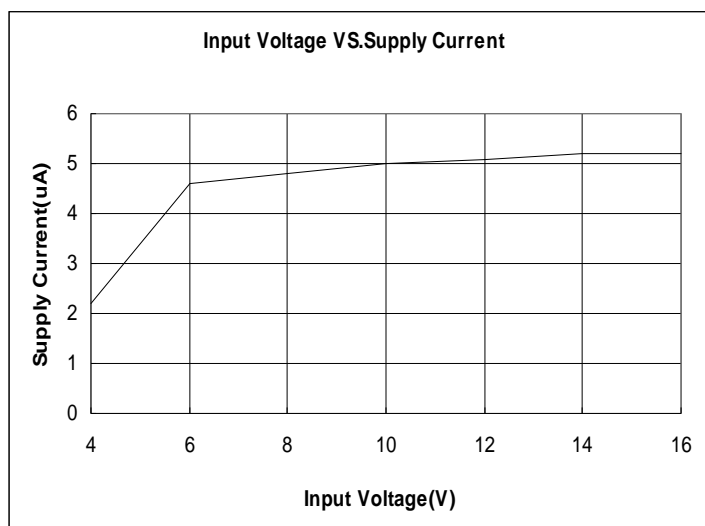

Packaging Information:

SOT89-3

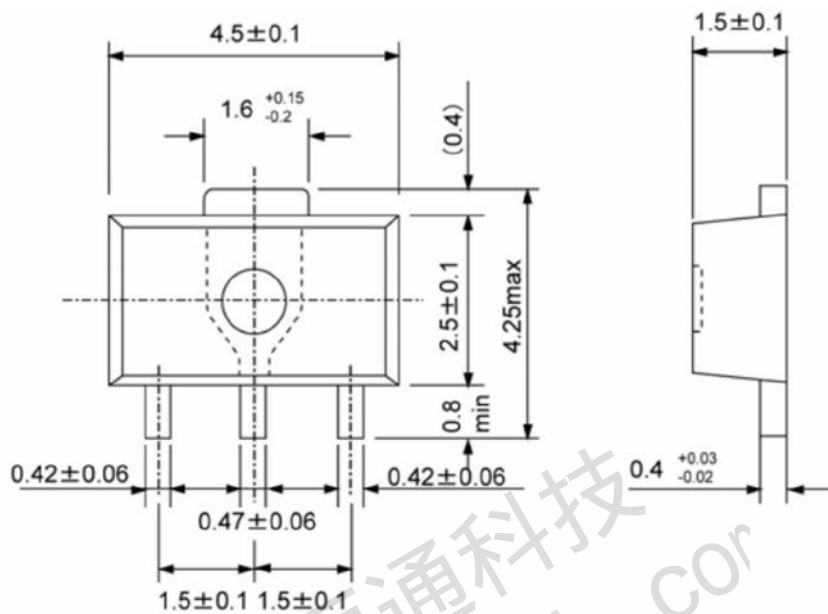

TO-92

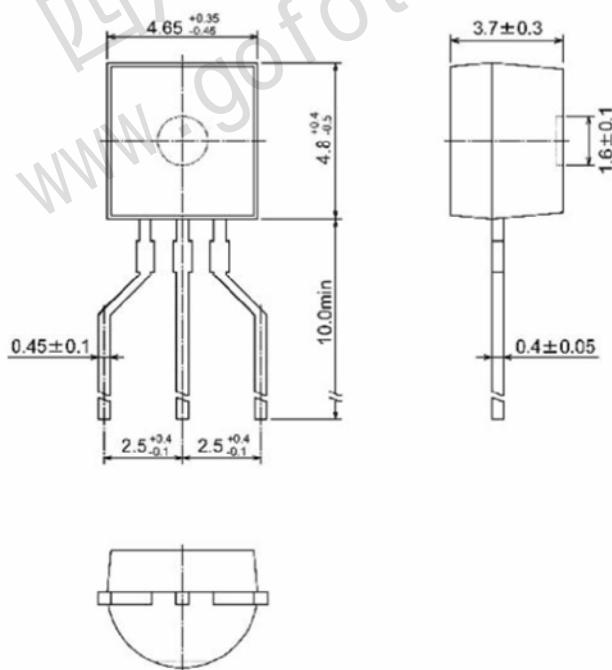

SOT23-3

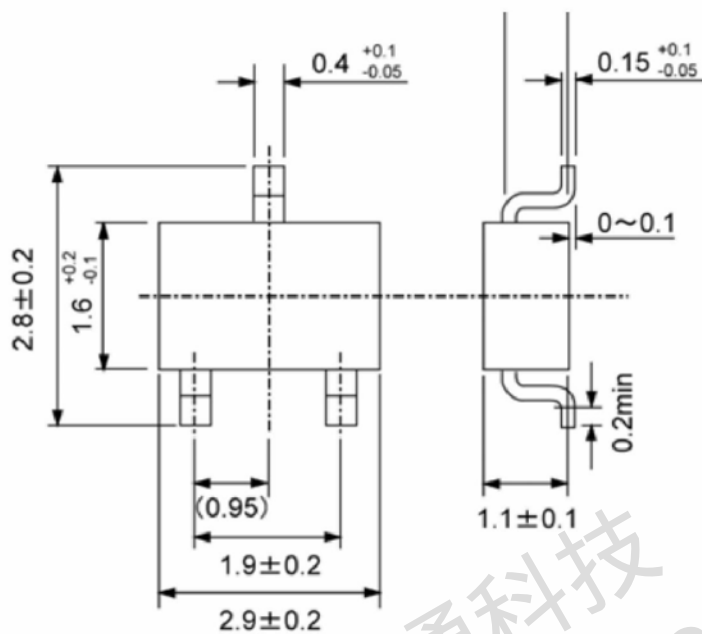

- I The information described herein is subject to change without notice.
- I Nanjing Micro One Electronics Inc is not responsible for any problems caused by circuits or diagrams described herein whose related industrial properties, patents, or other rights belong to third parties. The application circuit examples explain typical applications of the products, and do not guarantee the success of any specific mass-production design.
- I Use of the information described herein for other purposes and/or reproduction or copying without the express permission of Nanjing Micro One Electronics Inc is strictly prohibited.
- I The products described herein cannot be used as part of any device or equipment affecting the human body, such as exercise equipment, medical equipment, security systems, gas equipment, or any apparatus installed in airplanes and other vehicles, without prior written permission of Nanjing Micro One Electronics Inc.
- I Although Nanjing Micro One Electronics Inc exerts the greatest possible effort to ensure high quality and reliability, the failure or malfunction of semiconductor products may occur. The user of these products should therefore give thorough consideration to safety design, including redundancy, fire-prevention measures, and malfunction prevention, to prevent any accidents, fires, or community damage that may ensue.