

**N- Channel 75-V (D-S) MOSFET**

**GENERAL DESCRIPTION**

The ME80N75T is the N-Channel logic enhancement mode power field effect transistors are produced using high cell density, DMOS trench technology. This high density process is especially tailored to minimize on-state resistance.

**PIN CONFIGURATION**

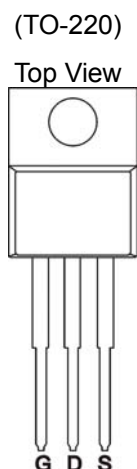

**FEATURES**

- $R_{DS(ON)} \leq 10m\Omega @ V_{GS}=10V$
- Super high density cell design for extremely low  $R_{DS(ON)}$
- Exceptional on-resistance and maximum DC current capability

**APPLICATIONS**

- Power Management
- DC/DC Converter
- Load Switch

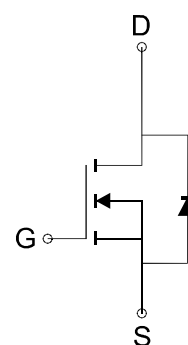

N-Channel MOSFET

Ordering Information: ME80N75T (Pb-free)  
ME80N75T-G (Green product-Halogen free)

**Absolute Maximum Ratings (Tc=25°C Unless Otherwise Noted)**

Parameter		Symbol	Limit	Unit
Drain-Source Voltage		$V_{DSS}$	75	V
Gate-Source Voltage		$V_{GSS}$	±25	V
Continuous Drain Current*	Tc=25°C	$I_D$	93	A
	Tc=70°C		78	
Pulsed Drain Current		$I_{DM}$	372	A
Maximum Power Dissipation	Tc=25°C	$P_D$	200	W
	Tc=70°C		140	
Operating Junction and Storage Temperature Range		$T_J$	-55 to 175	°C
Thermal Resistance-Junction to Case**		$R_{\theta JC}$	0.75	°C/W

\* Calculated continuous current based on maximum allowable junction temperature. Package limitation current is 80A.

\*\* The device mounted on 1in<sup>2</sup> FR4 board with 2 oz copper.



## N- Channel 75-V (D-S) MOSFET

### Electrical Characteristics (TA=25°C Unless Otherwise Specified)

Symbol	Parameter	Limit	Min	Typ	Max	Unit
<b>STATIC</b>						
BV <sub>DSS</sub>	Drain-Source Breakdown Voltage	V <sub>GS</sub> =0V, I <sub>D</sub> =250 μA	75			V
V <sub>GS(th)</sub>	Gate Threshold Voltage	V <sub>DS</sub> =V <sub>GS</sub> , I <sub>D</sub> =250 μA	2.0		4.0	V
I <sub>GSS</sub>	Gate-Body Leakage	V <sub>DS</sub> =0V, V <sub>GS</sub> =±25V			±100	nA
I <sub>DSS</sub>	Zero Gate Voltage Drain Current	V <sub>DS</sub> =75V, V <sub>GS</sub> =0V			1	μA
R <sub>DS(ON)</sub>	Drain-Source On-Resistance*	V <sub>GS</sub> =10V, I <sub>D</sub> =40A		8	10	mΩ
V <sub>SD</sub>	Diode Forward Voltage *	I <sub>S</sub> =40A, V <sub>GS</sub> =0V		0.9	1.2	V
<b>DYNAMIC</b>						
Q <sub>g</sub>	Total Gate Charge	V <sub>DD</sub> =60V, V <sub>GS</sub> =10V, I <sub>D</sub> =75A		134		nC
Q <sub>g</sub>	Total Gate Charge	V <sub>DD</sub> =60V, V <sub>GS</sub> =4.5V, I <sub>D</sub> =75A		27		
Q <sub>gs</sub>	Gate-Source Charge			36		
Q <sub>gd</sub>	Gate-Drain Charge			50		
R <sub>g</sub>	Gate Resistance	V <sub>DS</sub> =0V, V <sub>GS</sub> =0V, f=1MHz		0.8		Ω
C <sub>iss</sub>	Input Capacitance	V <sub>DS</sub> =20V, V <sub>GS</sub> =0V, f=1MHz		6200		pF
C <sub>oss</sub>	Output Capacitance			437		
C <sub>rss</sub>	Reverse Transfer Capacitance			144		
t <sub>d(on)</sub>	Turn-On Delay Time	V <sub>GS</sub> =10V, R <sub>L</sub> =15Ω V <sub>DD</sub> =30V, R <sub>G</sub> =10Ω		60		ns
t <sub>r</sub>	Turn-On Rise Time			43		
t <sub>d(off)</sub>	Turn-Off Delay Time			159		
t <sub>f</sub>	Turn-Off Fall Time			47		

Notes: a. pulse test: pulse width ≤ 300us, duty cycle ≤ 2%, Guaranteed by design, not subject to production testing.

b. Matsuki Electric/ Force mos reserves the right to improve product design, functions and reliability without notice.



**N- Channel 75-V (D-S) MOSFET**

**Typical Characteristics (T<sub>J</sub> =25°C Noted)**

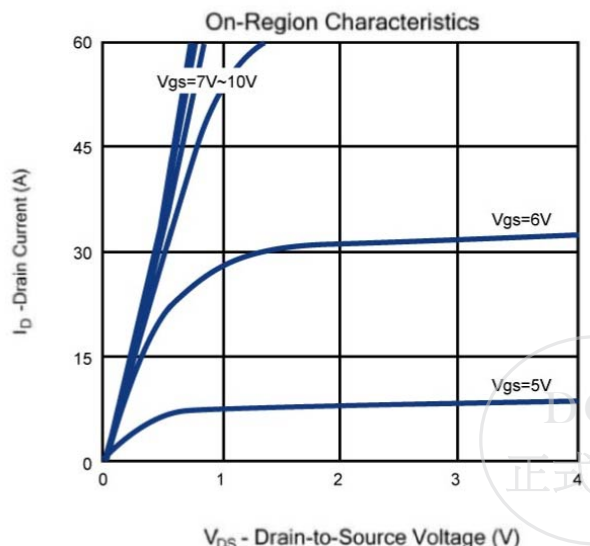
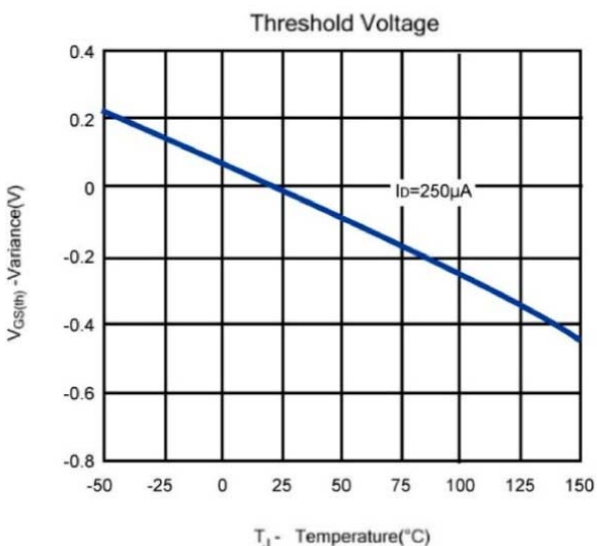
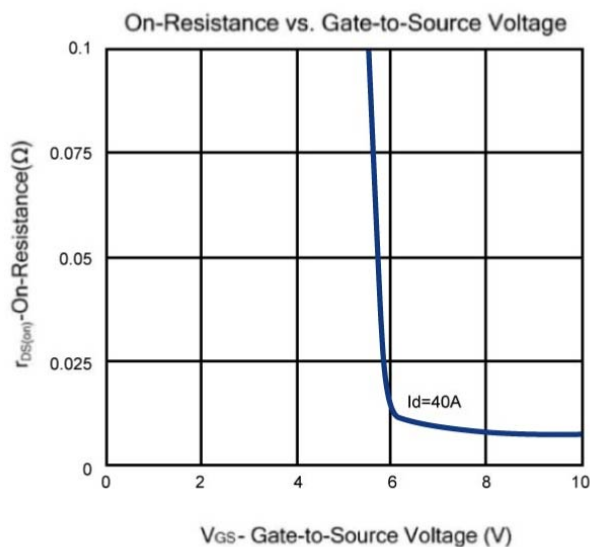
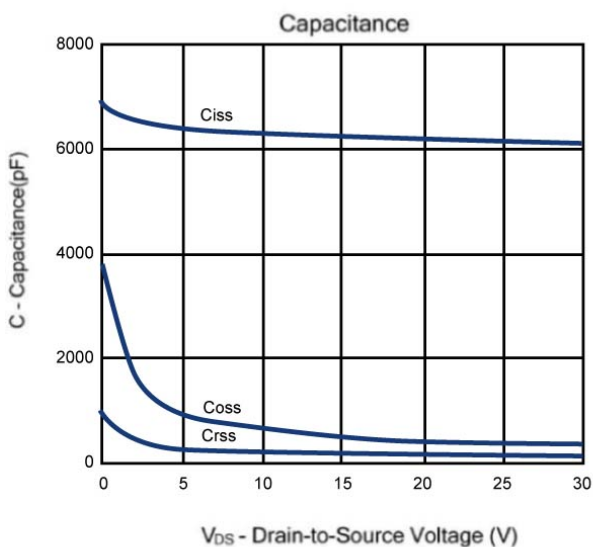
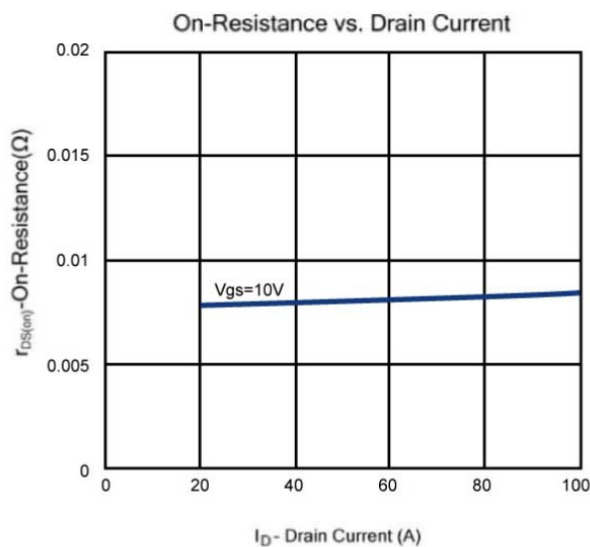
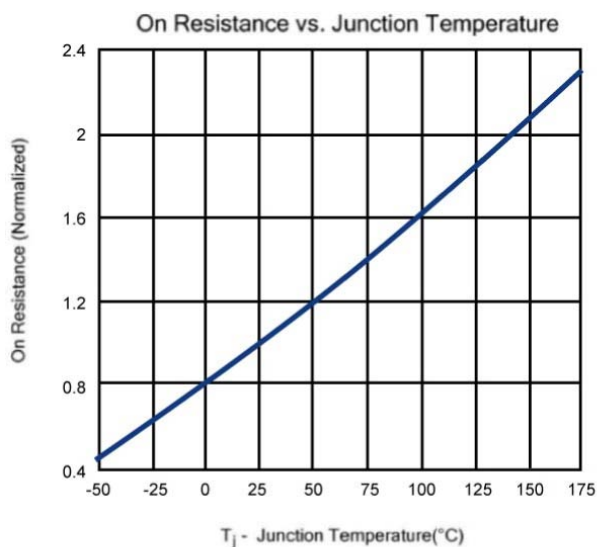

**N- Channel 75-V (D-S) MOSFET**

**Typical Characteristics (T<sub>J</sub> =25°C Noted)**

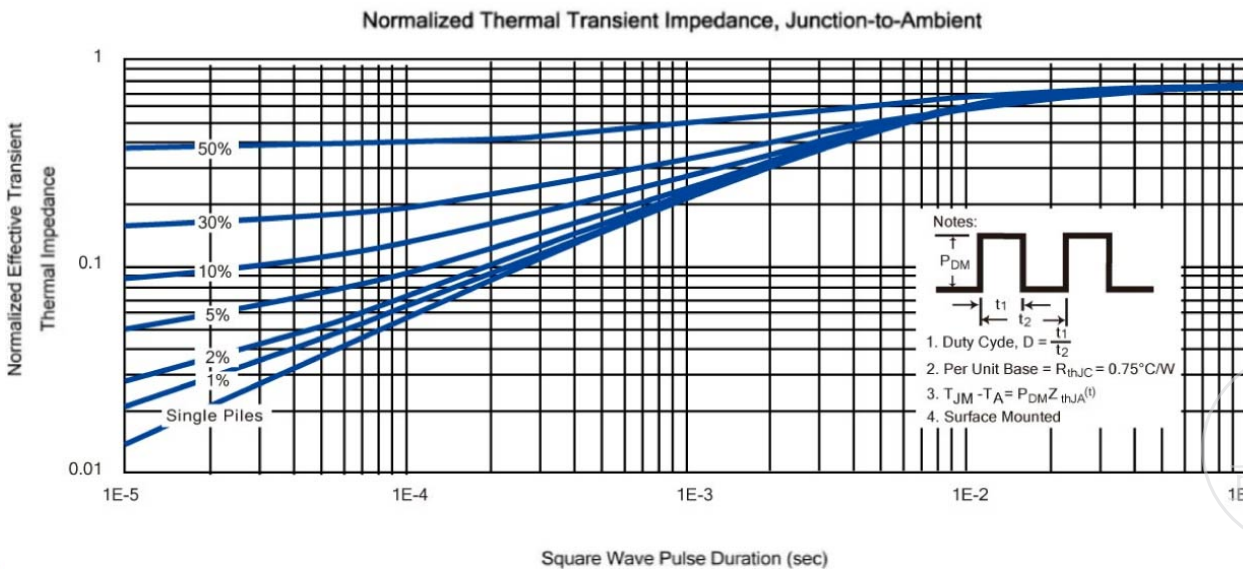
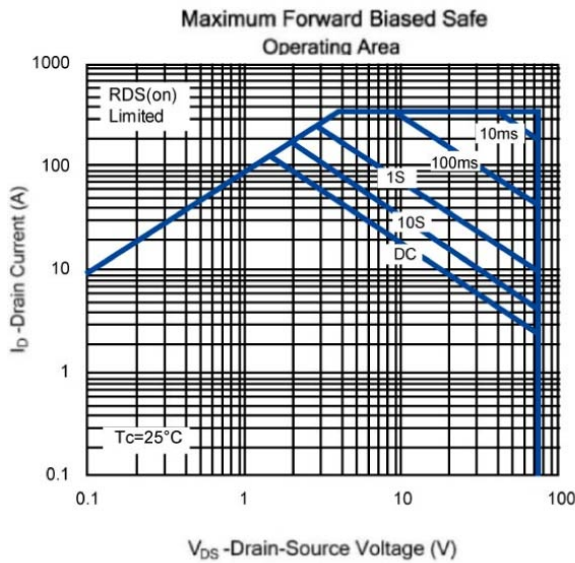
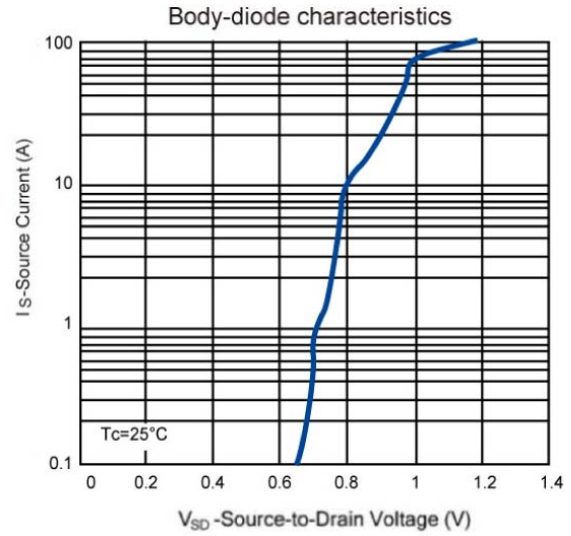
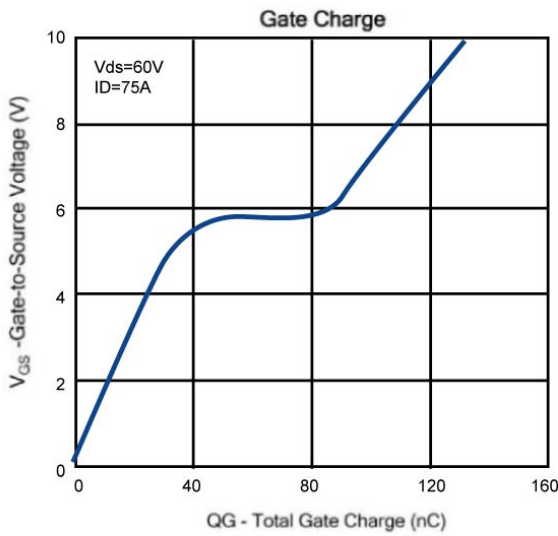

**TO-220 Package Outline**

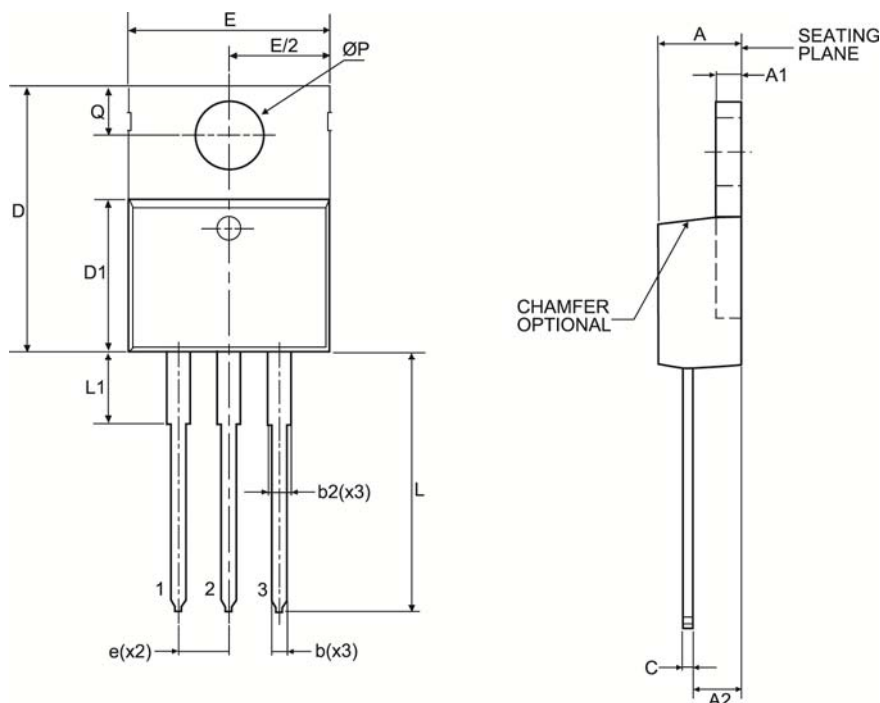

Symbol	MILLIMETERS (mm)	
	MIN	MAX
A	3.50	4.90
A1	1.00	1.40
A2	2.00	3.00
b	0.70	1.40
c	0.35	0.65
D	14.00	16.50
D1	8.30	9.50
E	9.60	10.70
e	2.54 BSC	
L	12.50	15.00
$\varnothing P$	3.60 TYP	
Q	2.50	3.10
b2	1.10	1.80
L1	2.40	3.20

