

MF430 ST



ST Assembly

Ordering Information	
PART #	RECEPTACLE
MF430 ST	ST
-40°C to +85°C	

Applications

- Ethernet 10 or 100Mbps
- Token Ring
- Fibre Channel 266Mbps
- Short Wavelength FDDI
- Short Wavelength ATM-SDH/SONET 155Mbps
- Intra-Office Telecom
- General Purpose

Features

- 865nm Surface-Emitting LED
- 250MHz Bandwidth
- Designed for 62.5/125µm Fiber
- Aligned in ST® Receptacle
- MTTF >1,000,000 hours

Description

This high performance LED has been designed for Datacom, Telecom or General Purpose Applications. The short wavelength LED allows cost-effective links over short distances. This very high speed device has an actively aligned receptacle for optimized coupling of power to 62.5/125µm fiber. A Silicon Photodiode is recommended as Receiver for this LED.

MF430 Functional Diagram

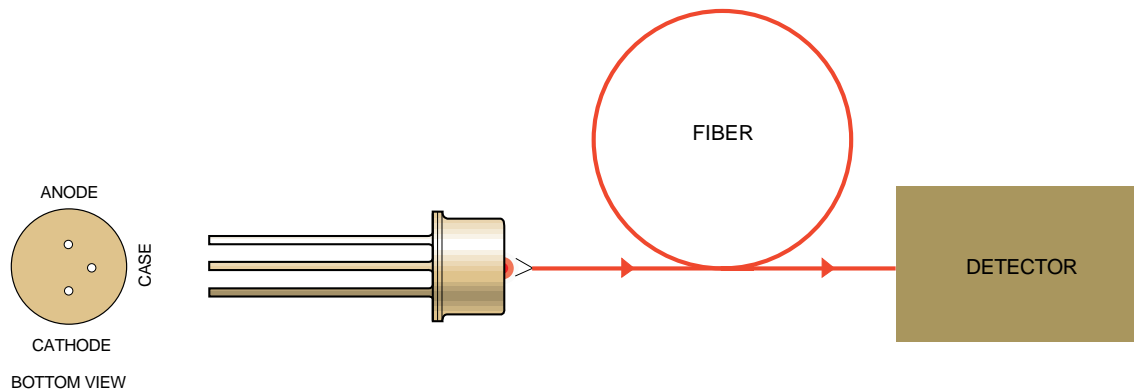

MF430 LED

Absolute Maximum Ratings*

Parameter	Symbol	Min.	Max.	Units
Storage Temperature	T_{stg}	-40	+85	°C
Operating Temperature (Fig 4)	T_{op}	-40	+85	°C
Electrical Power Dissipation (Fig 4)	P_{tot}		250	mW
Continuous Forward Current ($f \leq 10\text{kHz}$)	I_F		110	mA
Peak Forward Current (duty cycle $\leq 50\%$, $f \geq 1\text{MHz}$)	I_{FRM}		180	mA
Reverse Voltage	V_R		1.5	V
Soldering Temperature (Note 1)	T_{sld}		260	°C

*Exceeding these values may cause permanent damage. Functional operation under these conditions is not implied.

Note 1: 2mm from the case for 10s.

Optical & Electrical Characteristics (Case Temperature -25 to +70°C)

Parameter	Symbol	Min.	Typ.	Max.	Units	Test Conditions
Fiber-Coupled-Power (Fig 1, 2, 3)	P_{fiber}	-17.5			dBm	$I_{Peak}=60\text{mA}$ (Note 1,2)
Rise & Fall Time (10-90%, no bias)	t_r, t_f		1.5	2	ns	$I_F=60\text{mA}$ (Note 2)
Bandwidth (3dB _{e1})	f_c		250		MHz	$I_F=60\text{mA}$ (Note 2)
Peak Wavelength	λ_p	850	865	880	nm	$I_F=60\text{mA}$
Spectral Width (FWHM)	$\Delta\lambda$		50	60	nm	$I_F=60\text{mA}$
Forward Voltage (Fig 5)	V_F			2.1	V	$I_F=60\text{mA}$
Reverse Current	I_R			20	μA	$V_R=1\text{V}$
Capacitance	C		20		pF	$V_R=0\text{V}$, $f=1\text{MHz}$

Note 1: Average power at 10MHz/50% duty cycle. Measured at the exit of 100m of fiber.

Note 2: 62.5/125μm graded index fiber (NA = 0.275).

Thermal Characteristics

Parameter	Symbol	Min.	Typ.	Max.	Units
Thermal Resistance - Infinite Heat Sink	R_{thjc}			200	°C/W
Thermal Resistance - On PCB	R_{thjb}			300	°C/W
Temperature Coefficient - Optical Power	dP/dT_j		-0.6		%/°C
Temperature Coefficient - Wavelength	$\Delta\lambda/dT_j$		0.3		nm/°C

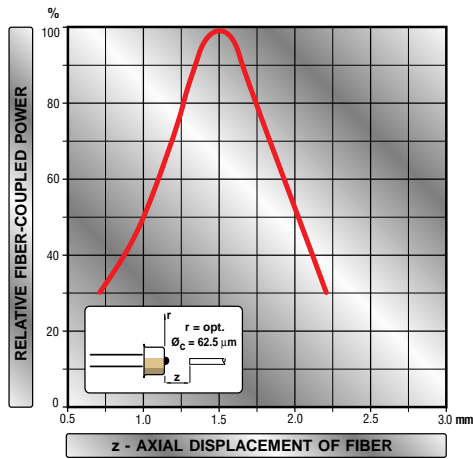

Figure 1

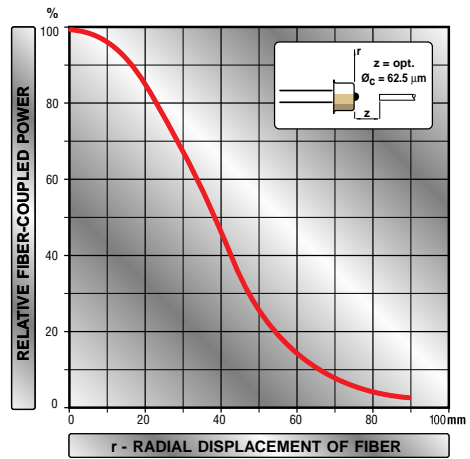

Figure 2

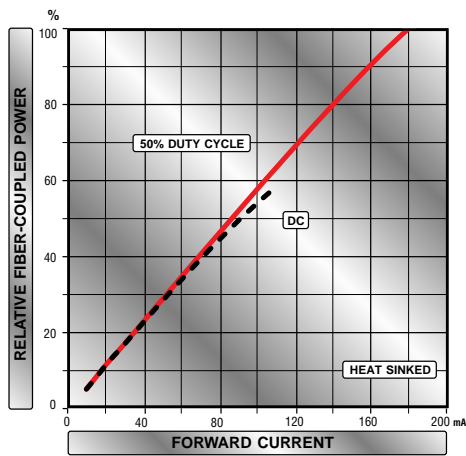

Figure 3

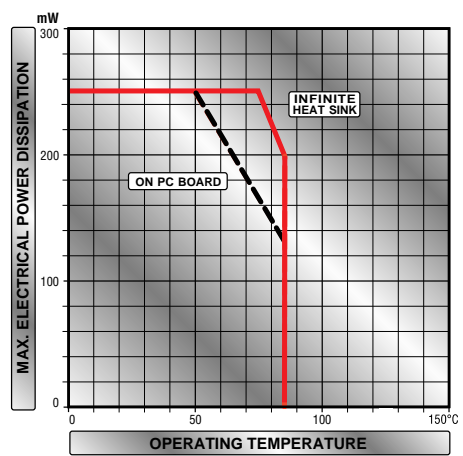

Figure 4

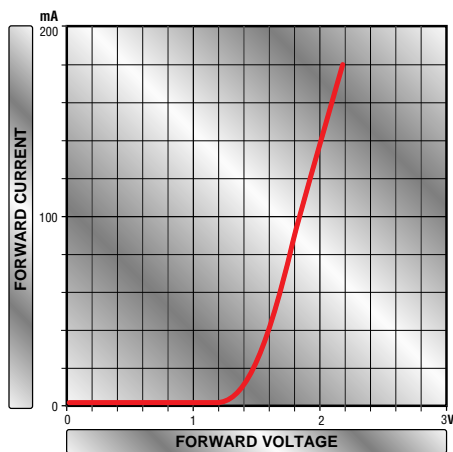
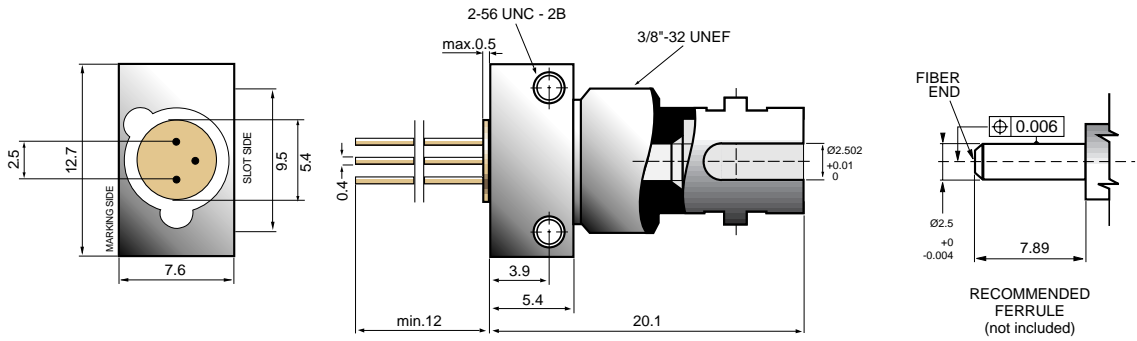

Figure 5

MF430 ST Mechanical Data



Note: The LED chip is isolated from the case. All dimensions in mm.

Typical Drive Circuit

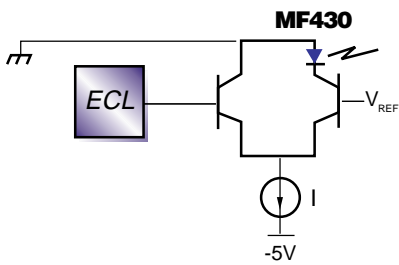

ST Packaging Hardware

