

FEATURES

- Available as "HR" (high reliability) screened per MIL-PRF-19500, JANTX level. Add "HR" suffix to base part number.
- Available as non-RoHS (Sn/Pb plating), standard, and as RoHS by adding "-PBF" suffix.

MAXIMUM RATINGS

Rating	Symbol	Value	Unit
Drain Source Voltage	V_{DS}	25	Vdc
Drain Current	I_D	30	mAdc
Total Power Dissipation @ $T_A = 25^\circ\text{C}$ Derate above 25°C	P_D	300 1.7	mW mW/ $^\circ\text{C}$
Operating and Storage Temperature Range	T_J, T_{stg}	-65 to +175	$^\circ\text{C}$

ELECTRICAL CHARACTERISTICS ($T_A = 25^\circ\text{C}$ unless otherwise noted)

Characteristics	Symbol	Min	Typ	Max	Unit	
OFF CHARACTERISTICS						
Drain Source Breakdown Voltage ($I_D = 100 \mu\text{Adc}$, $V_S = 0$, $V_{G1S} = -4.0 \text{ Vdc}$, $V_{G2S} = 4.0 \text{ V}$)	$V_{(BR)DSX}$	25	-	-	Vdc	
Gate 1 – Source Breakdown Voltage ⁽¹⁾ ($I_{G1} = \pm 10 \mu\text{Adc}$, $V_{G2S} = 0$)	$V_{(BR)G1SO}$	± 7.0	-	± 20	Vdc	
Gate 2 – Source Breakdown Voltage ⁽¹⁾ ($I_{G2} = \pm 10 \mu\text{Adc}$, $V_{G2S} = 0$)	$V_{(BR)G2SO}$	± 7.0	-	± 20	Vdc	
Gate 1 Leakage Current ($V_{G1S} = \pm 6.0 \text{ Vdc}$, $V_{G2S} = 0$, $V_{DS} = 0$)	I_{G1SS}	-	-	20	nAdc	
Gate 2 Leakage Current ($V_{G2S} = \pm 6.0 \text{ Vdc}$, $V_{G1S} = 0$, $V_{DS} = 0$)	I_{G2SS}	-	-	20	nAdc	
Gate 1 to Source Cutoff Voltage ($V_{DS} = 15 \text{ Vdc}$, $V_{G2S} = 4.0 \text{ Vdc}$, $I_D = 200 \mu\text{Adc}$)	$V_{G1S(off)}$	-	-	-4.0	Vdc	
Gate 2 to Source Cutoff Voltage ($V_{DS} = 15 \text{ Vdc}$, $V_{G1S} = 0$, $I_D = 200 \mu\text{Adc}$)	$V_{G2S(off)}$	-	-	-4.0	Vdc	
ON CHARACTERISTICS						
Zero-Gate Voltage Drain Current ($V_{DS} = 15 \text{ Vdc}$, $V_{G1S} = 0$, $V_{G2S} = 4.0 \text{ Vdc}$)	MFE120 MFE121 MFE122	I_{DSS}	2.0 5.0 2.0	7.0 10 9.0	18 30 20	mAdc
SMALL SIGNAL CHARACTERISTICS						
Forward Transfer Admittance (Gate 1 to Drain) ($V_{DS} = 15 \text{ Vdc}$, $V_{G2S} = 4.0 \text{ Vdc}$, $I_D = 10 \text{ mAdc}$, $f = 1.0 \text{ kHz}$)	MFE120, MFE122 MFE121	$ Y_{fs} $	8000 10000	- -	18000 20000	μmhos
Input Capacitance ($V_{DS} = 15 \text{ Vdc}$, $V_{G2S} = 4.0 \text{ Vdc}$, $I_D = I_{DSS}$, $f = 1.0 \text{ MHz}$)	MFE120, MFE122 MFE121	C_{iss}	- -	4.5 4.5	7.0 6.0	pF
Reverse Transfer Capacitance ($V_{DS} = 15 \text{ Vdc}$, $V_{G2S} = 4.0 \text{ Vdc}$, $I_D = 6.0 \text{ mAdc}$, $f = 1.0 \text{ MHz}$)		C_{rss}	-	0.023	-	pF
Output Capacitance ($V_{DS} = 15 \text{ Vdc}$, $V_{G2S} = 4.0 \text{ Vdc}$, $I_D = I_{DSS}$, $f = 1.0 \text{ MHz}$)	MFE120, MFE122 MFE121	C_{oss}	- -	2.5 2.5	4.0 3.5	pF

FUNCTIONAL CHARACTERISTICS						
Noise Figure ($V_{DS} = 15 \text{ Vdc}$, $V_{G2S} = 4.0 \text{ Vdc}$, $I_D = 6.0 \text{ mAdc}$, Z_S is optimized for NF) ($f = 105 \text{ MHz}$, Figure 1) ($f = 60 \text{ MHz}$, figure 3) ($f = 200 \text{ MHz}$, figure 3)	MFE120 MFE121 MFE121	NF	-	2.9	5.0	dB
OFF CHARACTERISTICS						
Drain Source Breakdown Voltage ($I_D = 100 \mu\text{Adc}$, $V_S = 0$, $V_{G1S} = -4.0 \text{ Vdc}$, $V_{G2S} = 4.0 \text{ V}$)		$V_{(BR)DSX}$	25	-	-	Vdc
Gate 1 – Source Breakdown Voltage ⁽¹⁾ ($I_{G1} = \pm 10 \mu\text{Adc}$, $V_{G2S} = 0$)		$V_{(BR)G1SO}$	± 7.0	-	± 20	Vdc
Gate 2 – Source Breakdown Voltage ⁽¹⁾ ($I_{G2} = \pm 10 \mu\text{Adc}$, $V_{G2S} = 0$)		$V_{(BR)G2SO}$	± 7.0	-	± 20	Vdc
Gate 1 Leakage Current ($V_{G1S} = \pm 6.0 \text{ Vdc}$, $V_{G2S} = 0$, $V_{DS} = 0$)		I_{G1SS}	-	-	20	nAdc
Gate 2 Leakage Current ($V_{G2S} = \pm 6.0 \text{ Vdc}$, $V_{G1S} = 0$, $V_{DS} = 0$)		I_{G2SS}	-	-	20	nAdc
Gate 1 to Source Cutoff Voltage ($V_{DS} = 15 \text{ Vdc}$, $V_{G2S} = 4.0 \text{ Vdc}$, $I_D = 200 \mu\text{Adc}$)		$V_{G1S(off)}$	-	-	-4.0	Vdc
Gate 2 to Source Cutoff Voltage ($V_{DS} = 15 \text{ Vdc}$, $V_{G1S} = 0$, $I_D = 200 \mu\text{Adc}$)		$V_{G2S(off)}$	-	-	-4.0	Vdc
ON CHARACTERISTICS						
Zero-Gate Voltage Drain Current ($V_{DS} = 15 \text{ Vdc}$, $V_{G1S} = 0$, $V_{G2S} = 4.0 \text{ Vdc}$)	MFE120 MFE121 MFE122	I_{DSS}	2.0 5.0 2.0	7.0 10 9.0	18 30 20	mAdc
SMALL SIGNAL CHARACTERISTICS						
Forward Transfer Admittance (Gate 1 to Drain) ($V_{DS} = 15 \text{ Vdc}$, $V_{G2S} = 4.0 \text{ Vdc}$, $I_D = 10 \text{ mAdc}$, $f = 1.0 \text{ kHz}$)	MFE120, MFE122 MFE121	$ Y_{fs} $	8000 10000	- -	18000 20000	μmhos
Input Capacitance ($V_{DS} = 15 \text{ Vdc}$, $V_{G2S} = 4.0 \text{ Vdc}$, $I_D = I_{DSS}$, $f = 1.0 \text{ MHz}$)	MFE120, MFE122 MFE121	C_{iss}	- -	4.5 4.5	7.0 6.0	pF
Reverse Transfer Capacitance ($V_{DS} = 15 \text{ Vdc}$, $V_{G2S} = 4.0 \text{ Vdc}$, $I_D = 6.0 \text{ mAdc}$, $f = 1.0 \text{ MHz}$)		C_{rss}	-	0.023	-	pF
Output Capacitance ($V_{DS} = 15 \text{ Vdc}$, $V_{G2S} = 4.0 \text{ Vdc}$, $I_D = I_{DSS}$, $f = 1.0 \text{ MHz}$)	MFE120, MFE122 MFE121	C_{oss}	- -	2.5 2.5	4.0 3.5	pF
FUNCTIONAL CHARACTERISTICS						
Noise Figure ($V_{DS} = 15 \text{ Vdc}$, $V_{G2S} = 4.0 \text{ Vdc}$, $I_D = 6.0 \text{ mAdc}$, Z_S is optimized for NF) ($f = 105 \text{ MHz}$, Figure 1) ($f = 60 \text{ MHz}$, figure 3) ($f = 200 \text{ MHz}$, figure 3)	MFE120 MFE121 MFE121	NF	-	2.9	5.0	dB

MFE120-MFE122

DUAL GATE MOSFETS

MECHANICAL CHARACTERISTICS

Case:	TO-72
Marking:	Alpha-numeric
Pin out:	See below

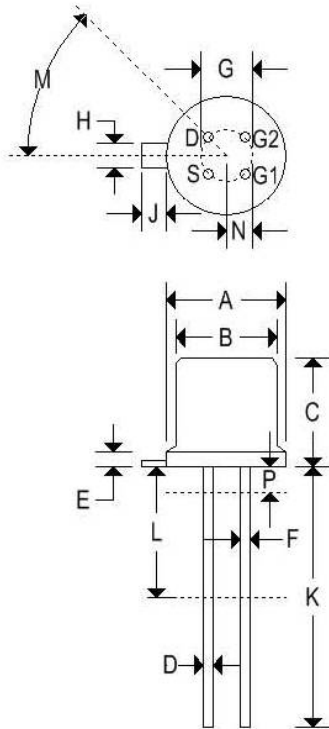

	TO-72			
	Inches		Millimeters	
	Min	Max	Min	Max
A	-	0.230	-	5.840
B	-	0.195	-	4.950
C	-	0.210	-	5.330
D	-	0.021	-	0.530
E	-	0.030	-	0.760
F	-	0.019	-	0.480
G	0.100 BSC		2.540 BSC	
H	-	0.046	-	1.170
J	-	0.048	-	1.220
K	0.500	-	12.700	-
L	0.250	-	-	6.350
M	45° BSC		45° BSC	
N	0.050 BDC		1.270 BSC	
P	-	0.050	-	1.270

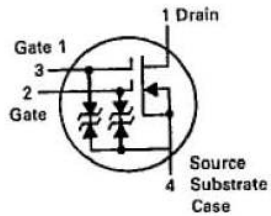

MFE120-MFE122

DUAL GATE MOSFETS

FIGURE 1 – 105 MHz TEST CIRCUIT

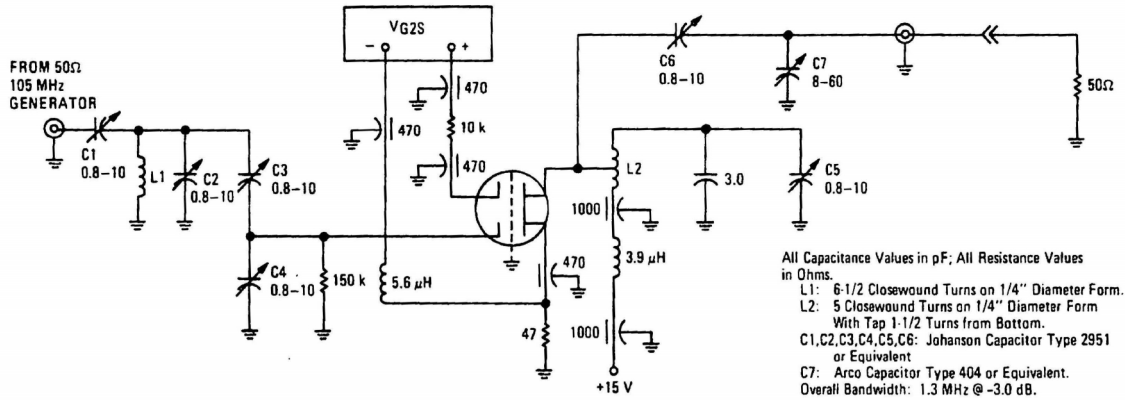

FIGURE 2 – 60 AND 200 MHz TEST CIRCUIT

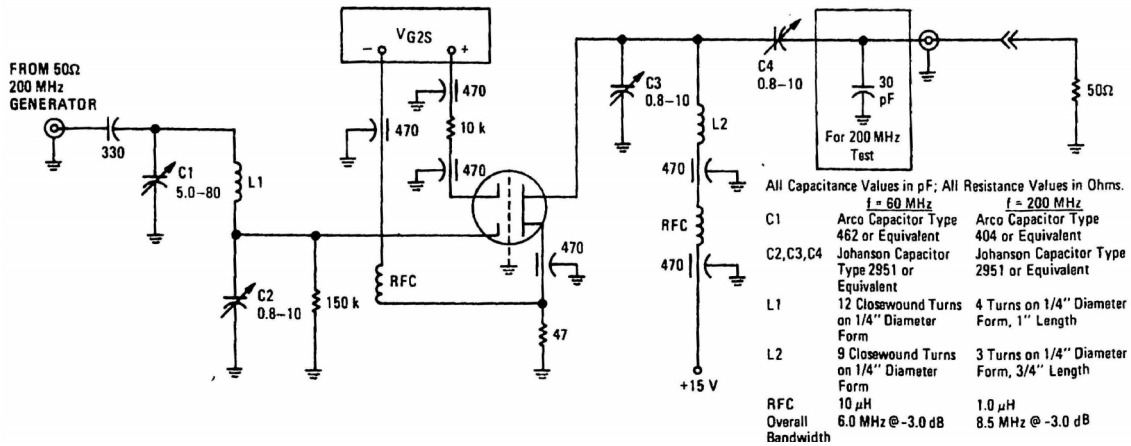
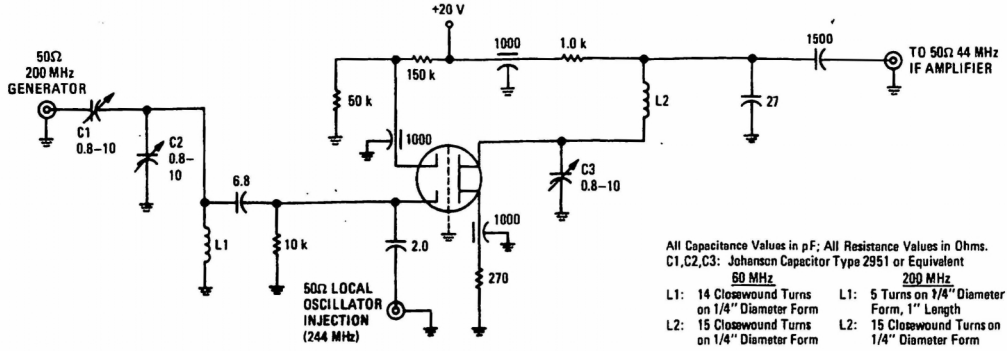

FIGURE 3 - 60 AND 200 MHz CONVERSION POWER GAIN



COMMON-SOURCE ADMITTANCE PARAMETERS
($V_{DS} = 15$ Vdc, $V_{GS} = 4.0$ Vdc, $I_D = 6.0$ mAdc)

FIGURE 4 - INPUT ADMITTANCE

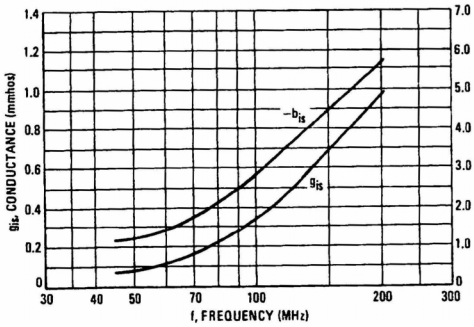

FIGURE 5 - REVERSE TRANSFER ADMITTANCE

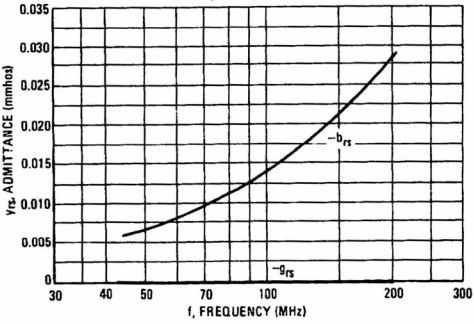

FIGURE 6 - FORWARD TRANSFER ADMITTANCE

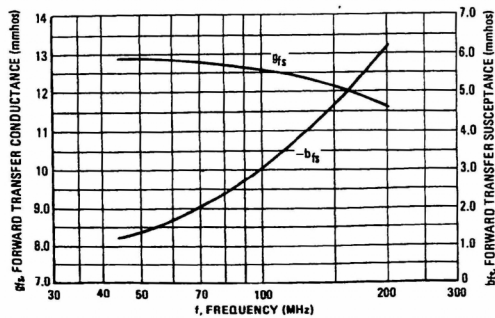
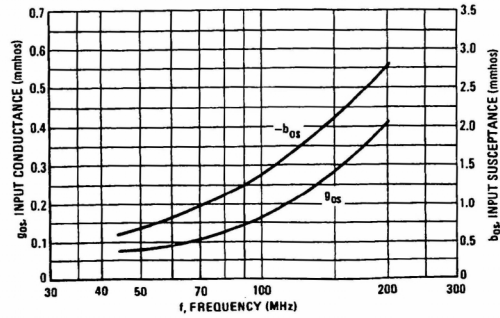

FIGURE 7 - OUTPUT ADMITTANCE



MFE120-MFE122

DUAL GATE MOSFETS

FIGURE 8 – GAIN REDUCTION

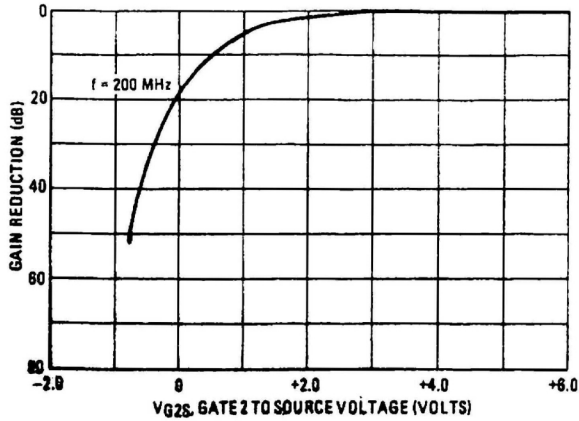

FIGURE 9 – CONVERSION POWER GAIN

