



MG120R040

主要参数 MAIN CHARACTERISTICS

I_D	60A
V_{CE}	1200V
$R_{dson-typ}$ (@ $V_{gs}=18V$)	45 m Ω
Q_g-typ	128nC

用途

- 光伏逆变器
- 开关模式电源
- 高压 DC/DC 转换器
- 电池充电器
- 电动驱动
- 脉冲电源应用

APPLICATIONS

- Solar Inverters
- Switch Mode Power Supplies
- High Voltage DC/DC Converters
- Battery Chargers
- Motor Drives
- Pulsed Power applications

产品特性

- 高阻断电压
- 低导通电阻
- 低电容高速开关
- 易于驱动
- 雪崩强度高
- RoHS 产品

FEATURES

- High Blocking Voltage
- Low On-Resistance
- High Speed Switching with Low Capacitances
- Easy to Parallel and Simple to Drive
- Avalanche Ruggedness
- RoHS product

封装 Package

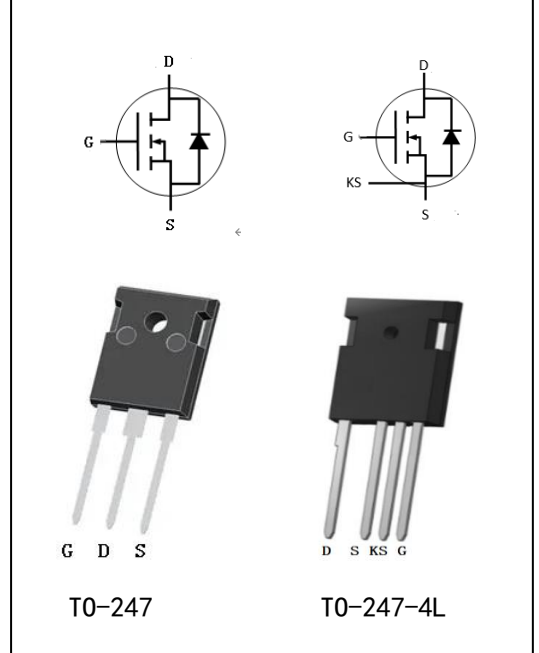

订货信息 ORDER MESSAGE

订货型号 Order codes	印记 Marking	封装 Package
无卤-条管 Halogen-Free-Tube		
MG120R040-GE-BR	MG120R040	TO-247
MG120R040-GH-BR	MG120R040	TO-247-4L



绝对最大额定值 ABSOLUTE RATINGS (Tc=25°C)

项 目 Parameter	符 号 Symbol	数 值 Value	单 位 Unit	测试条件 Tests conditions
最高漏极-源极直流电压 Drain-Source Voltage	V _{DSmax}	1200	V	V _{GS} =0V, I _D =100μA
最高栅源电压 Gate-Source Voltage	V _{GSmax}	-8/+20	V	Absolute maximum values
工作栅源电压 Gate-Source Voltage	V _{GSop}	-5/+18	V	Recommended operational values
连续漏极电流 Drain Current -continuous	I _D	60	A	V _{GS} =20V, T _C =25°C
		40	A	V _{GS} =20V, T _C =100°C
最大脉冲漏极电流 Drain Current - pulse	I _{DM}	100	A	Pulse width limited by T _{Jmax}
耗散功率 Power Dissipation	P _D	312	W	T _C =25°C, T _J =175°C
最高结温及存储温度 Operating and Storage Temperature Range	T _J , T _{STG}	-55~+175	°C	
引线最高焊接温度 Maximum Lead Temperature for Soldering Purposes	T _L	300	°C	





电特性 ELECTRICAL CHARACTERISTICS

项 目 Parameter	符 号 Symbol	测试条件 Tests conditions	最小 Min	典型 Typ	最大 Max	单位 Units
漏-源击穿电压 Drain-Source Voltage	BV_{DSS}	$I_D=100\mu A, V_{GS}=0V$	1200	-	-	V
阈值电压 Gate Threshold Voltage	$V_{GS(th)}$	$V_{DS} = V_{GS}, I_D=10mA, T_C=25^\circ C$	2.0	3.2	4	V
		$V_{DS} = V_{GS}, I_D=10mA, T_C=175^\circ C$		2		
零栅压下漏极漏电流 Zero Gate Voltage Drain Current	I_{DSS}	$V_{DS}=1200V, V_{GS}=0V, T_C=25^\circ C$	-	1	100	μA
栅极体漏电流 Gate-body leakage current	I_{GSS}	$V_{DS}=0V, V_{GS} =20V$	-	50	200	nA
导通电阻 Drain-Source On-Resistance	$R_{DS(ON)}$	$V_{GS} =18V, I_D=33A, T_C=25^\circ C$	-	45	60	m Ω
		$V_{GS} =18V, I_D=33A, T_C=175^\circ C$		68		m Ω
跨导 Transconductance	g_{fs}	$V_{DS} = 20V, I_D=33A, T_J = 25^\circ C$	-	20	-	S
		$V_{DS} = 20V, I_D=33A, T_J =175^\circ C$		18.3		S
输入电容 Input capacitance	C_{iss}	$V_{DS}=1000V,$ $V_{GS} =0V,$ $f=1.0MHz,$ $V_{AC}=25mV$	-	3700	-	pF
输出电容 Output capacitance	C_{oss}		-	120	-	pF
反向传输电容 Reverse transfer capacitance	C_{rss}		-	22	-	pF
导通开关能量 Turn-On Switching Energy	E_{ON}	$V_{DS}=800V, V_{GS}=-5/18V, I_D= 33A,$ $R_{G(ext)} = 5\Omega, L= 80\mu H$	-	1.2	-	mJ
关断开关能量 Turn-Off Switching Energy	E_{OFF}		-	0.44	-	
延迟时间 Turn-On delay time	$t_{d(on)}$	$V_{DD}=800V, V_{GS}=-5/18V$ $I_D =33A, R_{G(ext)} = 5\Omega,$ Timing relative to VDS	-	69	-	ns
上升时间 Turn-On rise time	t_r		-	140	-	ns
延迟时间 Turn-Off delay time	$t_{d(off)}$		-	50	-	ns
下降时间 Turn-Off Fall time	t_f		-	42	-	ns
栅电阻 Intrinsic gate resistance	R_G	$f = 1 MHz, V_{AC}=25mV$	-	2.1	-	Ω
栅-源电荷 Gate-Source charge	Q_{gs}	$V_{DD}=800V, V_{GS}=-5/18V I_D = 33A$		40		nC
栅-漏电荷 Gate-Drain charge	Q_{gd}			37		
栅极电荷总量 Total Gate Charge	Q_g			28		



漏-源二极管特性 Drain-Source Diode Characteristics

项 目 Parameter	符 号 Symbol	测试条件 Tests conditions	典型 Typ	最大 Max	单位 Units
正向压降 Drain-Source Diode Forward Voltage	V_{SD}	$V_{GS} = -5V, I_{SD} = 20 A, T_J = 25\text{ }^{\circ}C$	3.6		V
		$V_{GS} = -5V, I_{SD} = 20 A, T_J = 175\text{ }^{\circ}C$	3.3		V
正向最大连续电流 Maximum Continuous Drain -Source Diode Forward Current	I_S	$T_C = 25\text{ }^{\circ}C$	-	60	A
反向恢复时间 Reverse recovery time	t_{rr}		37		ns
反向恢复电荷 Reverse recovery charge	Q_{rr}	$V_{GS} = -5V, I_{SD} = 33 A, V_R = 800V,$ $dif/dt = 1200A/\mu s$	165		nC
峰值反向恢复电流 Peak Reverse Recovery Current	I_{rrm}		16		A

热特性 THERMAL CHARACTERISTIC

项 目 Parameter	符 号 Symbol	典型 Typ	单位 Unit
结到管壳的热阻 Thermal Resistance, Junction to Case	$R_{th(j-c)}$	0.48	$^{\circ}C/W$
结到环境的热阻 Thermal Resistance, Junction to Ambient	$R_{th(j-A)}$	42	$^{\circ}C/W$





典型性能 Typical Performance

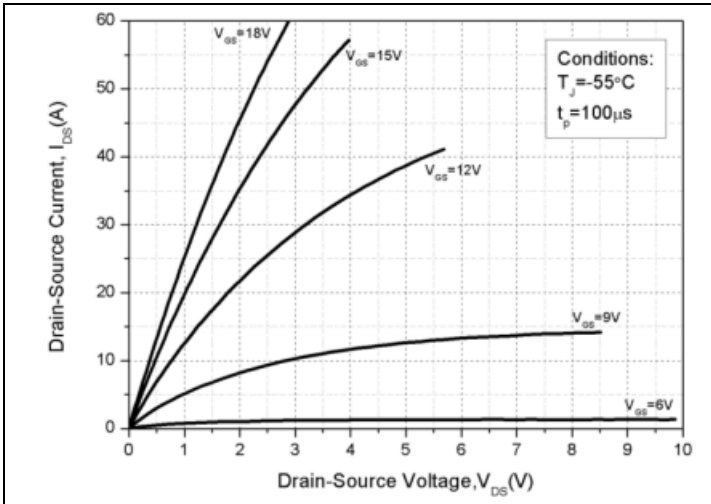

Output Characteristics $T_J = -55^\circ\text{C}$

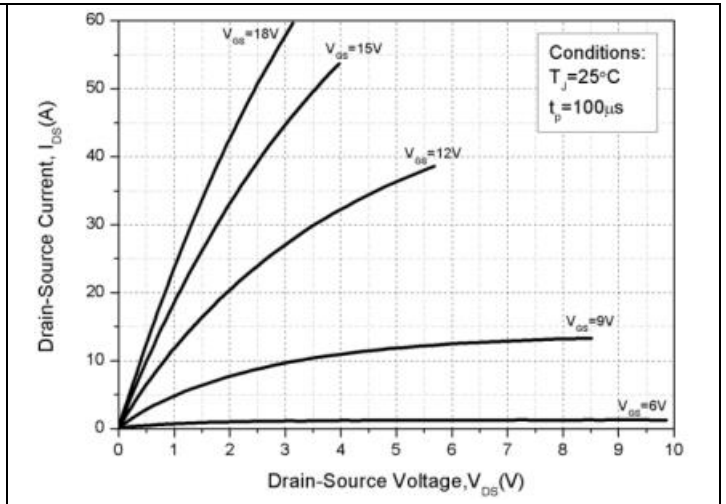

Output Characteristics $T_J = 25^\circ\text{C}$

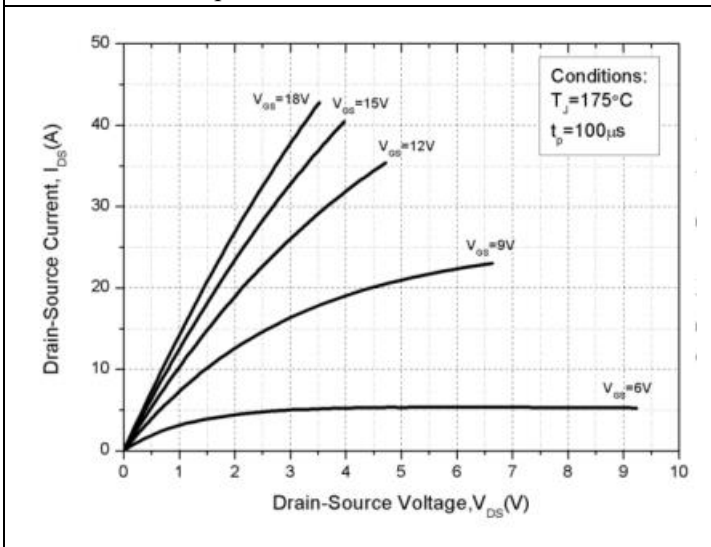

Output Characteristics $T_J = 175^\circ\text{C}$

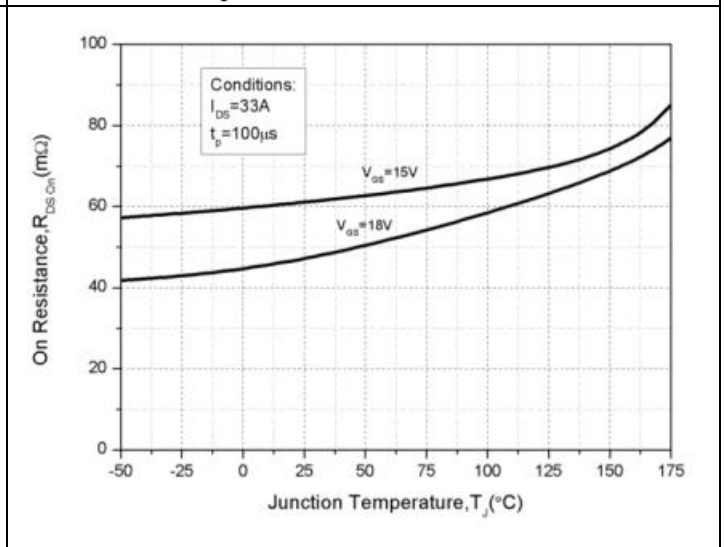

On-Resistance For Various Gate Voltage

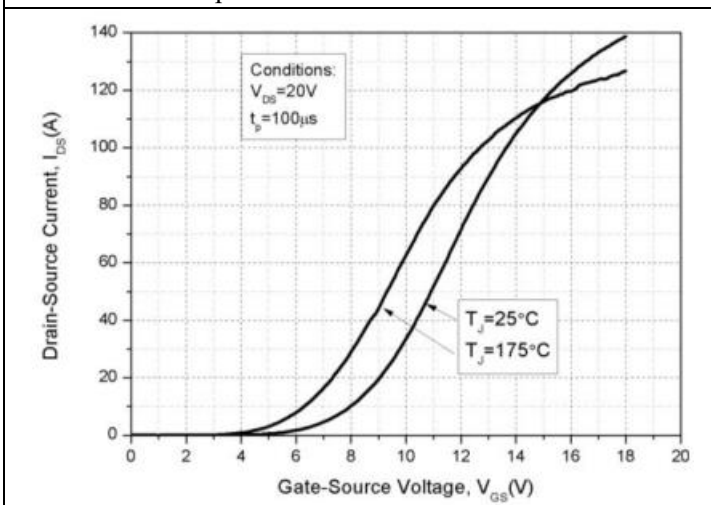

Transfer Characteristic

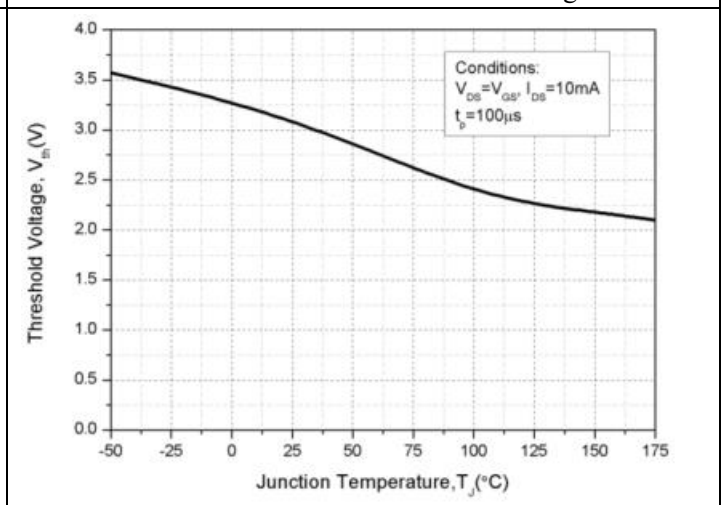

Threshold Voltage vs. Temperature or Various Junction Temperatures

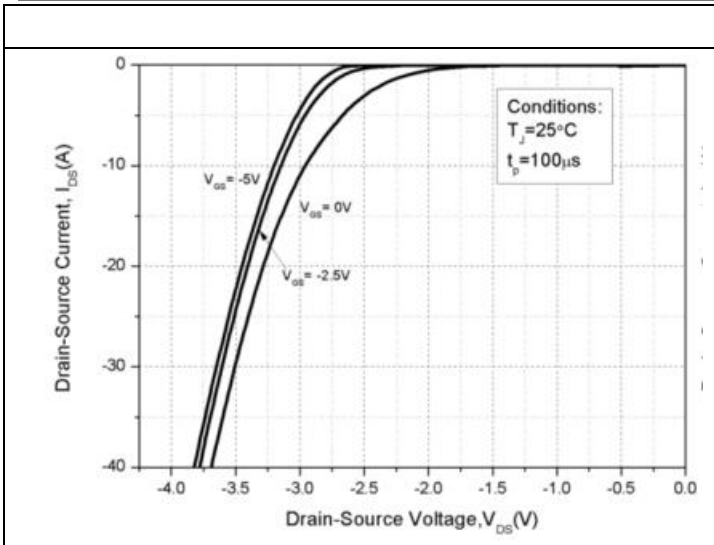

Body Diode Characteristics, $T_j = 25^\circ\text{C}$

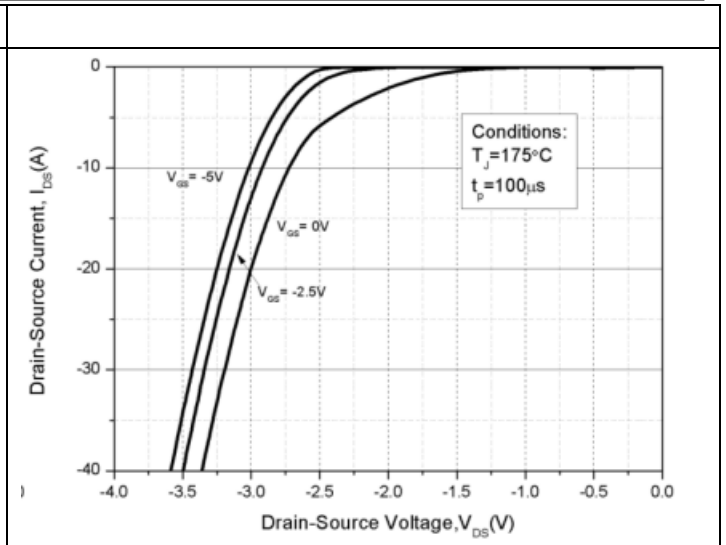

Body Diode Characteristics, $T_j = 175^\circ\text{C}$

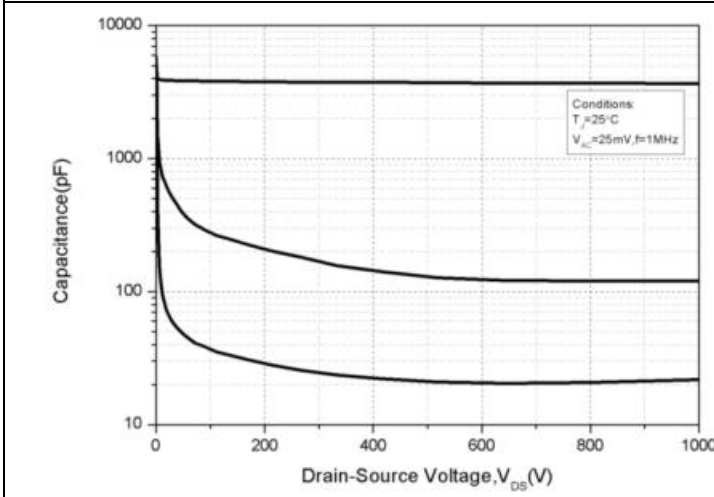

Capacitances vs. Drain-Source Voltage

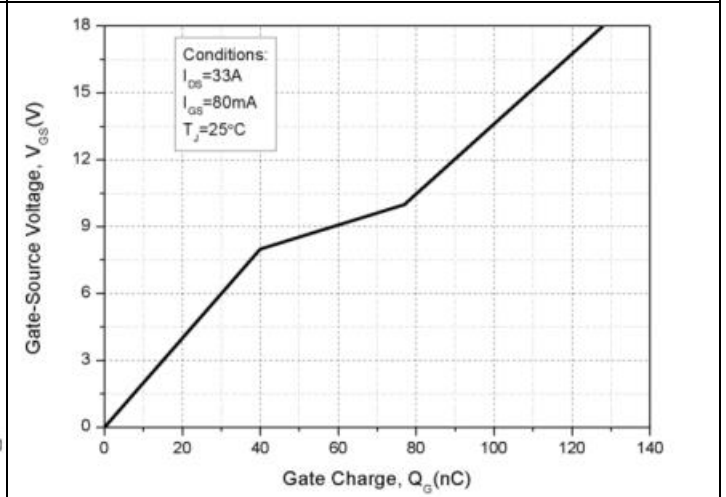

Gate Charge Characteristics

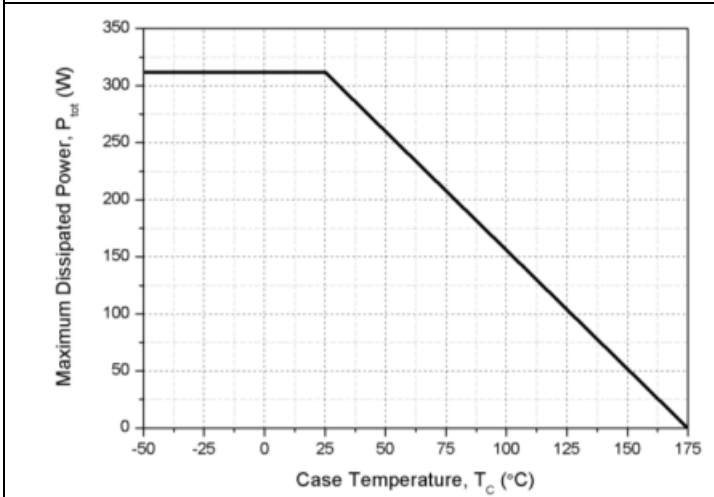

Power Dissipation Derating

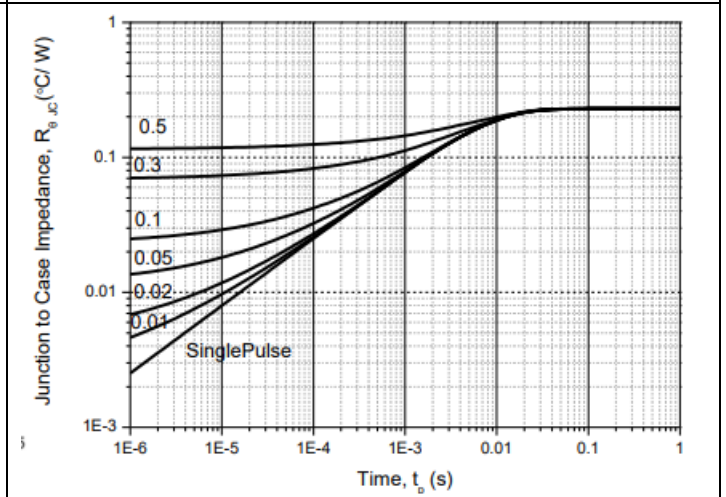

Transient Thermal Impedance



外形尺寸 PACKAGE MECHANICAL DATA

TO-247-4L

单位 Unit: mm

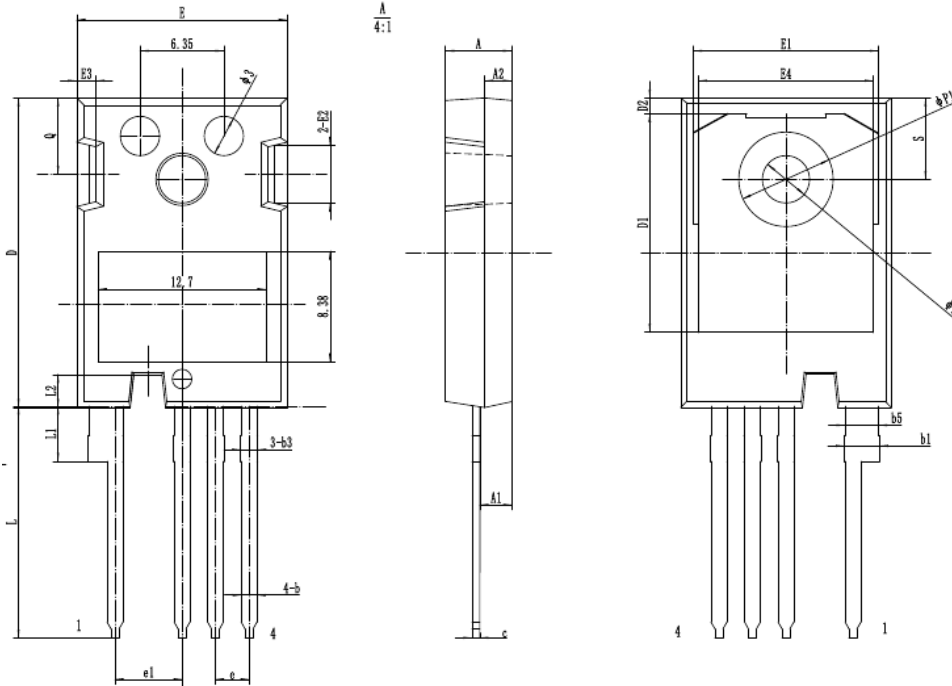

SYMBOL	mm		
	MIN	NOM	MAX
*A	4.83	5.02	5.21
A1	2.29	2.41	2.54
A2	1.91	2.00	2.16
*b	1.07	1.20	1.33
b1	2.39	2.67	2.94
b3	1.07	1.30	1.60
b5	2.39	2.53	2.69
*c	0.55	0.60	0.68
*D	23.30	23.45	23.60
D1	16.25	16.55	17.65
D2	0.95	1.19	1.25
*E	15.75	15.94	16.13
E1	13.10	14.02	14.15
E2	3.68	4.40	5.10
E3	1.00	1.45	1.90
E4	12.38	13.26	13.43
*e	2.54BSC		
e1	5.08BSC		
*L	17.31	17.57	17.82
*L1	3.97	4.19	4.37
*L2	2.30	2.50	2.65
*φP	3.51	3.61	3.65
*φP1	7.19REF		
*Q	5.49	5.79	6.00
S	6.04	6.17	6.30



TO-247

单位 Unit: mm

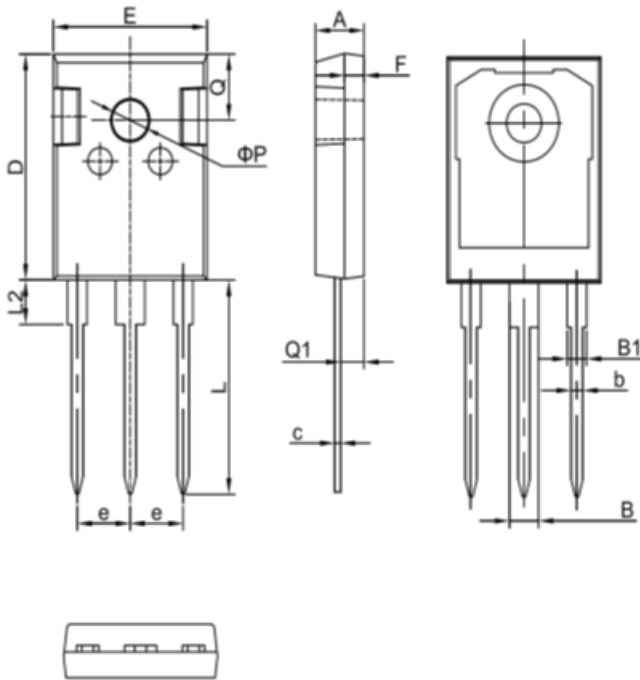

符号 symbol	MIN	MAX
A	4.90	5.10
B	2.95	3.35
B1	1.95	2.35
b	1.15	1.35
c	0.50	0.70
D	20.90	21.10
E	15.70	15.90
e	5.34	5.54
F	1.90	2.10
L	19.40	20.40
L2	4.03	4.23
Q	6.00	6.40
Q1	2.30	2.50
P	3.50	3.70

←





注意事项

1. 吉林华微电子股份有限公司的产品销售分为直销和销售代理，无论哪种方式，订货时请与公司核实。
2. 购买时请认清公司商标，如有疑问请与公司本部联系。
3. 在电路设计时请不要超过器件的绝对最大额定值，否则会影响整机的可靠性。
4. 本说明书如有版本变更不另外告知。

NOTE

1. Jilin Sino-microelectronics co., Ltd sales its product either through direct sales or sales agent , thus, for customers, when ordering , please check with our company.
2. We strongly recommend customers check carefully on the trademark when buying our product, if there is any question, please don't be hesitate to contact us.
3. Please do not exceed the absolute maximum ratings of the device when circuit designing.
4. Jilin Sino-microelectronics co., Ltd reserves the right to make changes in this. specification sheet and is subject to change without prior notice.

联系方式

吉林华微电子股份有限公司

公司地址：吉林省吉林市深圳街 99 号

邮编：132013

总机：86-432-64678411

传真：86-432-64665812

网址：www.hwdz.com.cn

CONTACT

JILIN SINO-MICROELECTRONICS CO., LTD.

ADD: No.99 Shenzhen Street, Jilin City, Jilin Province, China.

Post Code: 132013

Tel: 86-432-64678411

Fax: 86-432-64665812

Web Site: www.hwdz.com.cn

