

9097250 TOSHIBA (DISCRETE/OPTO)

90D 16230 DT-33-35



SEMICONDUCTOR
TECHNICAL DATA

- MG50G1BL3
- MG50G1JL1
- MG50G2CL3
- MG50G2DL1
- MG50G6EL1

Unit in mm

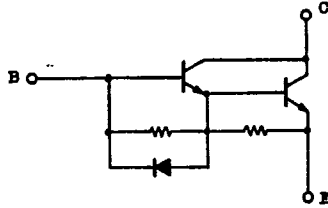

MG50G1BL3

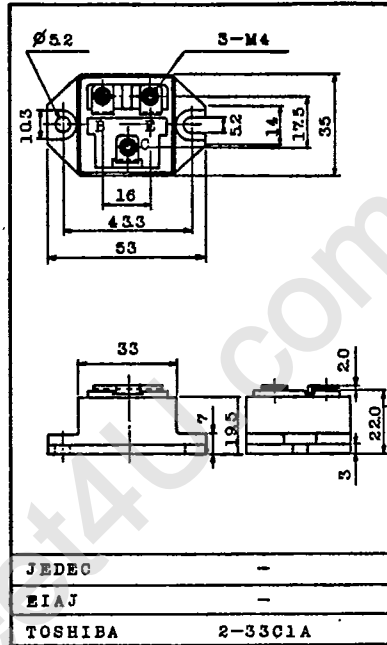

Weight : 86g

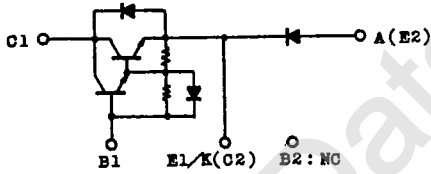

MG50G1JL1

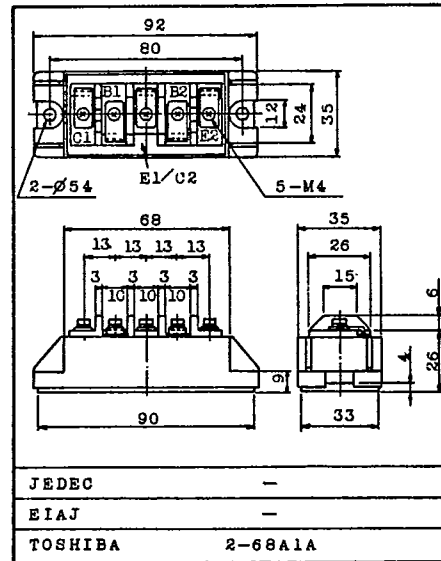

Weight : 210g

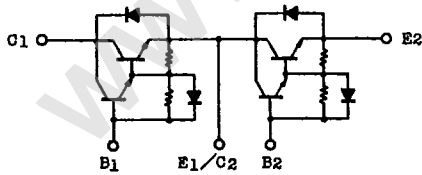

MG50G2CL3

TOSHIBA CORPORATION

GT1A2A

9097250 TOSHIBA (DISCRETE/OPTO)

90D 16231 DT-33-35



SEMICONDUCTOR
TECHNICAL DATA

- MG50G1BL3
- MG50G1JL1
- MG50G2CL3
- MG50G2DL1
- MG50G6EL1

Unit in mm

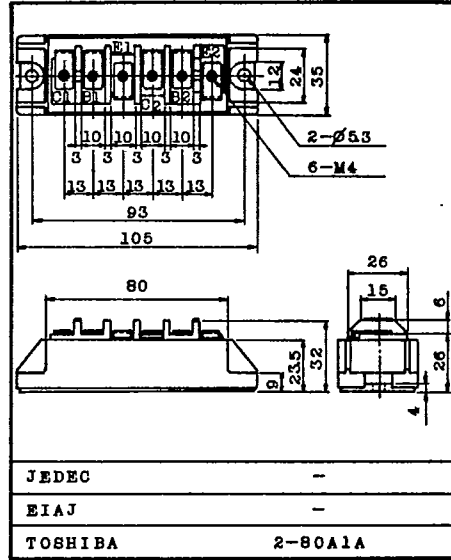
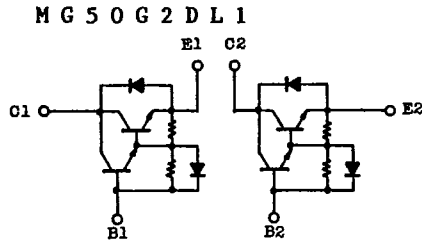

Weight : 245g

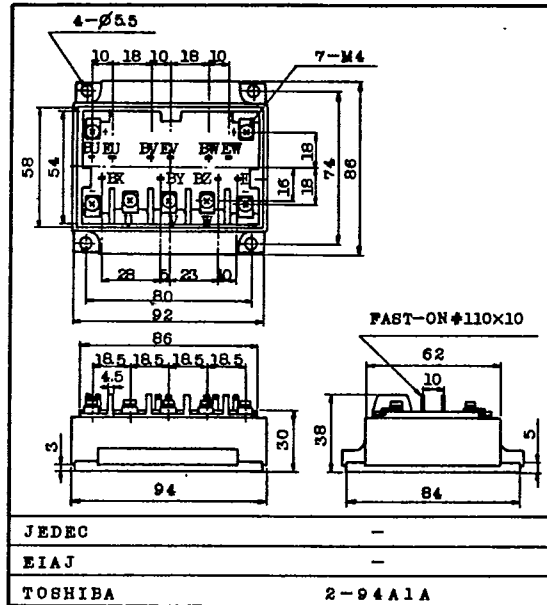
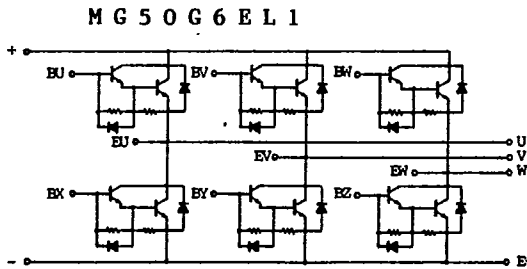

Weight : 600g

TOSHIBA CORPORATION

GT1A2A

9097250 TOSHIBA (DISCRETE/OPTO)

90D 16232 DT-33-35



SEMICONDUCTOR

東芝

TECHNICAL DATA

M G 5 0 G 1 B L 3

M G 5 0 G 1 J L 1

M G 5 0 G 2 C L 3

M G 5 0 G 2 D L 1

M G 5 0 G 6 E L 1

MAXIMUM RATINGS (Ta=25°C)

CHARACTERISTIC		SYMBOL	RATING	UNIT
Collector-Base Voltage		V _{CB0}	600	V
Collector-Emitter Voltage		V _{CEO}	600	V
Collector-Emitter Sustaining Voltage		V _{CEO(SUS)}	450	V
Emitter-Base Voltage		V _{EB0}	6	V
Collector Current	DC	I _C	50	A
	1ms	I _C	100	A
	DC	-I _C	50	A
Base Current		I _B	3	A
Collector Power Dissipation (Tc=25°C)		P _C	300	W
Junction Temperature		T _j	150	°C
Storage Temperature Range		T _{stg}	-40~125	°C
Isolation Voltage		V _{Isol}	2500 (AC 1 Minute)	V
Screw Torque (Terminal/Mounting)			20/30	kg·cm

ELECTRICAL CHARACTERISTICS (Ta=25°C)

CHARACTERISTIC		SYMBOL	TEST CONDITION	MIN.	TYP.	MAX.	UNIT
Collector Cut-off Current		I _{CBO}	V _{CB} =600V, I _E =0	-	-	1.0	mA
Emitter Cut-off Current		I _{EB0}	V _{EB} =6V, I _C =0	-	-	200	mA
Collector-Emitter Sustaining Voltage		V _{CEO(SUS)}	I _C =0.5A, L=40mH	450	-	-	V
DC Current Gain		h _{FE}	V _{CE} =5V, I _C =50A	100	-	-	
Collector-Emitter Saturation Voltage		V _{CE(sat)}	I _C =50A, I _B =1A	-	-	2.0	V
Base-Emitter Saturation Voltage		V _{BE(sat)}		-	-	2.5	V
Emitter-Collector Voltage		V _{ECO}	I _E =50A, I _B =0	-	-	1.5	V
Reverse Recovery Time		t _{rr}	-I _C =50A, V _{EB} =3V, V _{CE} =300V	-	-	2.0	μs
Switching Time	Turn-on Time	t _{on}		-	-	1.0	μs
	Storage Time	t _{stg}		-	-	12	
	Fall Time	t _f		-	-	2.0	
Thermal Resistance (Junction to Case)		R _{th(j-c)}	Transistor	-	-	0.41	°C/W
			Diode	-	-	1.3	

TOSHIBA CORPORATION

GT1A2

9097250 TOSHIBA (DISCRETE/OPTO)

90D 16233

DT-33-35



SEMICONDUCTOR

TECHNICAL DATA

- MG 50 G 1 B L 3
- MG 50 G 1 J L 1
- MG 50 G 2 C L 3
- MG 50 G 2 D L 1
- MG 50 G 6 E L 1

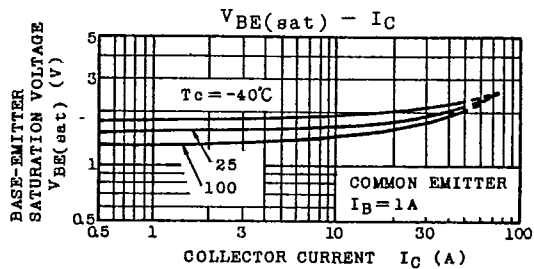
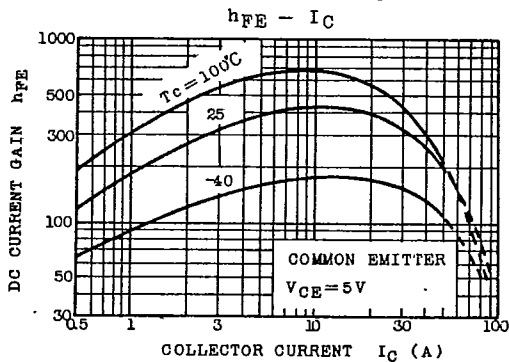
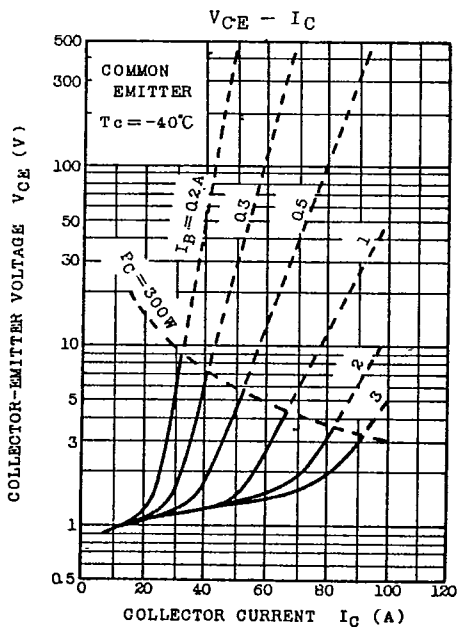
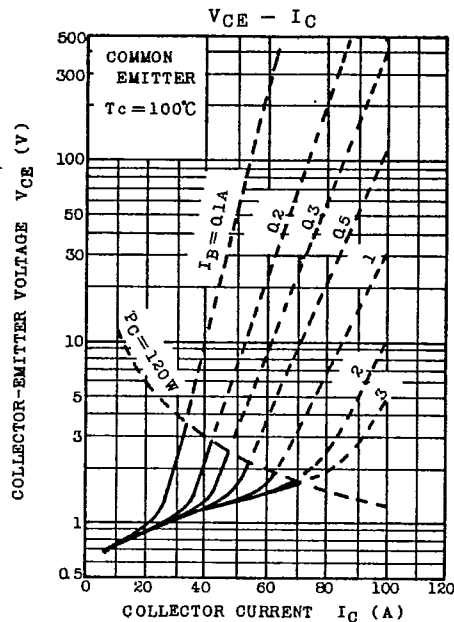
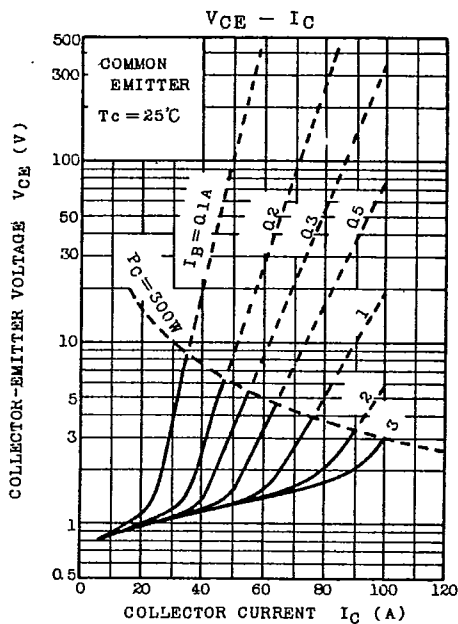

TOSHIBA CORPORATION

GT1A2

9097250 TOSHIBA (DISCRETE/OPTO)

90D 16234

DT-33-35



SEMICONDUCTOR

TECHNICAL DATA

- MG 5 0 G 1 B L 3
- MG 5 0 G 1 J L 1
- MG 5 0 G 2 C L 3
- MG 5 0 G 2 D L 1
- MG 5 0 G 6 E L 1

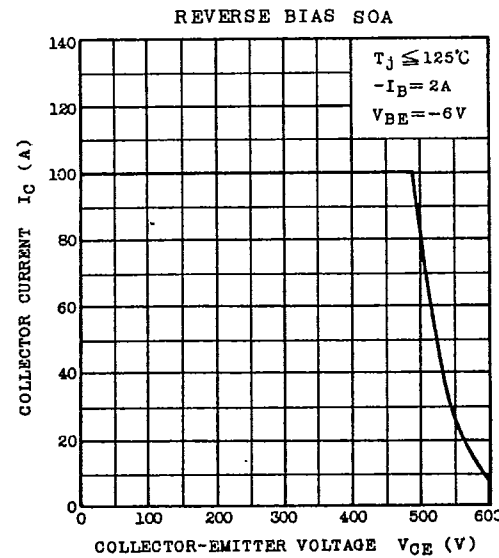
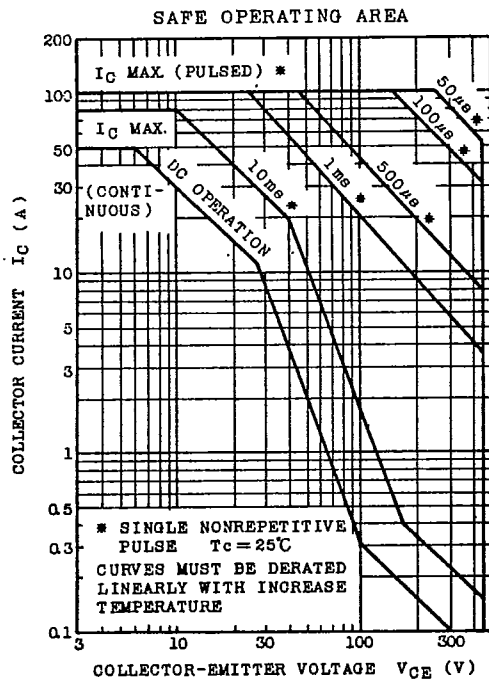
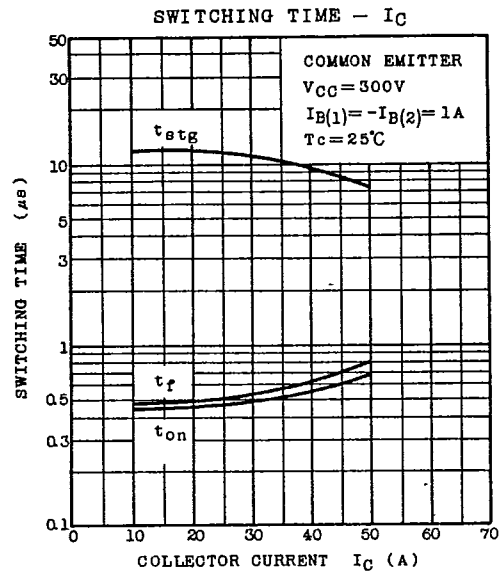
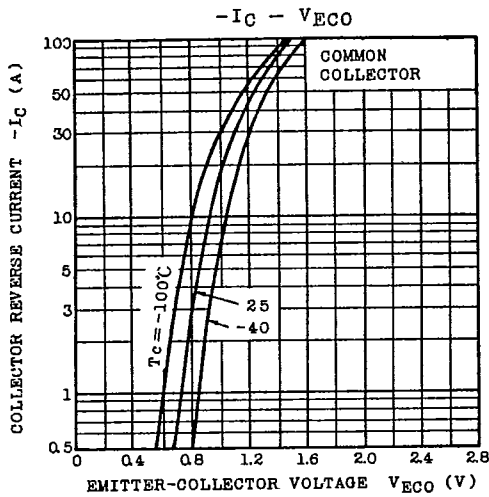

TOSHIBA CORPORATION

GT1A2

9097250 TOSHIBA (DISCRETE/OPTO)

90D 16235 DT-33-35



SEMICONDUCTOR
TECHNICAL DATA

- MG50G1BL3
- MG50G1JL1
- MG50G2CL3
- MG50G2DL1
- MG50G6EL1

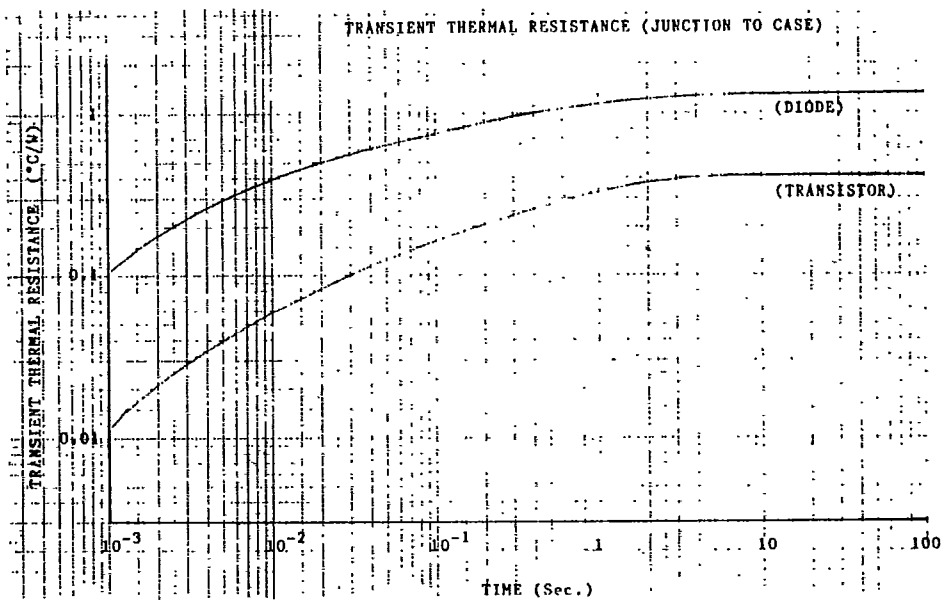
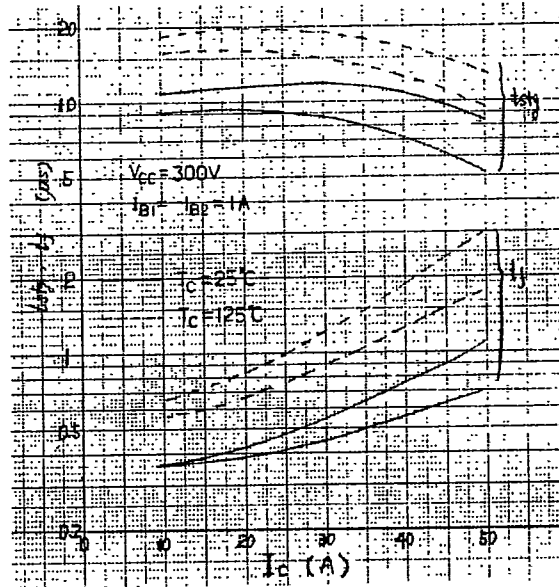

TOSHIBA CORPORATION

GT1A2A



SEMICONDUCTOR
TECHNICAL DATA

- MG50G1BL3
- MG50G1JL1
- MG50G2CL3
- MG50G2DL1
- MG50G6EL1

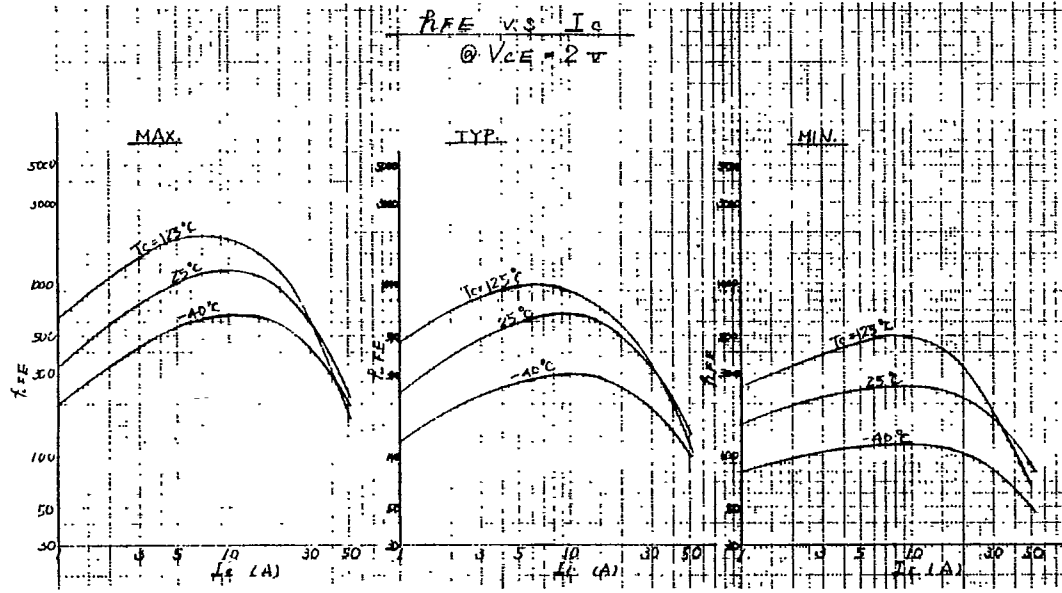
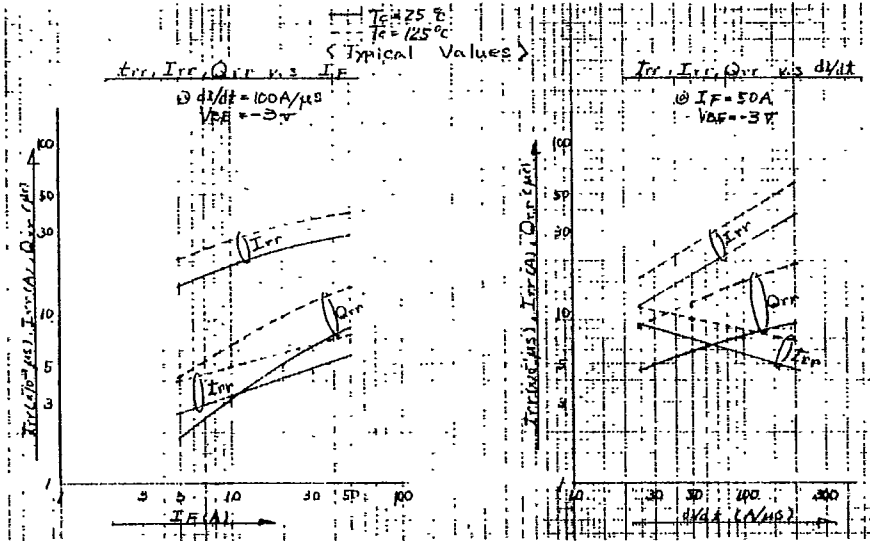

TOSHIBA CORPORATION