

MGA-31689

0.5 W High Gain Driver Amplifier



Data Sheet

Description

Avago Technologies' MGA-31689 is a 0.5 W, high Gain, high performance Driver Amplifier MMIC, housed in a standard SOT-89 plastic package. The device required simple matching components to achieve optimum performance within specific 100 to 200 MHz bandwidth.

MGA-31689 is especially ideal for wireless infrastructure applications that operate within the 1.5 GHz to 3 GHz frequency range. With high IP3 and low noise figure, the MGA-31689 may be utilized as a driver amplifier in the transmit chain and as second or third stage LNA in the receive chain. For optimum performance at lower frequency from 450 MHz to 1500 MHz, MGA-31589 is recommended.

MGA-31689's high gain and high linearity features are achieved through the use of Avago Technologies' proprietary 0.25 μm GaAs Enhancement-mode pHEMT process.

Pin connections and Package Marking

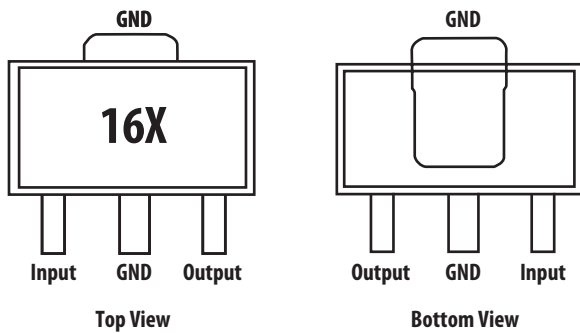

Note:
 Top View: Package marking provides orientation and identification
 "16" = Device Code
 "X" = Date Code character identifies month of manufacturing

Attention: Observe precautions for handling electrostatic sensitive devices.
 ESD Machine Model = 150 V
 ESD Human Body Model = 650 V
 Refer to Avago Application Note A004R: Electrostatic Discharge, Damage and Control.

Features

- ROHS compliant
- Halogen free
- High linearity at low DC bias power^[1]
- High Gain
- Low noise figure
- High OIP3
- Advanced enhancement mode PHEMT Technology
- Excellent uniformity in product specification
- SOT-89 standard package

Specifications

At 1900 MHz, Vdd = 5 V, Idd = 168 mA (typical) at 25° C

- OIP3 = 44.9 dBm
- Noise Figure = 1.9 dB
- Gain = 18.1 dB
- P1dB = 27.6 dBm
- IRL = 14.0 dB, ORL = 11.5 dB

Note:

1. The MGA-31689 has a superior LFOM of 15.5. Linearity Figure of Merit (LFOM) is essentially OIP3 divided by DC bias power.

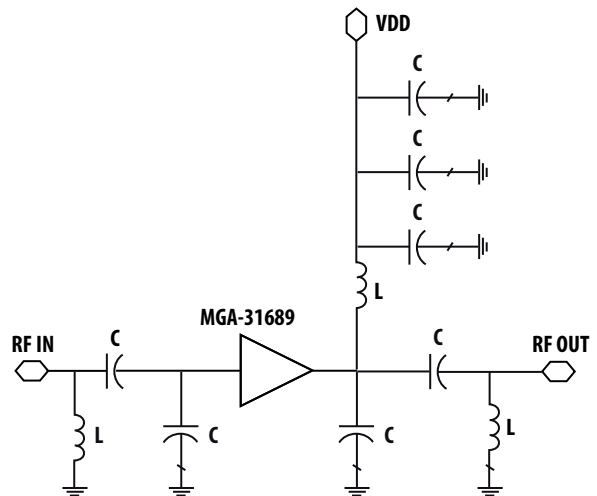

Figure 1. Simplified Schematic diagram

MGA-31689 Absolute Maximum Rating [1]

Symbol	Parameter	Units	Absolute Max.
$V_{dd, max}$	Drain Voltage, RF output to ground	V	5.5
P_d	Power Dissipation (2)	mW	1050
P_{in}	CW RF Input Power	dBm	15
T_j	Junction Temperature	°C	150
T_{STG}	Storage Temperature	°C	-65 to 150

Thermal Resistance

Thermal Resistance [3]

($V_{dd} = 5.0$ V, $I_{dd} = 168$ mA, $T_c = 85^\circ$ C),
 $\theta_{jc} = 44^\circ$ C/W

Notes:

1. Operation of this device in excess of any of these limits may cause permanent damage.
2. Source lead temperature is 25° C. Derate 22.7 mW/° C for $T_L > 103.8^\circ$ C.
3. Thermal resistance measured using 150° C Infra-Red Microscopy Technique.

MGA-31689 Electrical Specification [1]

$T_C = 25^\circ$ C, $Z_o = 50 \Omega$, $V_{dd} = 5$ V, unless specified.

Symbol	Parameter and Test Condition	Frequency	Units	Min.	Typ.	Max.
		(MHz)				
I_{ds}	Quiescent Current	NA	mA	150	168	195
NF	Noise Figure	1900 2600	dB		1.9 2.2	2.8
Gain	Gain	1900 2600	dB	16.6	18.1 16.7	19.6
OIP3	Output Third Order Intercept Point	1900 [2] 2600 [3]	dBm	41	44.9 44.8	
P1dB	Output Power at 1 dB Gain Compression	1900 2600	dBm	26.5	27.6 26.8	
PAE	Power Added Efficiency at P1dB	1900 2600	%		48.0 42.6	
IRL	Input Return Loss	1900 2600	dB		14.0 13.2	
ORL	Output Return Loss	1900 2600	dB		11.5 10.5	
ISOL	Isolation	1900 2600	dB		27.3 27.6	

Note :

1. Measurements obtained from a test circuit described in Figure 27.
2. OIP3 test condition: $F1 - F2 = 1.0$ MHz, with input power of -6 dBm per tone measured at worst case side band.
3. OIP3 test condition: $F1 - F2 = 1.0$ MHz, with input power of -5 dBm per tone measured at worst case side band.

MGA-31689 Consistency Distribution Charts [1,2]

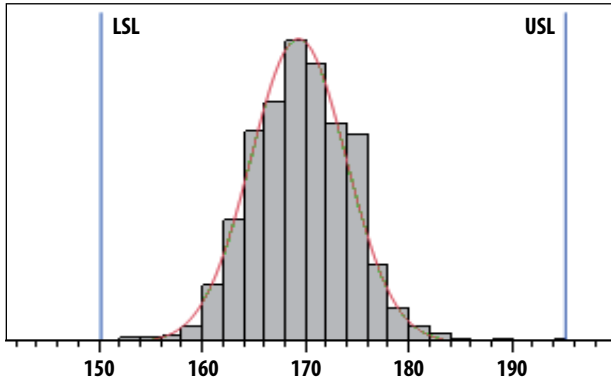

Figure 2. Idd at Vdd = 5 V, LSL = 150 mA, Nominal = 168 mA, USL = 195 mA

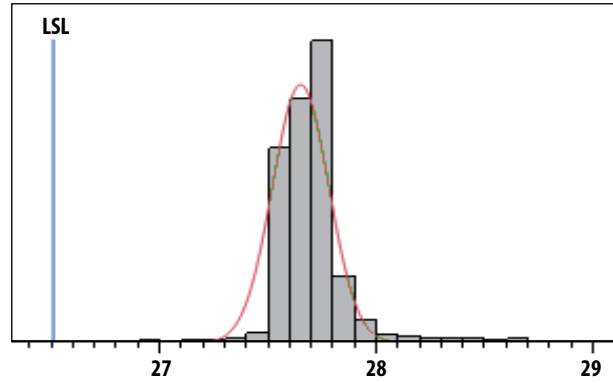

Figure 3. OP1dB at 1900 MHz, Vdd = 5 V, LSL = 26.3 dBm, Nominal = 27.6 dBm

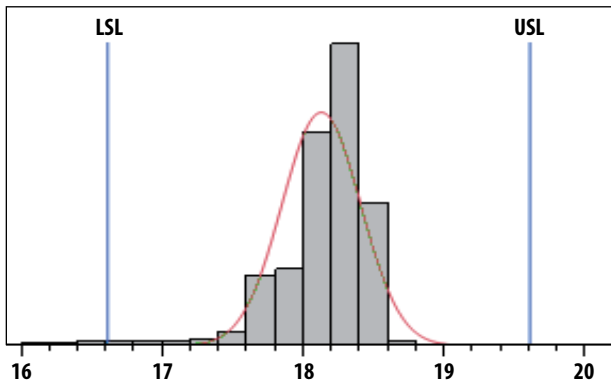

Figure 4. Gain at 1900 MHz, Vdd = 5 V, LSL = 16.6 dB, Nominal = 18.1 dB, USL = 19.6 dB

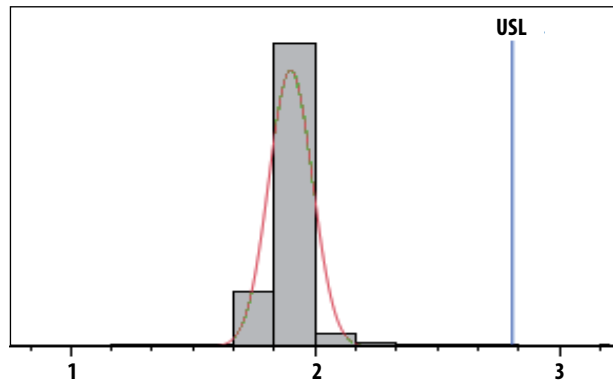

Figure 5. NF at 1900 MHz, Vdd = 5 V, Nominal = 1.9 dB, USL = 2.8 dB

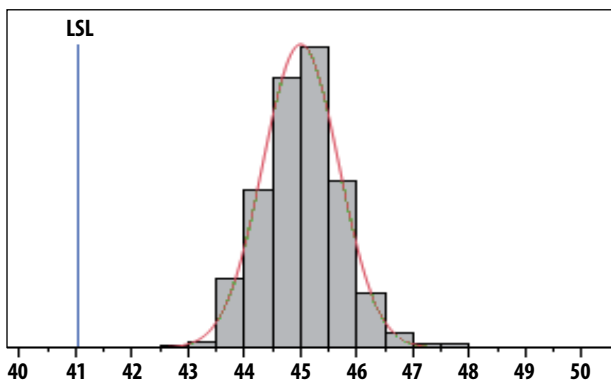

Figure 6. OIP3 at 1900 MHz, Vdd = 5 V, LSL = 41.0 dBm, Nominal = 44.9 dBm

Notes:

1. Data sample size is 2700 samples taken from 5 wafers and 3 different wafer lots. Future wafers allocated to this product may have nominal values anywhere between the upper and lower limits.
2. Measurements are made on production test board which represents a trade off between nominal Gain, NF, OIP3, and OP1dB. Circuit losses have been de-embedded from actual measurements.

MGA-31689 Application Circuit Data for 1900 MHz

$T_A = 25^\circ\text{C}$, $V_{dd} = 5.0\text{V}$, $I_{dd} = 168\text{mA}$

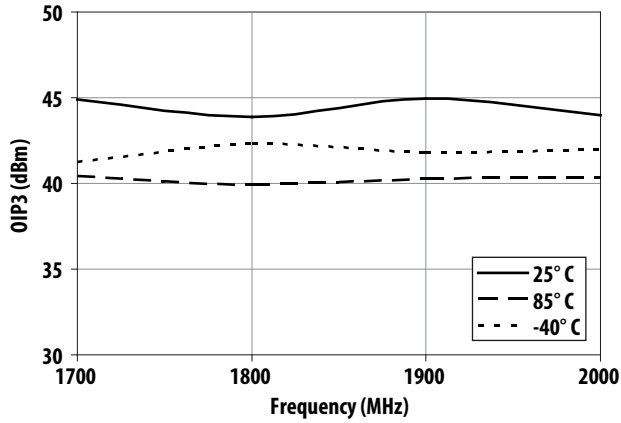

Figure 7. Over Temperature OIP3 vs Frequency

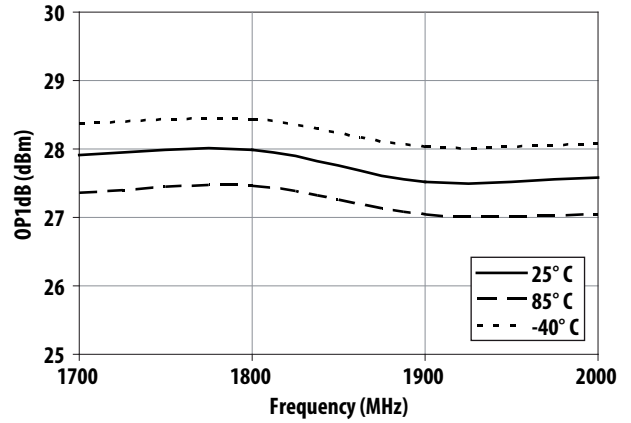

Figure 8. Over Temperature OP1dB vs Frequency

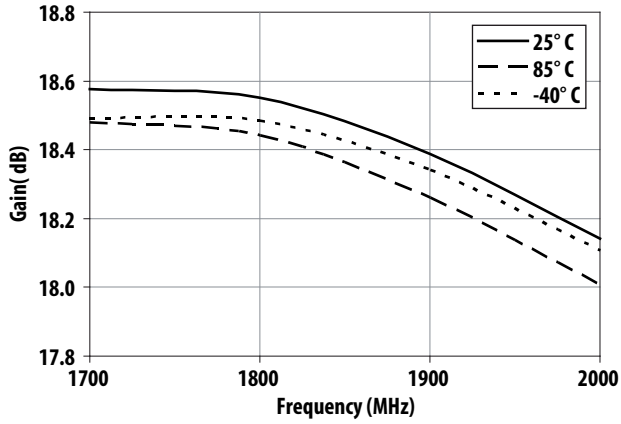

Figure 9. Over Temperature Gain vs Frequency

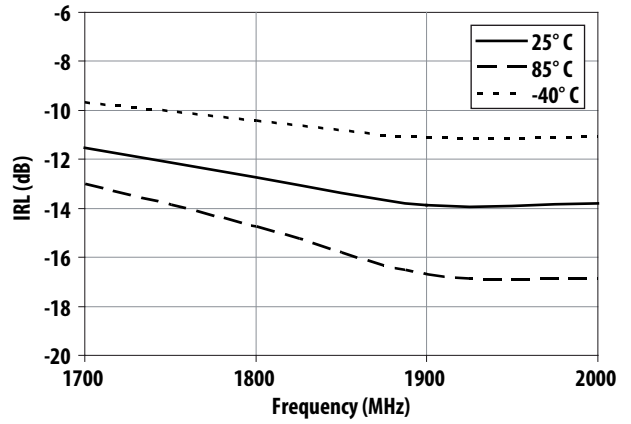

Figure 10. Over Temperature IRL vs Frequency

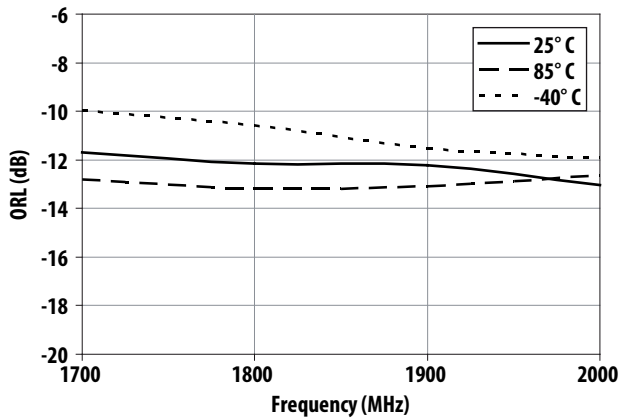

Figure 11. Over Temperature ORL vs Frequency

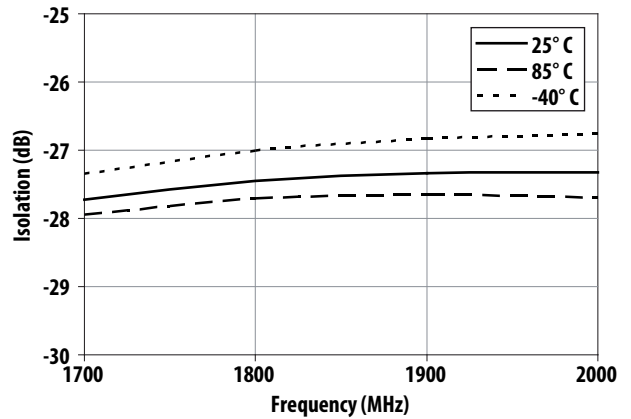

Figure 12. Over Temperature Isolation vs Frequency

MGA-31689 Application Circuit Data for 1900 MHz (continued)

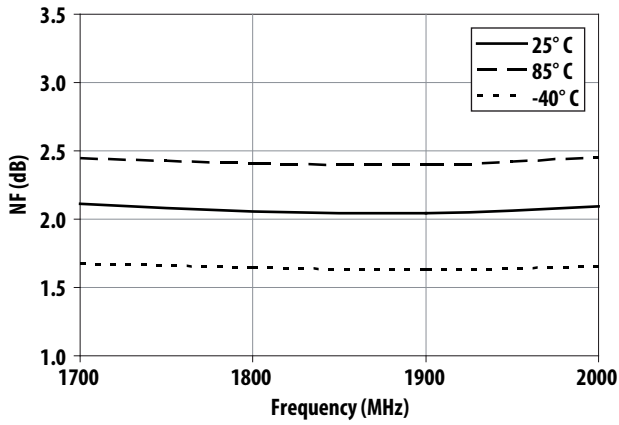

Figure 13. Over Temperature Noise Figure vs Frequency

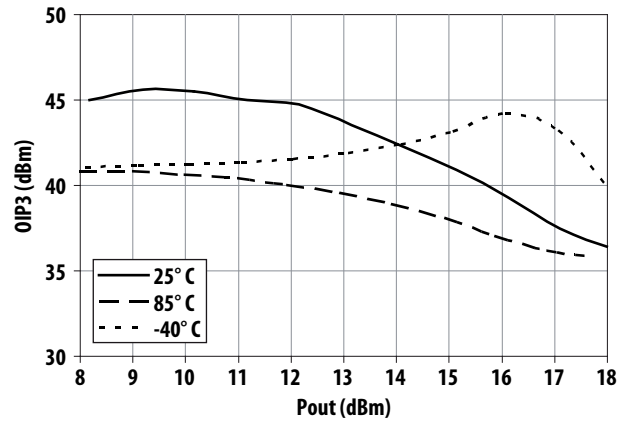

Figure 14. Over Temperature OIP3 vs Pout at 1900 MHz

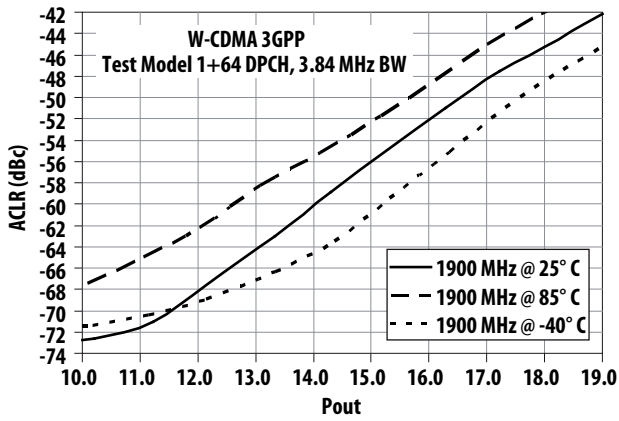

Figure 15. Over Temperature ACLR vs Pout at 1900 MHz

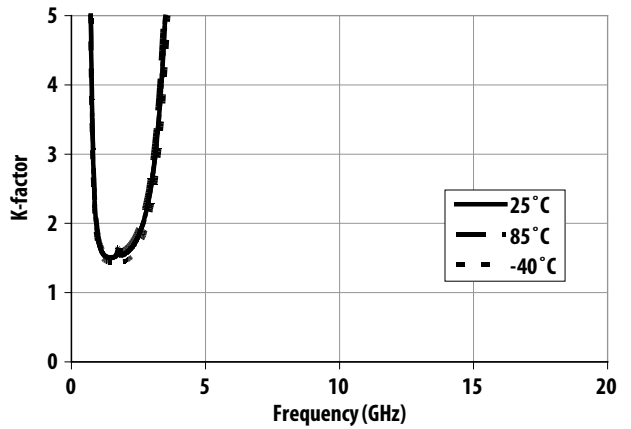

Figure 16. Over Temperature K-factor vs Frequency

MGA-31689 Application Circuit Data for 2600 MHz

$T_A = 25^\circ\text{C}$, $V_{dd} = 5.0\text{V}$, $I_{dd} = 168\text{mA}$

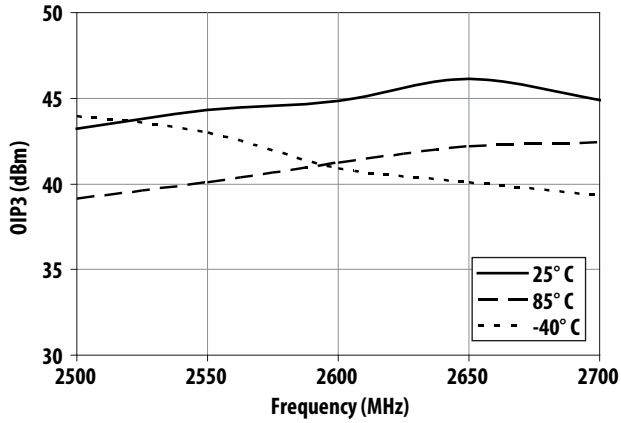

Figure 17. Over Temperature OIP3 vs Frequency

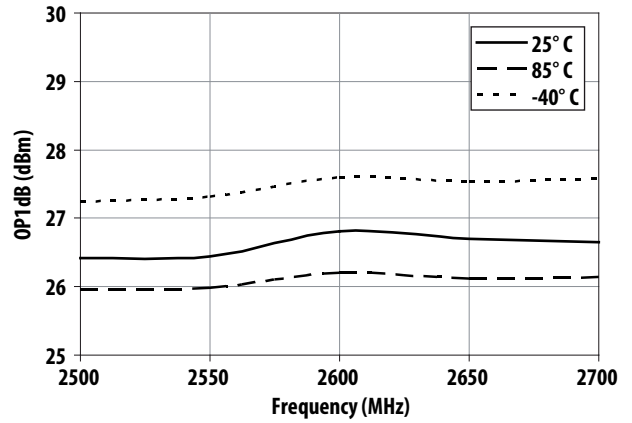

Figure 18. Over Temperature OP1dB vs Frequency

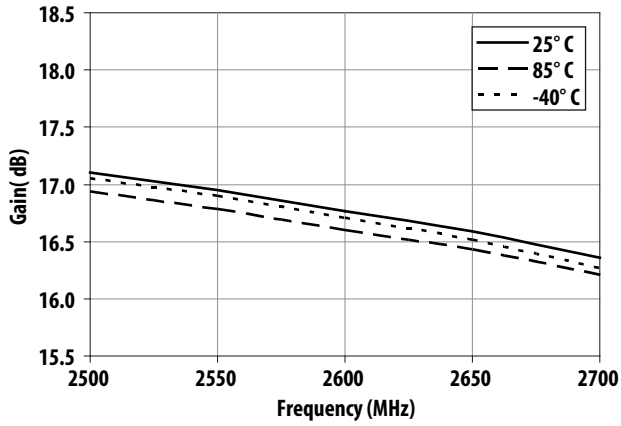

Figure 19. Over Temperature Gain vs Frequency

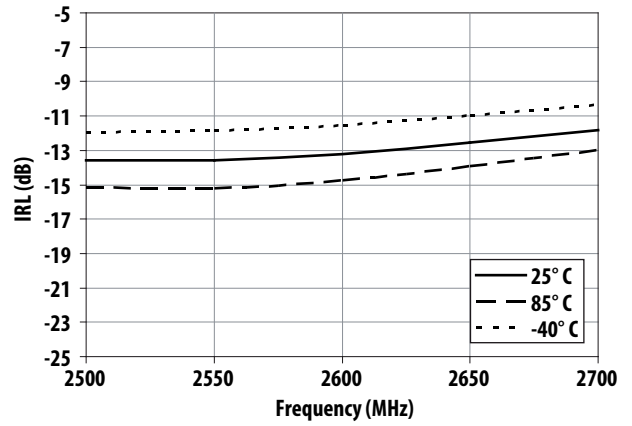

Figure 20. Over Temperature IRL vs Frequency

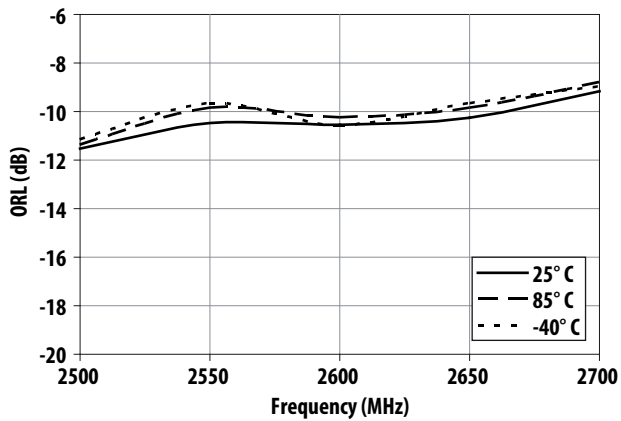

Figure 21. Over Temperature ORL vs Frequency

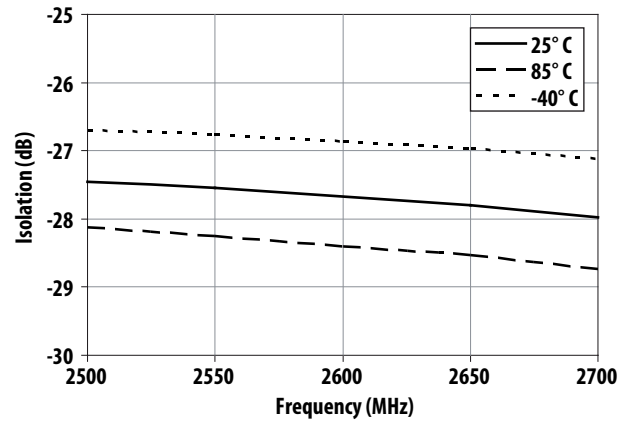

Figure 22. Over Temperature Isolation vs Frequency

MGA-31689 Application Circuit Data for 2600 MHz (continued)

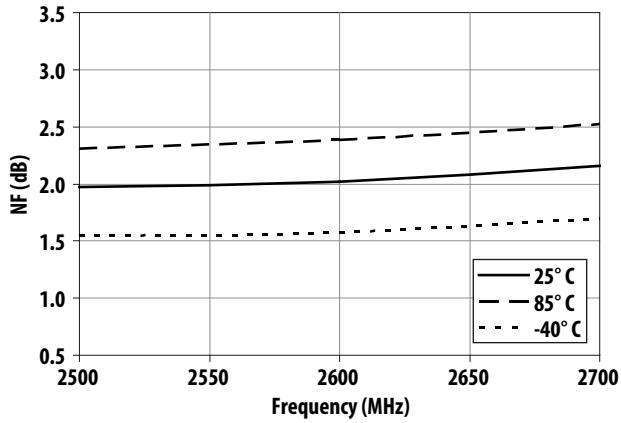

Figure 23. Over Temperature Noise Figure vs Frequency

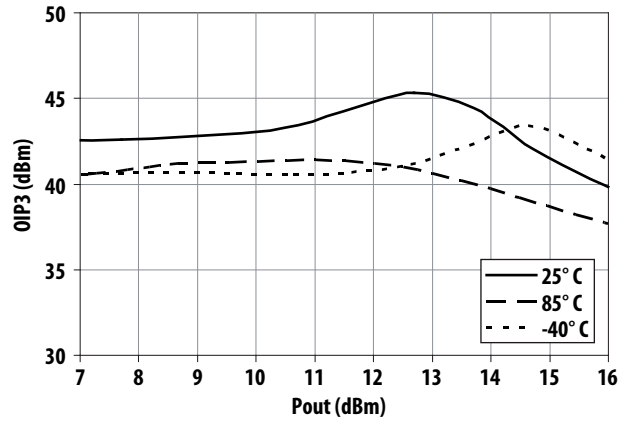

Figure 24. Over Temperature OIP3 vs Pout at 2600 MHz

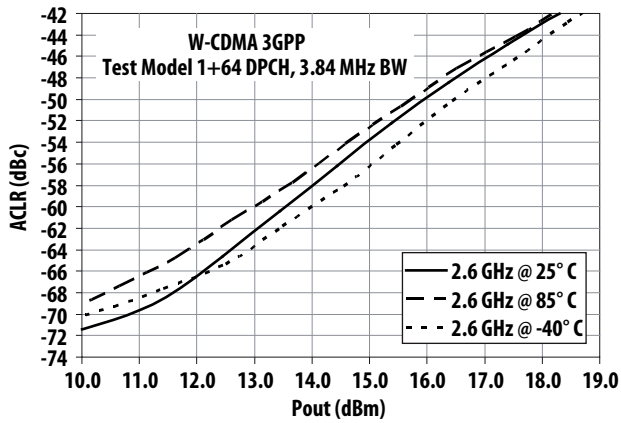

Figure 25. Over Temperature ACLR vs Pout at 2600 MHz

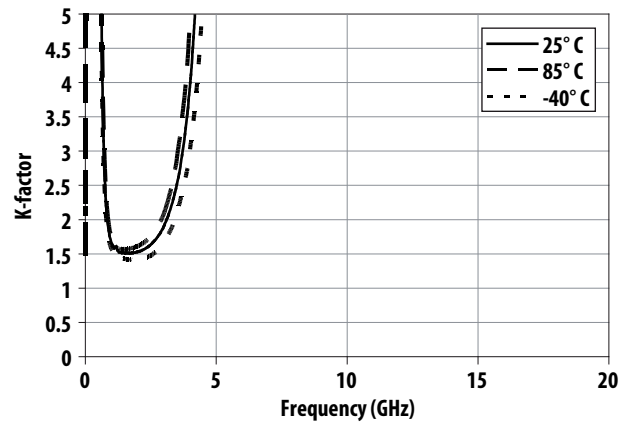

Figure 26. Over Temperature K-factor vs Frequency

Application Circuit Description and Layout

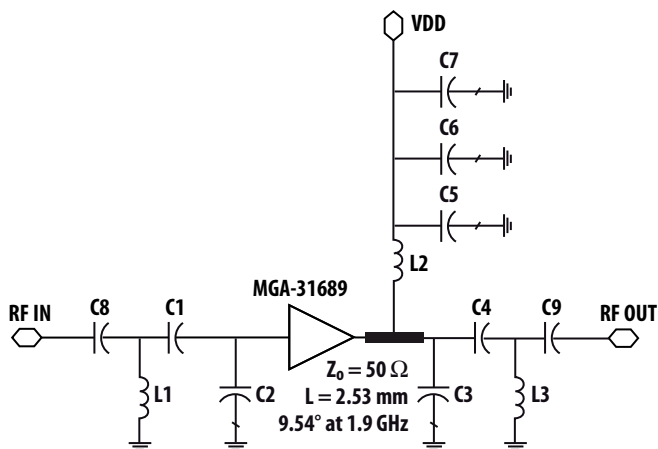

Figure 27. Circuit diagram

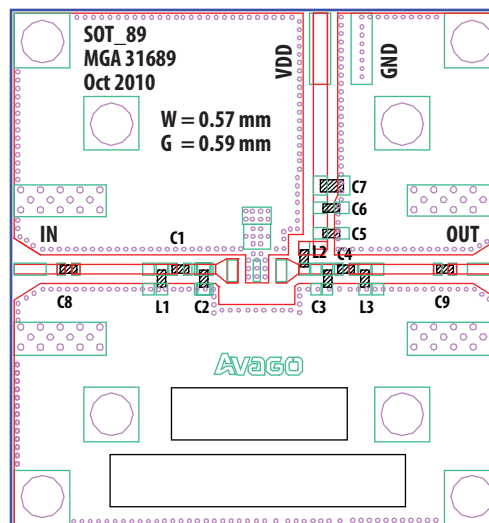

Figure 28. Demo board

Bill of Materials

Circuit Symbol	Size	Description			Description		
		Value	Part Number	Manufacturer	Value	Part Number	Manufacturer
C1	0402	3.0 pF	CM05CH3R0C50AH	Kyocera	5.1 pF	GJM1555C1H5R1DB01E	Murata
C2	0402	2.2 pF	CM05CH2R2C50AH	Kyocera	1.6 pF	CM05CH1R6C50AH	Kyocera
C3	0402	1.8 pF	CM05CH1R8C50AH	Kyocera	1.3 pF	GJM1555C1H1R3CB01E	Murata
C4	0402	3.0 pF	CM05CH3R0C50AH	Kyocera	3.3 pF	CM05CH3R3C50AH	Kyocera
C5	0402	20 pF	GJM1555C1H200JB01D	Murata	20 pF	GJM1555C1H200JB01D	Murata
C6	0402	0.1 μF	GRM155R71C104KA88D	Murata	0.1 μF	GRM155R71C104KA88D	Murata
C7	0805	2.2 μF	GRM21BR61A225KA01L	Murata	2.2 μF	GRM21BR61A225KA01L	Murata
C8*	0402	10 pF	GJM1555C1H100JB01D	Murata	10 pF	GJM1555C1H100JB01D	Murata
C9*	0402	10 pF	GJM1555C1H100JB01D	Murata	10 pF	GJM1555C1H100JB01D	Murata
L1	0402	4.7 nH	LLP1005-FH4N7C	Toko	4.7 nH	LLP1005-FH4N7C	Toko
L2**	0402	12 nH	LL1005-FHL12NJ	Toko	18 nH	0603CS-18NXJLW	Coilcraft
L3	0402	3.9 nH	LLP1005-FH3N9C	Toko	4.7 nH	LLP1005-FH4N7C	Toko

Notes:

* As blocking capacitor, not required in actual application circuit.

** For 2.5 – 2.7 GHz, the component size for L2 is 0603.

For best performance, MGA-31689 requires only simple input and output matching network. The C3, C4, and L3 act as the output tuning circuitry for matching and OIP3 optimization. Bandpass network C1, C2, and L1 forms the input matching network. To bias MGA-31689, a +5 V supply (Vdd) is connected to the output pin thru a RF choke, L2 (which isolates the inband signal from the DC supply). The low frequency bypass capacitor C6 and C7 helps to eliminate out low frequency signals from power supply. Blocking capacitors are required for its input (C8) and output (C9), to isolate the supply voltage from succeeding circuits. The recommended output tuning is for achieving wideband best OIP3, while meeting typical specifications for other parameters.

MGA-31689 Typical Scatter Parameters [1]

$T_A = 25^\circ\text{C}$, $V_{dd} = 5.0\text{V}$, $I_{dd} = 168\text{mA}$, $Z_o = 50\ \Omega$

Freq (GHz)	S11 (dB)	S11 (ang)	S21 (dB)	S21 (ang)	S12 (dB)	S12 (ang)	S22 (dB)	S22 (ang)	k
0.1	-1.73	-176.29	19.41	135.64	-34.95	5.14	-4.23	-174.40	1.029
0.2	-1.60	178.23	16.49	141.07	-35.14	-0.95	-4.66	172.00	1.346
0.3	-1.55	174.62	15.27	143.40	-35.75	-2.88	-5.80	165.82	1.618
0.4	-1.50	171.32	14.55	145.29	-36.43	-0.20	-6.98	167.49	1.855
0.5	-1.52	168.20	14.40	146.24	-36.57	5.31	-7.22	175.57	1.933
0.6	-1.58	165.25	14.62	145.18	-36.05	10.02	-6.26	179.96	1.814
0.7	-1.65	162.49	14.90	141.90	-35.29	11.91	-5.22	178.37	1.655
0.8	-1.72	159.87	15.10	137.34	-34.59	11.60	-4.50	173.97	1.536
0.9	-1.79	157.31	15.19	132.24	-34.01	10.31	-4.08	168.71	1.463
1.0	-1.89	154.32	15.34	126.71	-33.44	8.33	-3.94	163.07	1.418
1.5	-2.17	141.02	15.11	101.04	-31.83	-2.42	-4.15	138.15	1.386
2.0	-2.41	128.13	14.75	77.42	-30.87	-14.23	-5.10	116.88	1.440
2.5	-2.69	115.39	14.53	53.86	-30.25	-28.05	-6.72	96.12	1.529
3.0	-3.03	103.52	14.42	29.25	-30.06	-44.01	-9.50	75.25	1.662
3.5	-3.39	93.23	14.35	2.74	-30.52	-61.83	-15.50	57.72	1.871
4.0	-3.67	84.13	14.12	-26.21	-32.05	-80.46	-23.80	158.07	2.262
4.5	-3.65	74.49	13.50	-57.21	-35.42	-94.95	-10.76	161.61	3.117
5.0	-3.11	67.17	12.26	-87.21	-40.85	-79.96	-6.03	138.92	4.832
5.5	-2.55	52.06	10.64	-117.67	-38.54	-40.42	-3.77	111.77	2.841
6.0	-2.04	35.42	8.58	-146.15	-34.15	-43.36	-2.55	85.59	1.221
6.5	-1.65	19.73	6.24	-171.85	-31.76	-57.66	-1.88	61.65	0.639
7.0	-1.41	5.70	3.84	165.22	-30.44	-73.21	-1.53	40.17	0.409
7.5	-1.29	-8.07	1.51	144.01	-29.63	-88.71	-1.34	20.48	0.350
8.0	-1.26	-22.64	-0.84	123.57	-29.21	-104.42	-1.24	1.84	0.435
8.5	-1.20	-38.39	-3.30	103.77	-29.15	-120.34	-1.20	-15.58	0.624
9.0	-1.10	-53.40	-5.95	85.47	-29.44	-135.19	-1.15	-31.33	0.904
9.5	-0.96	-65.64	-8.67	69.50	-29.93	-148.24	-1.09	-45.13	1.216
10.0	-0.85	-74.87	-11.29	55.67	-30.40	-159.70	-1.03	-57.60	1.581
10.5	-0.81	-82.71	-13.76	42.92	-30.75	-170.49	-1.00	-69.49	2.189
11.0	-0.79	-90.85	-16.17	30.60	-31.05	178.21	-0.99	-81.33	3.145
11.5	-0.79	-100.10	-18.70	18.42	-31.52	166.73	-0.98	-93.00	4.686
12.0	-0.75	-109.77	-21.50	7.20	-32.09	155.73	-0.94	-103.75	6.618
12.5	-0.70	-118.76	-24.60	-2.08	-32.83	145.29	-0.87	-112.91	9.242
13.0	-0.64	-126.30	-27.95	-8.47	-33.59	136.46	-0.80	-120.17	13.003
13.5	-0.62	-133.09	-31.61	-11.77	-34.26	128.95	-0.75	-126.39	19.930
14.0	-0.64	-140.44	-35.69	-9.45	-34.65	120.99	-0.76	-132.81	35.210
14.5	-0.66	-149.01	-39.92	4.91	-34.91	112.42	-0.81	-140.46	65.138
15.0	-0.66	-158.40	-41.70	37.45	-35.05	103.83	-0.86	-149.34	86.470
15.5	-0.62	-166.86	-39.37	61.97	-34.99	96.58	-0.89	-158.78	64.814
16.0	-0.57	-173.43	-36.28	68.60	-34.52	89.89	-0.94	-167.95	42.097
16.5	-0.56	-178.29	-33.36	65.78	-33.43	81.69	-0.88	-176.61	24.984
17.0	-0.60	176.64	-31.15	57.85	-32.44	71.56	-0.89	174.74	18.590
17.5	-0.71	169.61	-29.31	49.07	-31.42	62.09	-0.94	165.95	16.390
18.0	-0.82	159.90	-27.65	39.55	-30.24	52.70	-1.02	156.90	14.673
18.5	-0.90	148.46	-26.20	29.22	-29.05	42.85	-1.09	148.57	12.648
19.0	-0.88	137.36	-25.07	18.00	-28.07	31.79	-1.14	140.81	10.113
19.5	-0.85	129.30	-24.17	9.00	-27.18	23.70	-1.21	134.72	8.495
20.0	-0.89	123.82	-23.25	1.71	-26.14	17.14	-1.45	130.08	8.192

MGA-31689 Typical Noise Parameters [1]

$T_A = 25^\circ \text{C}$, $V_{dd} = 5.0 \text{ V}$, $I_{dd} = 168 \text{ mA}$, $Z_o = 50 \Omega$

Freq (GHz)	F_{min} (dB)	Γ_{opt} Mag	Γ_{opt} Ang	R_n/Z_o	Ga (dB)
0.50	4.43	0.83	-168.90	0.14	19.94
0.80	3.72	0.787	-160.90	0.17	20.53
0.90	3.49	0.776	-159.50	0.15	20.50
1.00	3.20	0.763	-153.50	0.14	20.50
1.50	2.45	0.726	-138.50	0.24	19.74
2.00	1.95	0.693	-126.20	0.22	18.81
2.50	1.30	0.656	-114.50	0.27	18.09
3.00	1.11	0.636	-104.50	0.27	17.43
3.50	1.08	0.586	-96.10	0.40	16.96
4.00	1.60	0.55	-89.50	0.50	16.56
4.50	2.34	0.517	-70.80	0.77	16.32
5.00	3.50	0.472	-56.60	1.20	15.99
5.50	5.06	0.447	-22.80	1.80	14.99
6.00	7.03	0.411	-17.02	2.60	14.68

Note:

1. Measurements are made using 10 mils Rogers RO4350 TRL Board.

Package Dimensions

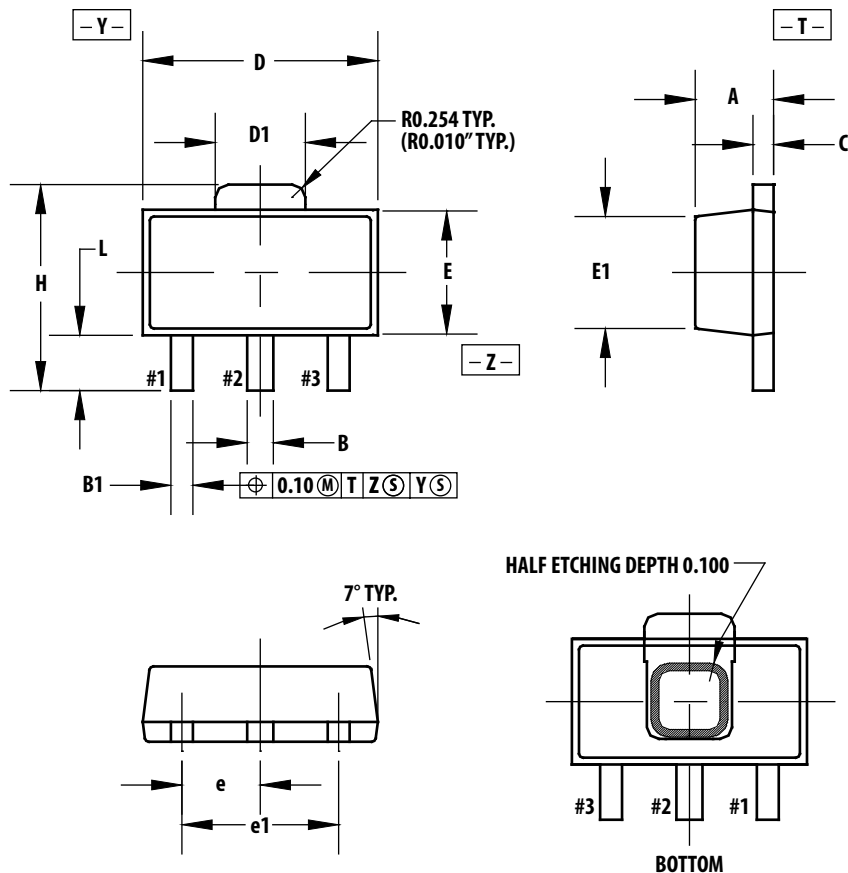

	COMMON					
	DIMENSIONS MILLIMETER			DIMENSIONS INCH		
	MIN.	NOM.	MAX.	MIN.	NOM.	MAX.
A	1.40	1.50	1.60	0.055	0.059	0.063
B	0.44	0.50	0.56	0.017	0.0195	0.022
B1	0.36	0.42	0.48	0.014	0.0165	0.019
C	0.35	0.40	0.44	0.014	0.016	0.017
D	4.40	4.50	4.60	0.173	0.177	0.181
D1	1.62	1.73	1.83	0.064	0.068	0.072
E	2.30	2.50	2.60	0.090	0.096	0.102
E1	2.13	2.20	2.29	0.084	0.087	0.090
e	1.50 BSC			0.059 BSC		
e1	3.00 BSC			0.118 BSC		
H	3.95	4.10	4.25	0.155	0.161	0.167
L	0.90	1.10	1.20	0.035	0.038	0.047

Note:

- Dimensioning and tolerancing per ANSI.Y14.5M-1982
- Controlling dimension: Millimeter conversions to inches are not necessarily exact
- Dimension B1, 2 places.
- Lead co-planarity control below 4 mils.

Part Number Ordering Information

Part Number	No. of Devices	Container
MGA-31689-BLKG	100	Antistatic Bag
MGA-31689-TR1G	3000	13" Tape/Reel

Device Orientation

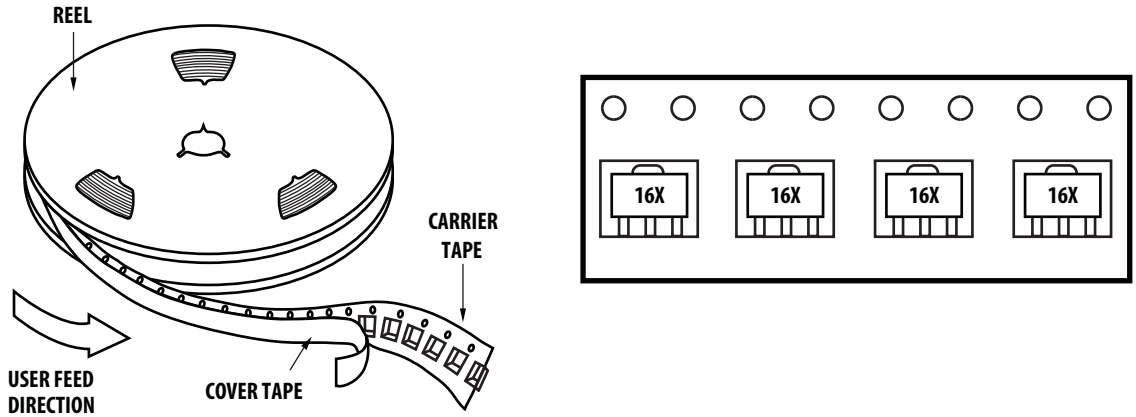

Tape Dimensions

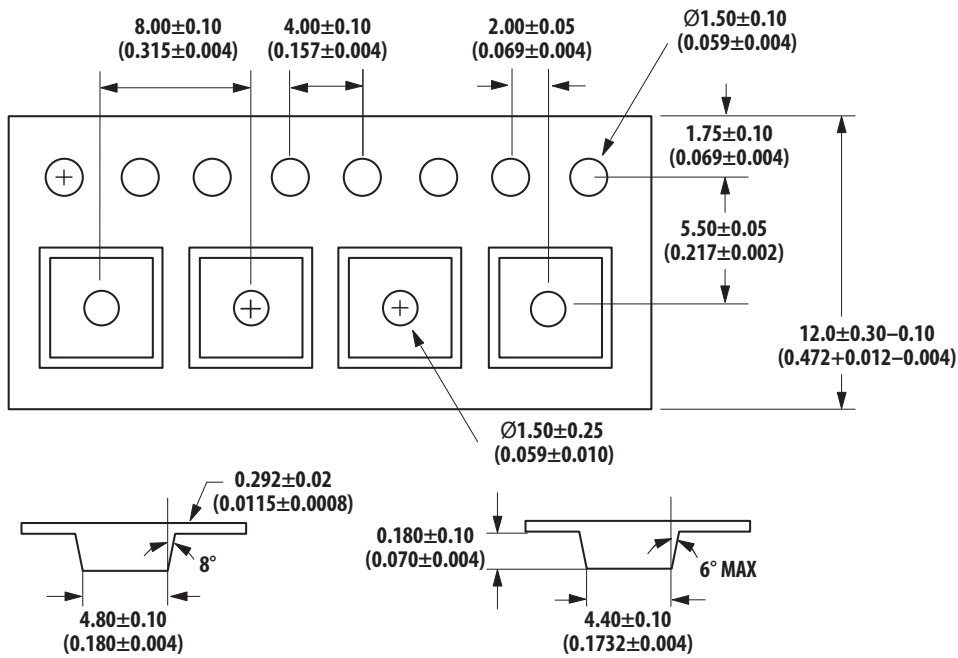

Dimensions in mm (inches)

Reel Dimension – 13" Reel 12mm Width

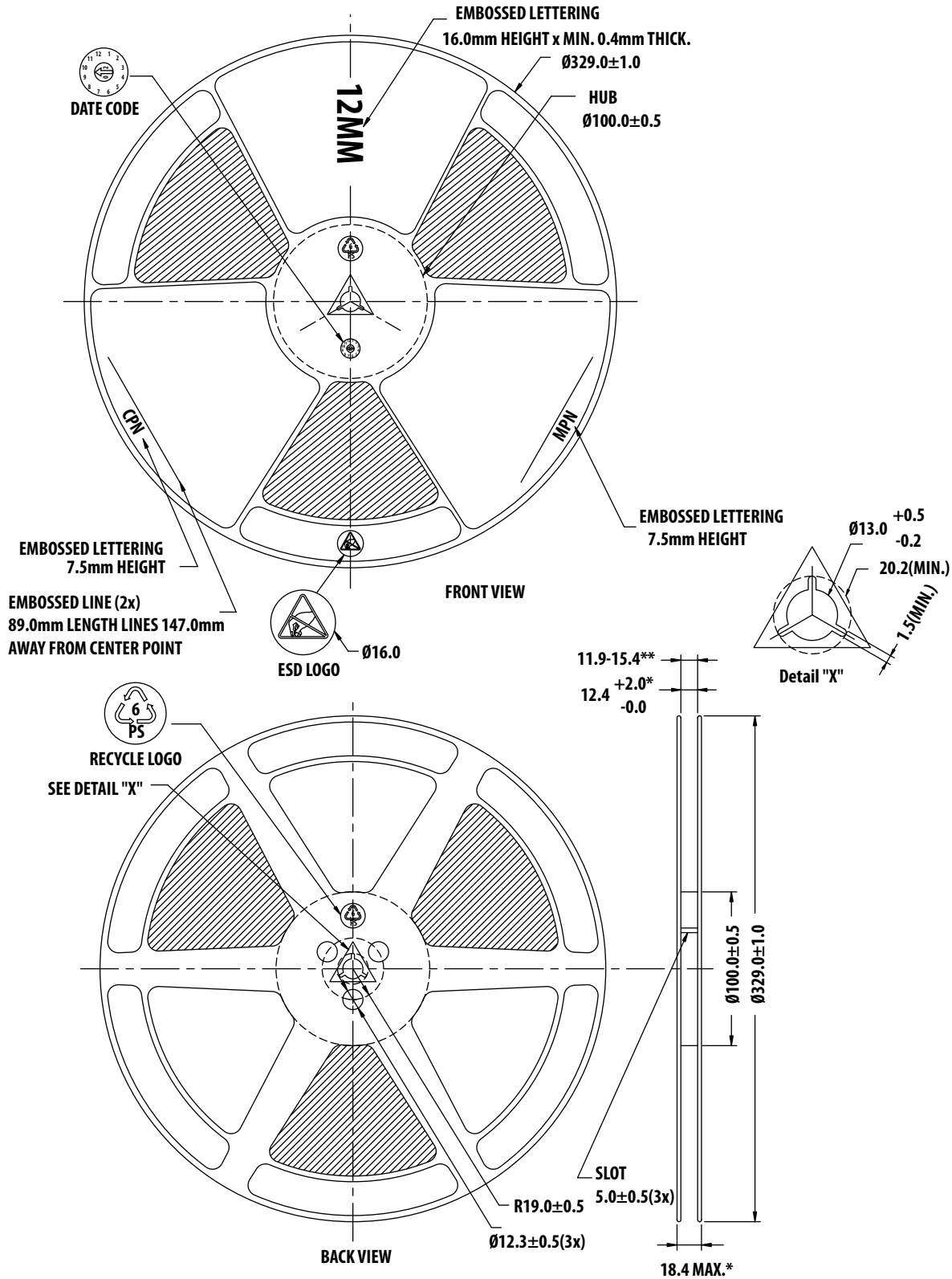

For product information and a complete list of distributors, please go to our web site: www.avagotech.com

Avago, Avago Technologies, and the A logo are trademarks of Avago Technologies in the United States and other countries. Data subject to change. Copyright © 2005-2010 Avago Technologies. All rights reserved. AV02-2745EN - December 8, 2010

