

MGA-43040

High Linearity (2.3 – 2.4) GHz Power Amplifier Module



Data Sheet

Description

Avago Technologies' MGA-43040 is a fully matched power amplifier for use in the (2.3 – 2.4) GHz band. High linear output power at 5V is achieved through the use of Avago Technologies' proprietary 0.25 μm GaAs Enhancement-mode pHEMT process. MGA-43040 is housed in a miniature 5.0 mm \times 5.0 mm molded-chip-on-board (MCOB) module package. A detector is also included on-chip. The compact footprint coupled with high gain, high linearity and good efficiency makes the MGA-43040 an ideal choice as a power amplifier for small cell BTS PA applications.

Applications

- Final stage high linearity amplifier for Picocell and Enterprise Femtocell PA targeted for small cell BTS downlink applications.

Component Image

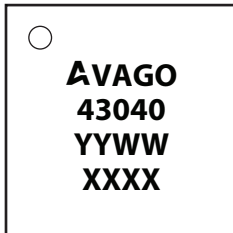

(5.0 \times 5.0 \times 0.9) mm Package Outline

Notes:
 Package marking provides orientation and identification
 "43040" = Tentative device part number
 "YYWW" = Year and work week
 "XXXX" = Assembly lot number

TOP VIEW

Pin Configuration

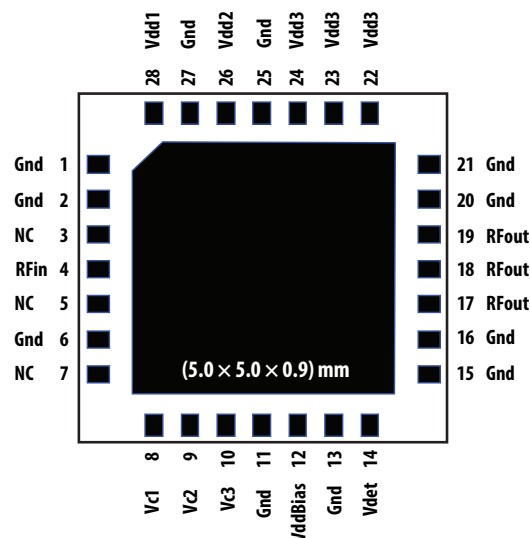

Features

- High linearity performance: Typ -48dBc ACPR1 [1] at 27.0 dBm linear output power (biased with 5V supply)
- High Gain : 40 dB
- Good efficiency
- Fully matched
- Built-in detector
- GaAs E-pHEMT Technology [2]
- Low cost small package size: (5.0 \times 5.0 \times 0.9) mm

Specifications

- 2.35 GHz; 5.0 V, I_{dq_total} = 340 mA (typ), LTE 20 MHz 100 RB
- PAE: 13%
- 27.0 dBm linear P_{out} @ ACPR1 = -48 dBc [1]
- 40 dB Gain
- Detector range: 20 dB

Notes:

- LTE 20 MHz 100 RB Test Mode 1.1 downlink signal
- Enhancement mode technology employs positive V_{GS} , and so eliminates the need for negative gate voltage associated with conventional depletion mode devices

Functional Block Diagram

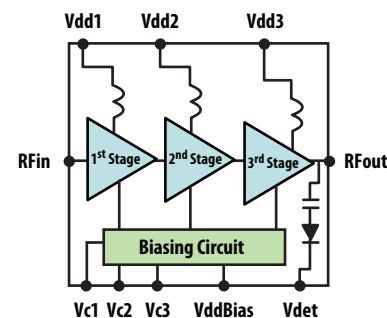

Attention: Observe precautions for handling electrostatic sensitive devices.

ESD Machine Model = 70 V
 ESD Human Body Model = 350 V
 Refer to Avago Application Note A004R:
 Electrostatic Discharge, Damage and Control.

Absolute Maximum Rating^[1] T_A = 25 °C

Symbol	Parameter	Units	Absolute Max.
Vdd, VddBias	Supply voltages, bias supply voltage	V	6
Vc	Control Voltage	V	(Vdd)
P _{in,max}	CW RF Input Power	dBm	20
P _{diss}	Total Power Dissipation ^[3]	W	5.3
T _j	Junction Temperature	°C	150
T _{STG}	Storage Temperature	°C	-65 to 150

Thermal Resistance^[2,3]

$$\theta_{jc} = 14.2 \text{ } ^\circ\text{C/W}$$

Notes:

1. Operation of this device in excess of any of these limits may cause permanent damage.
2. Thermal resistance measured using Infra-Red Measurement Technique.
3. Board temperature (T_B) is 25 °C, for T_B > 74.7 °C derate the device power at 70.4 mW per °C rise in Board (package belly) temperature.

Electrical Specifications

T_A = 25 °C, Vdd1,2,3 = Vddbias=5.0 V, Idqtotal = 350 mA, RF performance at 2.35 GHz, unless otherwise stated.

Symbol	Parameter and Test Condition	Units	Min.	Typ.	Max.
Vdd	Supply Voltage	V		5.0	
Idq_total	Quiescent Supply Current	mA		340	
Gain	Gain	dB	35	40	
OP1dB	Output Power at 1dB Gain Compression	dBm		35	
ACPR1 @ P _{out} =27.0 dBm	LTE 20 MHz 100 RB Test Mode 1.1 downlink signal	dBc		-48	-45
PAE	Power Added Efficiency	%		13	
S11	Input Return Loss, 50 Ω source	dB		20	
DetR	Detector RF dynamic range	dB		20	
2fo	2fo Harmonics	dBc		-27	

Product Consistency Distribution Charts^[4]

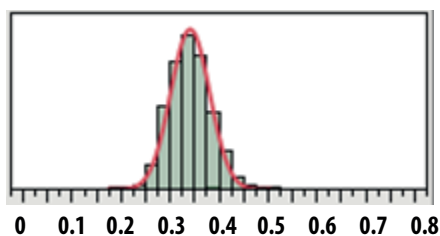

Figure 1. Idq_total, Nominal = 340mA

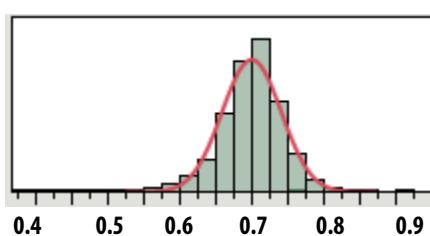

Figure 2. Idd_total at Pout=27.0dBm, Nominal = 700mA

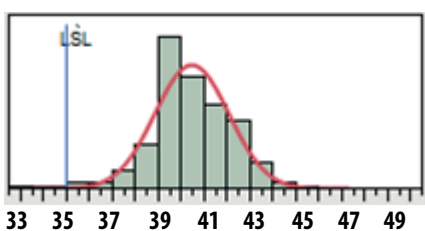

Figure 3. Gain at Pout=27.0dBm, LSL= 35dB, Nominal = 40dB

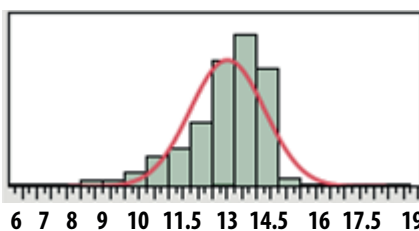

Figure 4. PAE at Pout=27.0dBm, Nominal = 13%

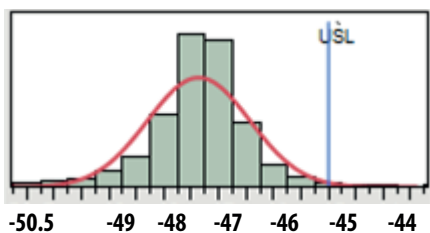

Figure 5. ACPR1 at Pout=27.0dBm, USL= -45dBc, Nominal = -47.7dBc

Note:

4. Distribution data sample size is 1500 samples taken from 3 different wafer lots. T_A=25°C, Vdd=VddBias=5.0V, Vc1=2.0V, Vc2=1.8V, Vc3=1.8V, RF performance at 2.35 GHz unless otherwise stated. Future wafers allocated to this product may have nominal values anywhere between the upper and lower limits.

Application Schematic

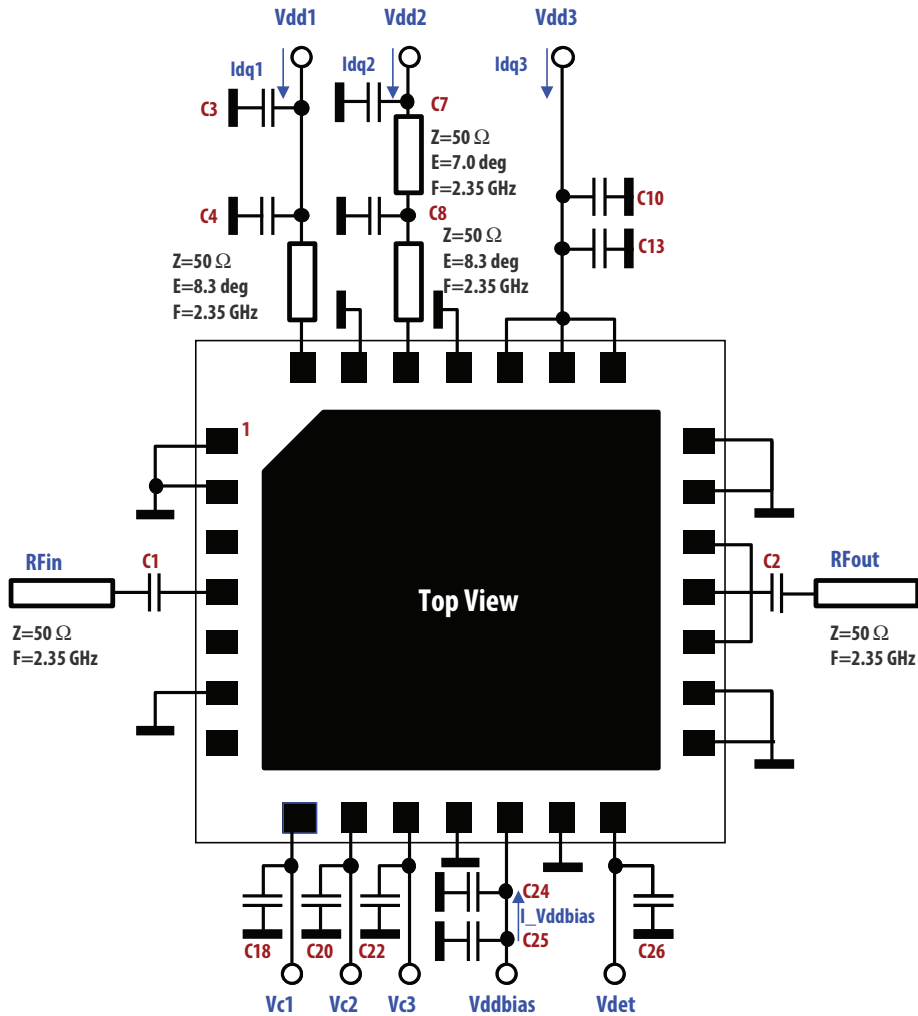
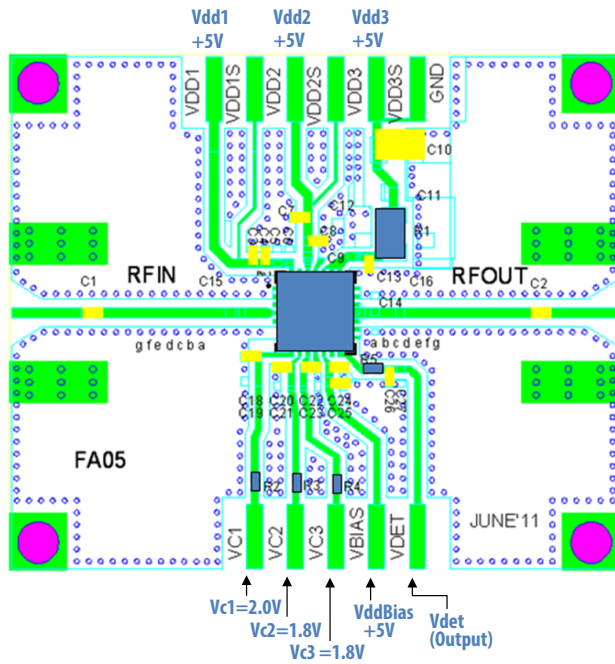

Figure 6. Application circuit in demonstration board

Notes

1. All capacitors on supply lines are bypass capacitors.
2. C1/C2 are RF coupling capacitors.
3. Idq1= 60 mA, Idq2 = 110 mA, Idq3 = 180.0 mA, I_Vddbias = 16.0 mA at Vdd1,2,3=VddBias=5.0 V. Idq1/2/3 are adjusted by voltages to CMOS-compatible control pins Vc1/2/3, respectively. These typical bias currents were obtained with Vc1/2/3 voltages in Figure 2. Adjustment of these currents enable optimum bias conditions to be achieved for best linearity and efficiency for a given modulation type.

Demonstration Board Top View



Component	Value	Part Number	Size
C1, C2, C18, C20, C22	7.5 pF ± 0.5 pF	GJM1555C1H7R5DB01D	0402
C24	6.0 pF ± 0.5 pF	GJM1555C1H6R0DB01D	0402
C4, C8	8.2 pF ± 0.25 pF	GJM1555C1H8R2WB01D	0402
C3, C7, C13, C25	0.1 μF ± 10%	GRM155R71C104KA88D	0402
C10	2.2 μF ± 10%	GRM21BR61E225KA12L	0805
C26	22 nF ± 10%	CM05X7R223K16AHF	0402
R2, R3, R4, R5	0 Ω	RMC1/16S JPTH	0402
R1	0 Ω	RMC1/10 JPTP	0805

Figure 7. Demonstration board application circuit for MGA-43040 module

MGA-43040 typical over-temperature performance at $V_{c1}=2.0\text{ V}$, $V_{c2}=1.8\text{ V}$, $V_{c3}=1.8\text{ V}$ as shown in Figure 2, unless otherwise stated

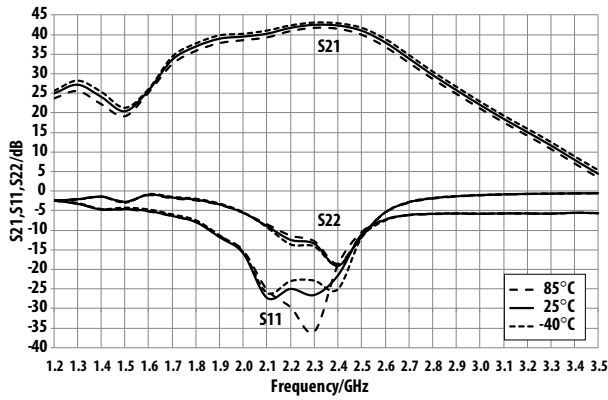

Figure 8. Small-signal performance Over-temperature
 $V_{dd}=V_{ddBias}=5.0\text{ V}$ operating voltage

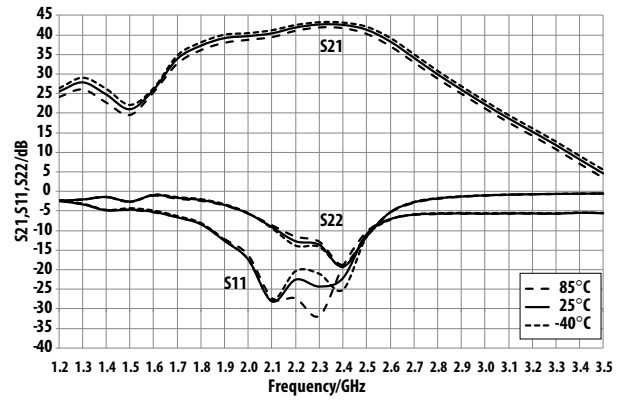

Figure 9. Small-signal performance Over-temperature
 $V_{dd}=V_{ddBias}=5.5\text{ V}$ operating voltage

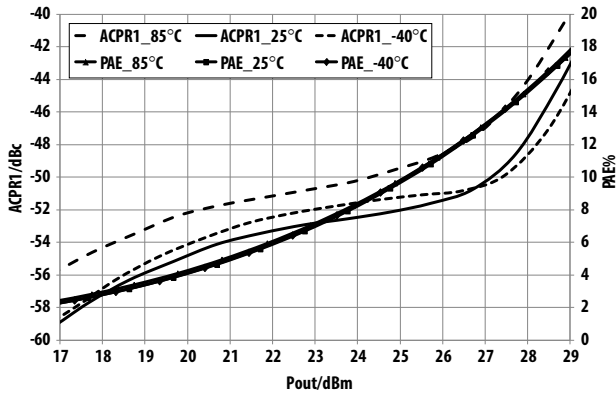

Figure 10. Over-temperature ACPR1, PAE vs. P_{out} @ 2.33 GHz
 $V_{dd}=V_{ddBias}=5.0\text{ V}$ operating voltage

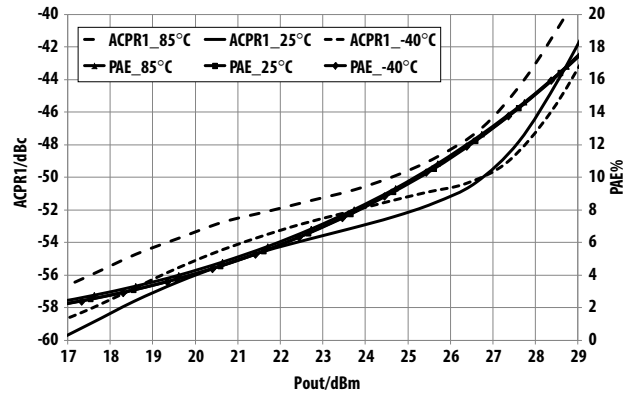

Figure 11. Over-temperature ACPR1, PAE vs. P_{out} @ 2.35 GHz
 $V_{dd}=V_{ddBias}=5.0\text{ V}$ operating voltage

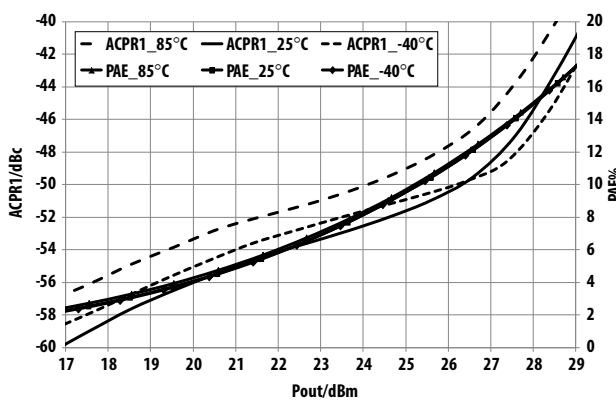

Figure 12. Over-temperature ACPR1, PAE vs. P_{out} @ 2.36 GHz
 $V_{dd}=V_{ddBias}=5.0\text{ V}$ operating voltage

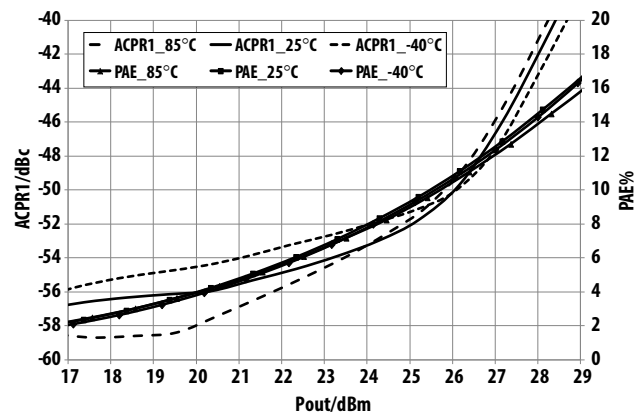

Figure 13. Over-temperature ACPR1, PAE vs. P_{out} @ 2.39 GHz
 $V_{dd}=V_{ddBias}=5.0\text{ V}$ operating voltage

MGA-43040 typical over-temperature performance at $V_{c1}=2.0\text{ V}$, $V_{c2}=1.8\text{ V}$, $V_{c3}=1.8\text{ V}$ as shown in Figure 2, unless otherwise stated (Cont.)

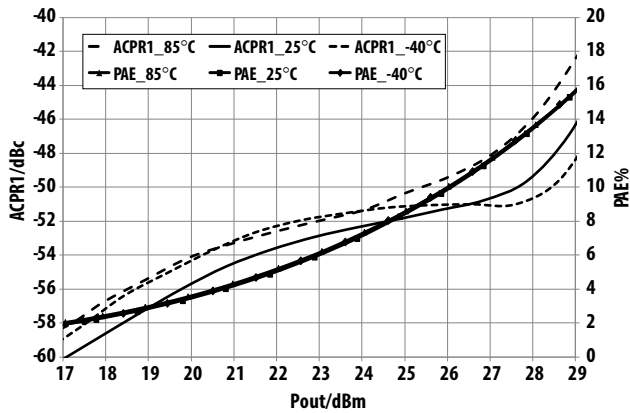

Figure 14. Over-temperature ACPR1, PAE vs. P_{out} @ 2.33 GHz
 $V_{dd}=V_{ddBias}=5.5\text{ V}$ operating voltage

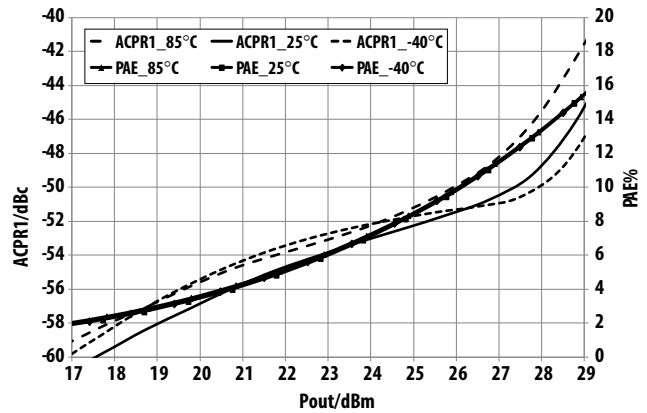

Figure 15. Over-temperature ACPR1, PAE vs. P_{out} @ 2.35 GHz
 $V_{dd}=V_{ddBias}=5.5\text{ V}$ operating voltage

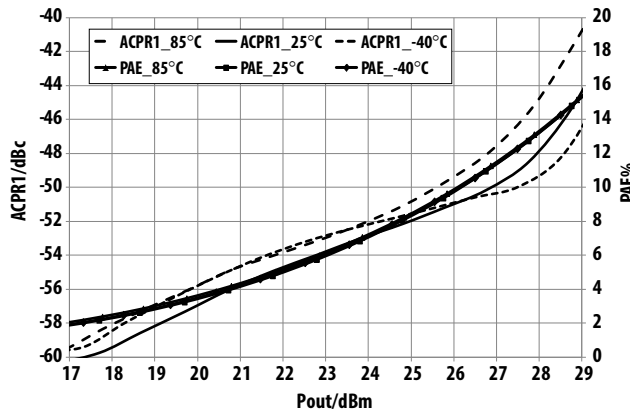

Figure 16. Over-temperature ACPR1, PAE vs. P_{out} @ 2.36 GHz
 $V_{dd}=V_{ddBias}=5.5\text{ V}$ operating voltage

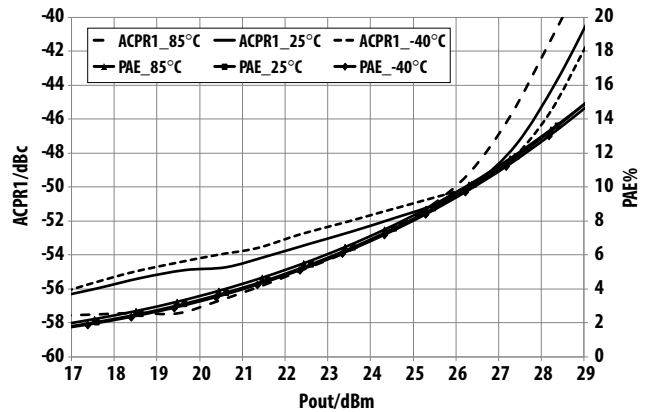

Figure 17. Over-temperature ACPR1, PAE vs. P_{out} @ 2.39 GHz
 $V_{dd}=V_{ddBias}=5.5\text{ V}$ operating voltage

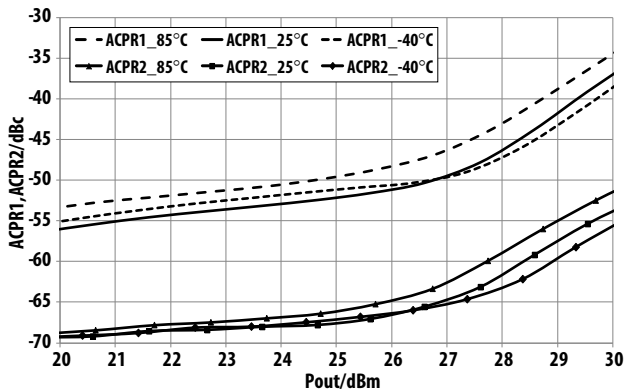

Figure 18. Over-temperature ACPR1, ACPR2 vs. P_{out} @ 2.35 GHz
 $V_{dd}=V_{ddBias}=5.5\text{ V}$ operating voltage

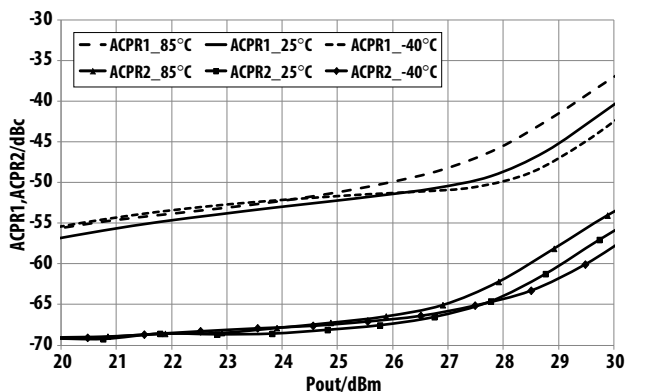

Figure 19. Over-temperature ACPR1, ACPR2 vs. P_{out} @ 2.35 GHz
 $V_{dd}=V_{ddBias}=5.5\text{ V}$ operating voltage

MGA-43040 typical over-temperature performance at $V_{c1}=2.0\text{ V}$, $V_{c2}=1.8\text{ V}$, $V_{c3}=1.8\text{ V}$ as shown in Figure 2, unless otherwise stated (Cont.)

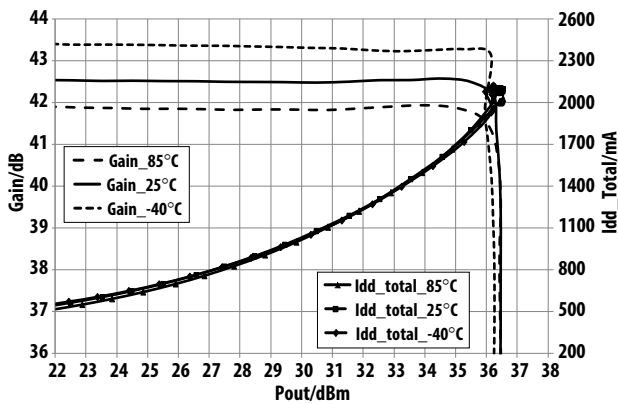

Figure 20. Over-temperature Gain, I_{dd_total} vs. P_{out} @ 2.33GHz
 $V_{dd}=V_{ddBias}=5.0\text{ V}$ operating voltage

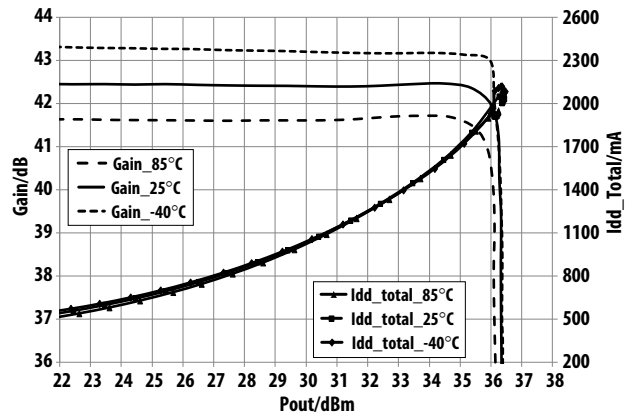

Figure 21. Over-temperature Gain, I_{dd_total} vs. P_{out} @ 2.35 GHz
 $V_{dd}=V_{ddBias}=5.0\text{ V}$ operating voltage

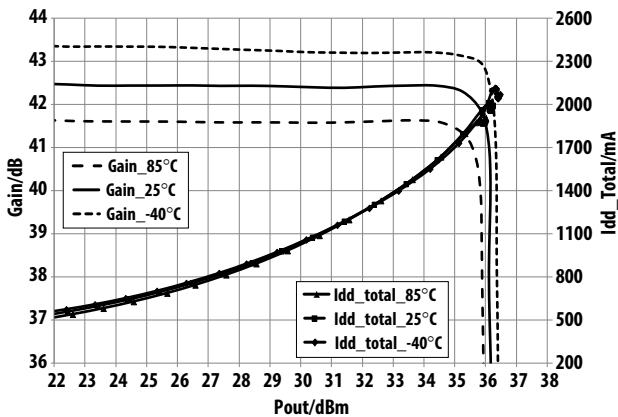

Figure 22. Over-temperature Gain, I_{dd_total} vs. P_{out} @ 2.36GHz
 $V_{dd}=V_{ddBias}=5.0\text{ V}$ operating voltage

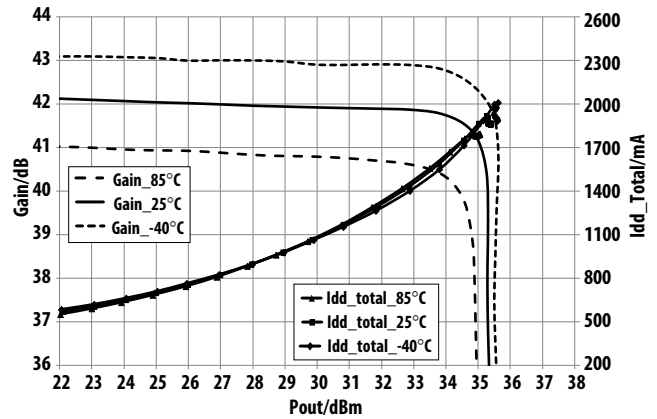

Figure 23. Over-temperature Gain, I_{dd_total} vs. P_{out} @ 2.39GHz
 $V_{dd}=V_{ddBias}=5.0\text{ V}$ operating voltage

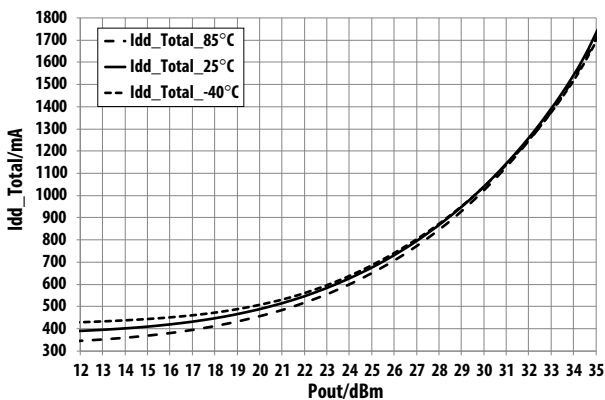

Figure 24. Over-temperature I_{dd_total} vs. P_{out} @ 2.35 GHz
 $V_{dd}=V_{ddBias}=5.0\text{ V}$ operating voltage

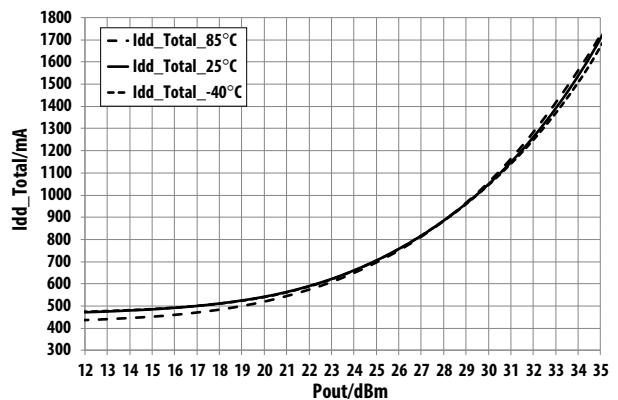

Figure 25. Over-temperature I_{dd_total} vs. P_{out} @ 2.35 GHz
 $V_{dd}=V_{ddBias}=5.5\text{ V}$ operating voltage

MGA-43040 typical over-temperature performance at $V_{C1}=2.0\text{ V}$, $V_{C2}=1.8\text{ V}$, $V_{C3}=1.8\text{ V}$ as shown in Figure 2, unless otherwise stated (Cont.)

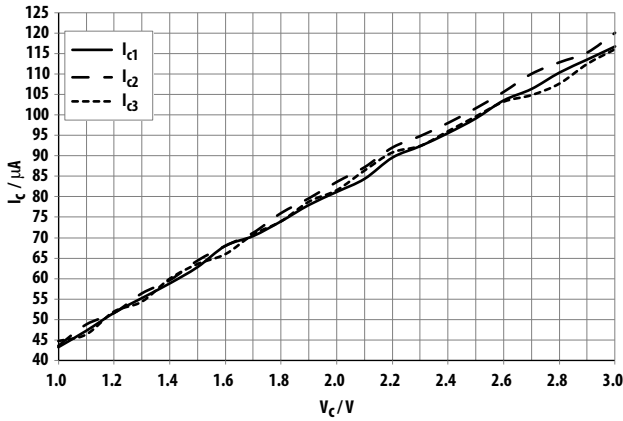

Figure 26. I_C vs. V_C @ $V_{dd}=V_{ddBias}=5.0\text{ V}$

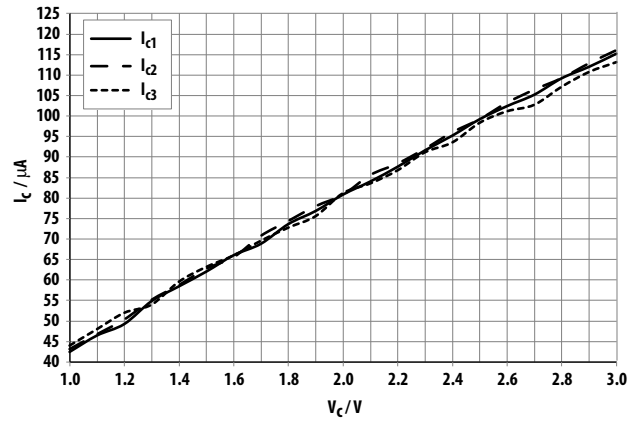

Figure 27. I_C vs. V_C @ $V_{dd}=V_{ddBias}=5.5\text{ V}$

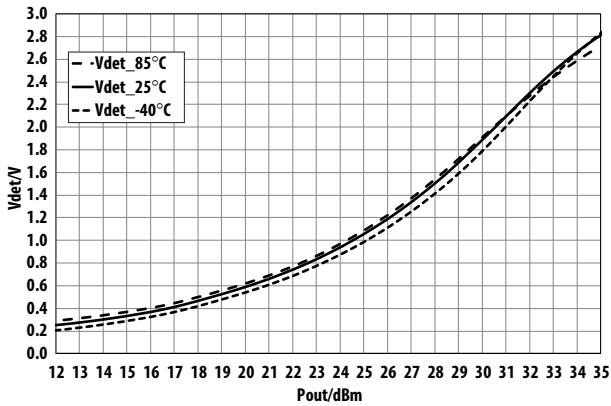

Figure 28. Over-temperature V_{det} vs. P_{out} @ 2.35 GHz $V_{dd}=V_{ddBias}=5.0\text{ V}$ operating voltage

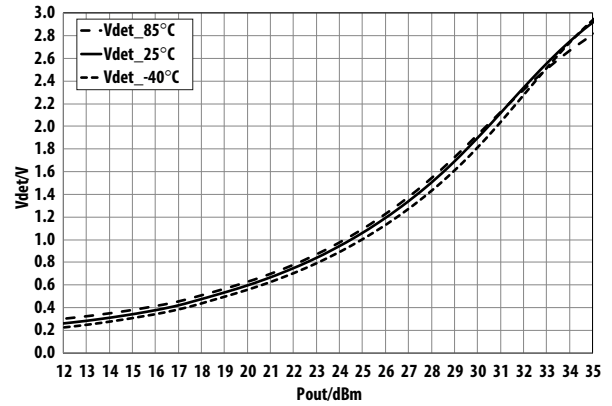

Figure 29. Over-temperature V_{det} vs. P_{out} @ 2.35 GHz $V_{dd}=V_{ddBias}=5.5\text{ V}$ operating voltage

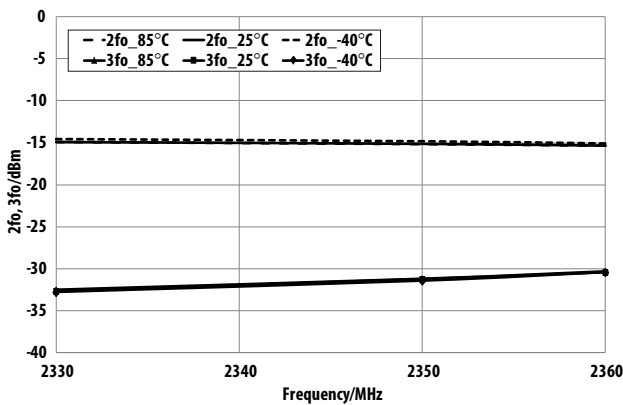

Figure 30. Over-temperature 2nd, 3rd Harmonics vs. Freq at $P_{out}=27.0\text{ dBm}$ $V_{dd}=V_{ddBias}=5.0\text{ V}$ operating voltage

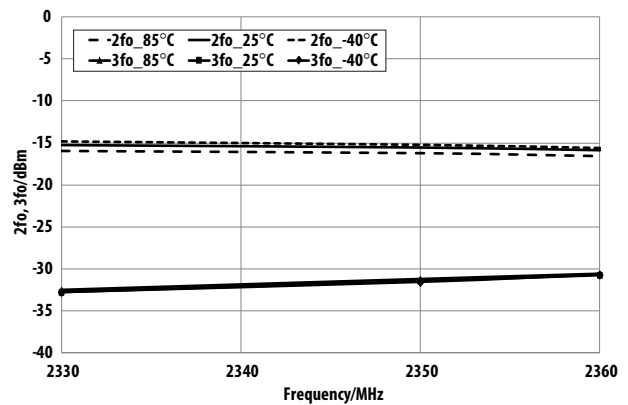

Figure 31. Over-temperature 2nd, 3rd Harmonics vs. Freq at $P_{out}=27.0\text{ dBm}$ $V_{dd}=V_{ddBias}=5.5\text{ V}$ operating voltage

MGA-43040 typical LTE 20MHz 100RB Test model 1.1 downlink signal Spectrum Emission Mask (3GPP TS 36.141v8.2.0 [2009-03] standard) performance at Vdd=VddBias=5.0V, Vc1=2.0V, Vc2=1.8V, Vc3=1.8V, unless otherwise stated

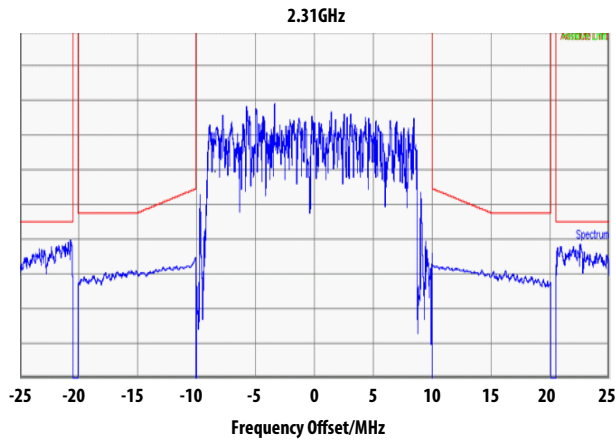

Figure 32. Spectrum Emission Mask 29.0dBm @ 2.31GHz

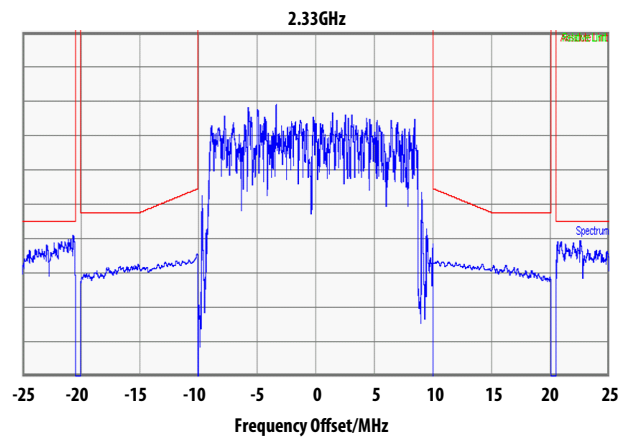

Figure 33. Spectrum Emission Mask 29.0dBm @ 2.33GHz

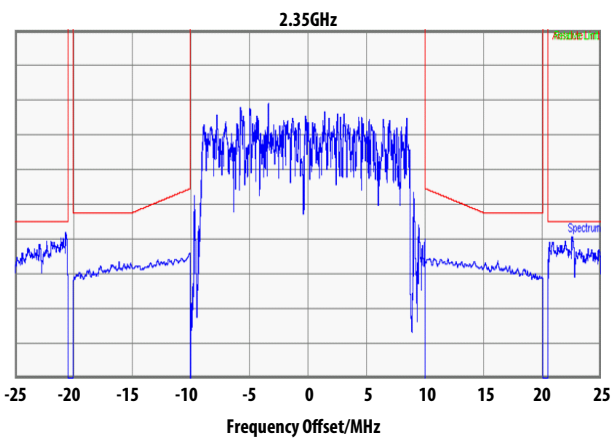

Figure 34. Spectrum Emission Mask 29.0dBm @ 2.35GHz

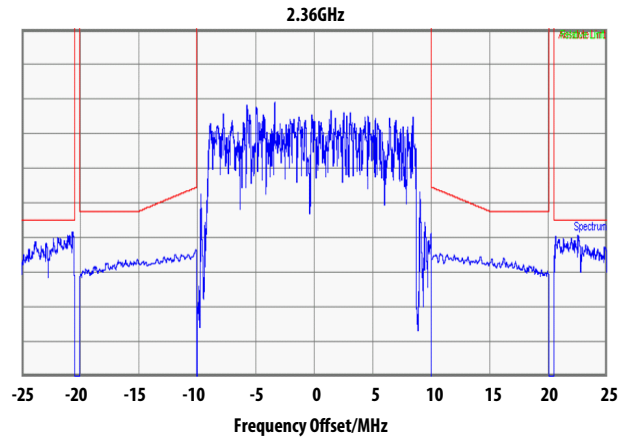

Figure 35. Spectrum Emission Mask 29.0dBm @ 2.36GHz

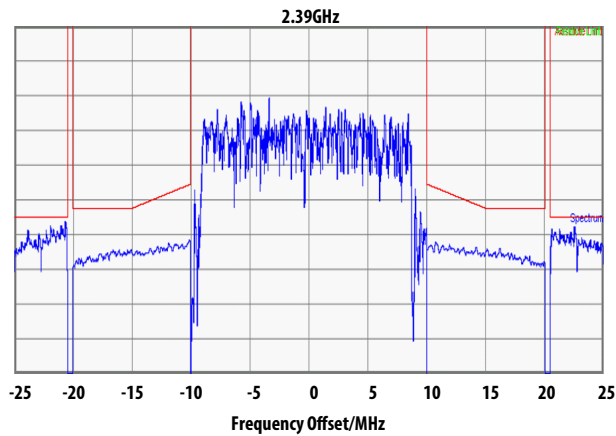

Figure 36. Spectrum Emission Mask 29.0dBm @ 2.39GHz

S-Parameter^[5] (Vdd=VddBias=5.0 V, Vc1=2.0 V, Vc2=1.8 V, Vc3=1.8 V), T=25 °C, 50 Ω matched)

Freq (GHz)	S11 (dB)	S11 (ang)	S21 (dB)	S21 (ang)	S12 (dB)	S12 (ang)	S22 (dB)	S22 (ang)
0.1	-0.05	-43.46	-82.39	-171.41	-67.41	-91.79	-0.30	166.08
0.2	-0.22	-83.93	-60.05	-51.56	-64.37	168.17	-0.87	155.53
0.3	-0.36	-118.96	-53.12	-81.90	-63.68	155.26	-0.98	146.84
0.4	-0.37	-148.39	-45.86	-59.12	-67.47	105.30	-1.01	137.19
0.5	-0.35	-174.08	-31.36	-62.51	-73.24	172.77	-1.02	127.41
0.6	-0.28	163.16	-17.64	-90.87	-65.58	38.34	-1.05	117.77
0.7	-0.17	141.41	-4.02	-130.57	-66.15	61.01	-1.10	108.24
0.8	-0.58	116.96	9.92	158.29	-74.19	2.78	-1.16	98.76
0.9	-1.87	107.86	14.37	53.34	-66.90	15.50	-1.29	89.64
1.0	-1.42	93.88	15.71	-3.31	-63.91	36.37	-1.40	80.96
1.1	-1.30	77.99	18.00	-55.30	-61.66	8.43	-1.51	68.16
1.2	-1.43	61.07	19.49	-111.33	-63.18	-18.31	-1.36	60.32
1.3	-2.07	45.60	16.61	-165.69	-71.45	-87.61	-0.88	50.72
1.4	-2.57	33.09	7.46	-107.91	-68.04	40.18	-0.78	33.71
1.5	-2.53	16.75	22.97	-147.49	-59.29	-49.87	-1.03	35.08
1.6	-3.13	-3.43	26.55	169.35	-63.70	-84.48	-0.79	15.51
1.7	-4.26	-26.39	31.66	131.53	-64.44	-77.11	-1.03	3.68
1.8	-6.46	-54.59	35.65	81.77	-62.93	-76.77	-1.48	-10.92
1.9	-13.31	-95.41	37.67	23.38	-56.37	-66.15	-2.52	-26.00
2.0	-18.65	-1.32	36.26	-14.30	-56.63	-65.83	-4.20	-38.55
2.1	-16.25	-3.09	40.32	-56.14	-53.00	-88.72	-6.67	-43.62
2.2	-13.94	-16.83	41.97	-112.63	-52.08	-126.04	-7.70	-42.86
2.3	-17.96	-14.21	42.23	-169.83	-50.57	-142.00	-9.59	-49.60
2.4	-11.93	24.47	41.55	130.45	-52.68	-173.57	-13.58	-18.72
2.5	-6.32	-3.43	38.86	71.56	-51.37	135.22	-6.49	-0.10
2.6	-4.80	-34.45	34.80	23.16	-53.36	110.86	-3.03	-21.17
2.7	-4.70	-58.87	30.56	-15.19	-56.87	93.98	-1.71	-42.16
2.8	-5.06	-78.96	26.53	-47.47	-61.31	53.15	-1.15	-60.74
2.9	-5.55	-96.34	22.75	-75.99	-60.49	66.61	-0.93	-77.44
3.0	-6.04	-111.81	19.12	-101.86	-64.94	63.84	-0.80	-93.08
3.1	-6.46	-126.18	15.60	-125.84	-65.29	103.36	-0.73	-108.06
3.2	-6.74	-139.55	12.10	-148.15	-76.12	19.05	-0.67	-122.43
3.3	-6.91	-152.76	8.51	-169.35	-64.76	102.40	-0.62	-136.19
3.4	-7.02	-165.47	4.66	170.79	-69.86	137.59	-0.54	-149.53
3.5	-6.99	-176.99	0.35	152.68	-65.06	153.96	-0.47	-162.24
3.6	-6.84	172.04	-5.03	138.01	-63.50	88.03	-0.41	-174.49
3.7	-6.57	161.88	-13.04	137.28	-66.30	58.78	-0.38	174.06
3.8	-6.30	152.18	-17.23	-150.27	-58.06	106.16	-0.37	163.22
3.9	-6.04	143.23	-10.45	-135.35	-60.22	60.37	-0.40	153.18
4.0	-5.83	135.05	-6.91	-147.18	-58.13	54.12	-0.43	143.70
4.1	-5.62	127.63	-4.71	-163.53	-62.57	29.32	-0.49	134.88
4.2	-5.42	120.90	-3.08	177.72	-58.19	68.88	-0.56	126.39
4.3	-5.24	114.55	-1.72	156.43	-58.33	16.63	-0.67	118.23
4.4	-5.07	108.37	-0.60	131.65	-58.92	2.69	-0.79	110.33
4.5	-4.89	102.16	0.01	101.82	-58.16	12.63	-0.95	102.89
4.6	-4.75	95.64	-0.64	67.36	-57.84	-11.34	-1.09	95.88
4.7	-4.68	89.17	-3.44	34.50	-57.37	-17.51	-1.09	88.73
4.8	-4.47	82.84	-8.97	21.77	-57.27	-47.42	-1.02	80.48
4.9	-3.99	74.73	-8.48	53.69	-58.38	-43.04	-0.95	71.12

S-Parameter^[5] (Vdd=VddBias=5.0 V, Vc1=2.0 V, Vc2=1.8 V, Vc3=1.8 V), T=25 °C, 50 Ω matched) Cont.

Freq (GHz)	S11 (dB)	S11 (ang)	S21 (dB)	S21 (ang)	S12 (dB)	S12 (ang)	S22 (dB)	S22 (ang)
5.0	-3.59	61.28	-3.08	29.83	-57.42	-35.25	-0.93	60.96
5.1	-4.37	36.66	-2.57	-19.13	-57.92	-62.36	-0.80	50.35
5.2	-5.26	23.79	-4.28	-53.55	-58.55	-59.91	-0.76	40.57
5.3	-5.88	12.71	-6.50	-80.69	-57.69	-91.30	-0.74	30.57
5.4	-6.20	2.76	-8.78	-103.41	-57.51	-95.73	-0.71	19.99
5.5	-6.25	-7.06	-10.97	-123.32	-57.76	-103.19	-0.67	9.14
5.6	-6.10	-16.77	-13.06	-141.61	-58.97	-109.41	-0.64	-1.94
5.7	-5.80	-25.91	-15.06	-158.95	-54.67	-120.47	-0.63	-13.50
5.8	-5.48	-35.03	-16.98	-175.90	-56.69	-131.66	-0.60	-25.07
5.9	-5.14	-43.63	-18.87	167.55	-56.83	-152.33	-0.60	-36.95
6.0	-4.82	-51.97	-20.74	150.39	-58.21	-152.79	-0.60	-48.72
7.0	-5.11	-132.66	-23.12	-85.01	-64.22	98.12	-1.39	-169.64
8.0	-3.83	107.44	-34.36	57.37	-59.42	24.83	-0.55	105.31
9.0	-4.93	40.09	-28.91	-71.64	-54.36	-71.04	-0.82	21.49
10.0	-5.53	-104.31	-31.42	99.30	-54.74	144.95	-3.07	-136.30
11.0	-3.22	169.79	-49.93	-10.50	-57.78	55.44	-1.21	140.03
12.0	-6.22	60.73	-56.09	-46.50	-55.70	-47.33	-2.57	69.05
13.0	-3.07	-48.51	-42.09	-128.24	-52.00	-159.54	-2.46	-95.76
14.0	-3.97	-101.62	-40.85	123.51	-55.49	157.53	-3.35	178.00
15.0	-5.04	143.00	-36.15	-6.88	-51.09	39.71	-1.86	77.50
16.0	-4.24	8.62	-39.62	179.55	-50.99	-59.49	-8.41	-63.09
17.0	-2.27	-108.22	-46.66	93.23	-48.60	172.19	-0.99	167.24
18.0	-1.14	-174.30	-47.70	6.98	-53.18	84.31	-0.78	127.20
19.0	-4.34	30.77	-43.73	-133.37	-42.83	-15.74	-4.37	6.29
20.0	-2.93	-133.19	-41.47	56.10	-45.27	165.59	-1.75	-145.59

S-Parameter^[5] (Vdd=VddBias=5.5 V, Vc1=2.0 V, Vc2=1.8 V, Vc3=1.8 V), T=25 °C, 50 Ω matched)

Freq (GHz)	S11 (dB)	S11 (ang)	S21 (dB)	S21 (ang)	S12 (dB)	S12 (ang)	S22 (dB)	S22 (ang)
0.1	-0.05	-43.41	-59.26	96.93	-60.56	-156.87	-0.30	166.26
0.2	-0.20	-83.95	-63.48	-48.09	-68.73	73.17	-0.83	156.07
0.3	-0.33	-118.94	-55.05	-83.65	-69.82	117.86	-0.91	147.31
0.4	-0.32	-148.39	-45.15	-55.28	-66.66	59.32	-0.93	137.52
0.5	-0.29	-174.02	-31.01	-63.49	-74.45	149.91	-0.94	127.66
0.6	-0.23	163.15	-17.28	-92.18	-66.22	69.69	-0.96	117.93
0.7	-0.12	141.37	-3.67	-131.53	-66.28	71.54	-1.01	108.30
0.8	-0.56	116.88	10.27	157.42	-70.81	19.85	-1.09	98.77
0.9	-1.84	107.94	14.71	53.14	-73.36	33.95	-1.22	89.55
1.0	-1.39	93.91	16.14	-3.12	-60.59	15.42	-1.34	80.80
1.1	-1.29	77.89	18.55	-55.03	-66.41	-5.14	-1.46	67.91
1.2	-1.46	60.87	20.17	-111.57	-65.11	-12.62	-1.34	60.03
1.3	-2.13	45.59	17.38	-166.86	-67.49	-59.05	-0.88	50.53
1.4	-2.63	33.20	8.48	-111.17	-63.62	-17.80	-0.78	33.70
1.5	-2.59	16.55	23.20	-150.98	-60.37	-64.57	-0.96	34.04
1.6	-3.26	-3.69	26.82	167.44	-62.39	-76.48	-0.80	15.02
1.7	-4.48	-26.73	31.99	129.64	-65.62	-101.90	-1.04	2.90
1.8	-6.90	-54.92	35.96	79.57	-60.29	-65.69	-1.54	-11.81
1.9	-14.65	-93.46	37.86	21.21	-57.67	-52.55	-2.63	-26.71
2.0	-17.42	2.90	36.52	-15.80	-53.43	-63.61	-4.31	-39.36
2.1	-15.03	-4.42	40.48	-58.00	-55.14	-105.91	-6.90	-44.05
2.2	-13.35	-21.65	42.08	-113.77	-52.56	-126.58	-7.83	-42.59

S-Parameter^[5] (Vdd=VddBias=5.5 V, Vc1=2.0 V, Vc2=1.8 V, Vc3=1.8 V), T=25 °C, 50 Ω matched) Cont.

Freq (GHz)	S11 (dB)	S11 (ang)	S21 (dB)	S21 (ang)	S12 (dB)	S12 (ang)	S22 (dB)	S22 (ang)
2.3	-18.31	-21.82	42.39	-170.44	-51.31	-149.44	-9.72	-49.31
2.4	-12.11	26.52	41.79	129.83	-51.67	173.34	-13.78	-15.82
2.5	-6.22	-3.58	39.12	70.51	-51.68	137.22	-6.32	0.70
2.6	-4.67	-35.13	35.01	22.12	-54.35	125.00	-2.91	-21.23
2.7	-4.61	-59.81	30.75	-16.14	-55.30	105.67	-1.62	-42.21
2.8	-4.99	-80.06	26.70	-48.29	-57.92	92.83	-1.09	-60.70
2.9	-5.45	-97.30	22.92	-76.60	-71.59	-37.57	-0.85	-77.36
3.0	-5.91	-112.79	19.30	-102.37	-65.70	36.73	-0.72	-92.89
3.1	-6.33	-127.25	15.78	-126.22	-71.48	111.04	-0.65	-107.77
3.2	-6.59	-140.57	12.29	-148.49	-70.55	45.34	-0.58	-122.12
3.3	-6.74	-153.77	8.71	-169.61	-72.80	91.80	-0.52	-135.88
3.4	-6.82	-166.45	4.87	170.59	-70.33	121.18	-0.44	-149.14
3.5	-6.78	-177.97	0.55	152.52	-63.59	106.84	-0.36	-161.87
3.6	-6.61	171.13	-4.82	137.92	-66.82	130.42	-0.30	-174.10
3.7	-6.35	160.90	-12.86	137.62	-57.85	56.97	-0.28	174.43
3.8	-6.09	151.26	-16.85	-149.92	-58.56	84.26	-0.27	163.58
3.9	-5.83	142.49	-10.13	-135.70	-62.86	50.14	-0.30	153.56
4.0	-5.63	134.32	-6.61	-147.52	-58.80	68.08	-0.34	144.04
4.1	-5.43	126.90	-4.41	-163.96	-56.99	51.06	-0.41	135.17
4.2	-5.24	120.15	-2.78	177.29	-59.93	66.36	-0.49	126.67
4.3	-5.08	113.87	-1.40	155.95	-60.54	37.34	-0.61	118.47
4.4	-4.92	107.72	-0.27	130.87	-59.65	19.57	-0.74	110.59
4.5	-4.75	101.52	0.33	100.58	-56.07	4.88	-0.91	103.16
4.6	-4.63	95.03	-0.39	65.69	-54.64	-23.10	-1.05	96.18
4.7	-4.56	88.57	-3.31	32.85	-56.59	-21.29	-1.04	89.00
4.8	-4.39	82.29	-8.91	21.19	-58.31	-41.89	-0.98	80.67
4.9	-3.94	74.28	-8.23	52.50	-59.45	-37.14	-0.92	71.24
5.0	-3.61	61.01	-2.98	28.17	-59.95	-33.07	-0.91	61.01
5.1	-4.41	36.98	-2.57	-20.46	-57.55	-72.71	-0.79	50.39
5.2	-5.30	24.62	-4.31	-54.54	-56.22	-71.81	-0.76	40.60
5.3	-5.92	14.04	-6.58	-81.33	-56.03	-88.18	-0.74	30.56
5.4	-6.20	4.51	-8.90	-103.67	-56.97	-94.91	-0.70	20.01
5.5	-6.20	-5.13	-11.12	-123.03	-60.23	-105.13	-0.66	9.16
5.6	-6.01	-14.82	-13.17	-140.74	-58.04	-110.34	-0.62	-1.90
5.7	-5.66	-24.22	-15.13	-157.62	-56.77	-107.61	-0.60	-13.48
5.8	-5.34	-33.50	-17.00	-174.30	-57.20	-121.15	-0.56	-25.03
5.9	-4.99	-42.36	-18.84	168.83	-61.46	-164.74	-0.54	-36.85
6.0	-4.67	-50.88	-20.71	152.22	-61.22	-166.08	-0.52	-48.53
7.0	-5.02	-132.43	-22.78	-84.70	-59.87	119.04	-1.15	-169.10
8.0	-3.85	107.23	-34.21	58.74	-58.07	13.28	-0.46	105.57
9.0	-4.96	39.65	-28.69	-70.03	-54.81	-80.12	-0.81	21.44
10.0	-5.51	-104.42	-30.90	99.71	-54.91	144.60	-2.44	-137.42
11.0	-3.24	169.87	-49.39	-6.85	-55.79	52.18	-0.94	138.03
12.0	-6.28	60.37	-56.16	-46.56	-54.40	-25.21	-2.58	69.16
13.0	-3.14	-48.95	-42.18	-125.78	-50.24	-162.84	-2.87	-96.90
14.0	-4.05	-101.67	-41.26	123.50	-57.87	168.13	-3.35	177.07
15.0	-5.10	142.53	-35.81	-9.67	-50.12	36.87	-1.84	77.30
16.0	-4.31	8.79	-40.29	179.61	-49.42	-49.38	-9.61	-57.73
17.0	-2.29	-108.55	-46.34	88.66	-47.95	171.22	-1.16	168.18
18.0	-1.16	-174.54	-46.67	1.51	-51.92	81.61	-0.78	127.39
19.0	-4.39	29.22	-43.44	-138.00	-43.09	-16.13	-4.36	6.80
20.0	-2.96	-134.17	-41.55	52.85	-45.10	163.01	-1.74	-144.60

PCB Land Pattern and Stencil Outline

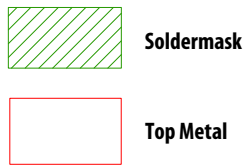
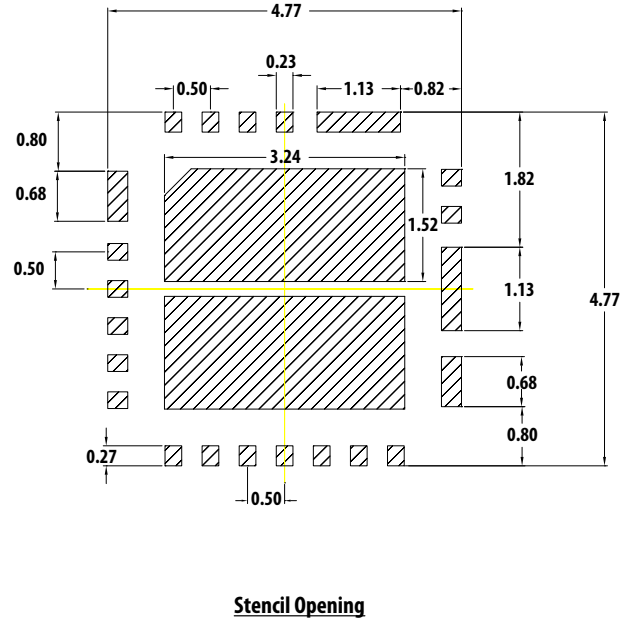
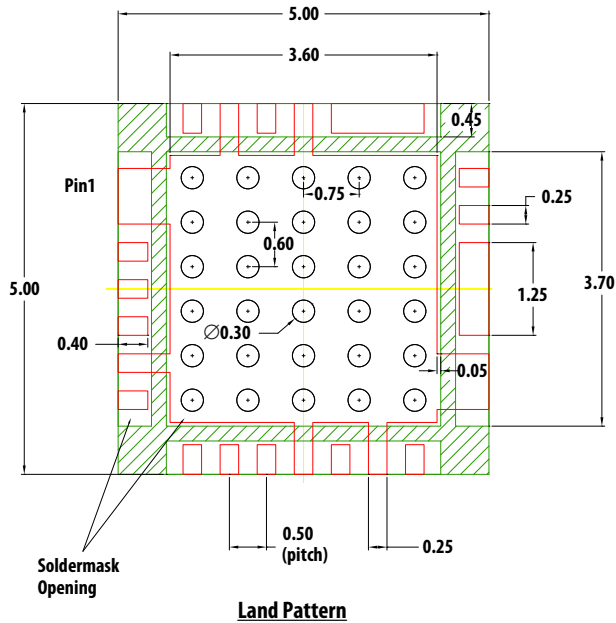

- Note :**
1. Recommended Land Pattern and Stencil.
 2. 4 mils stencil thickness recommended.
 3. All dimensions are in mm

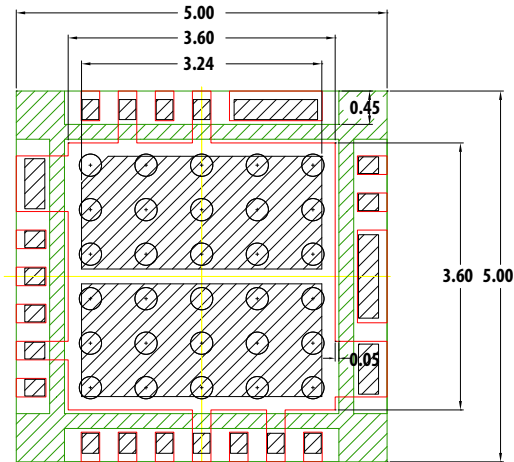

MCOB (5.0 x 5.0 x 0.9) mm 28-Lead Package Dimensions

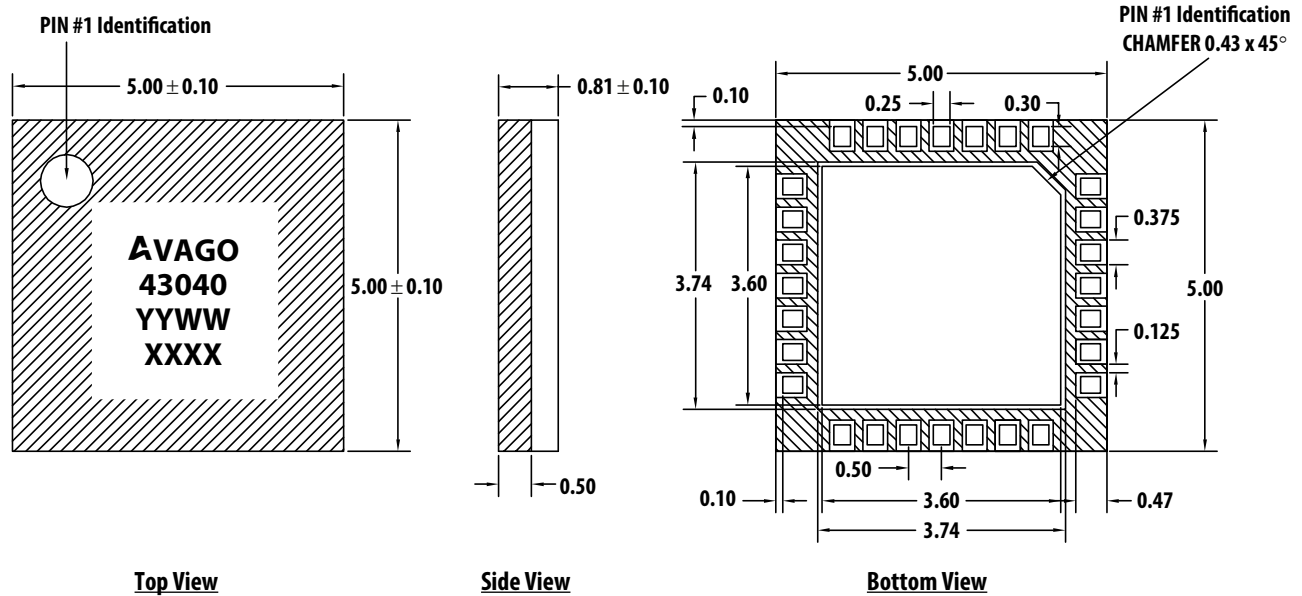

Note

1. All dimensions are in millimeters.
2. Dimensions are inclusive of plating.
3. Dimensions are exclusive of mold flash and metal burr.

Part Number Ordering Information

Part Number	Qty	Container
MGA-43040-BLKG	100	Antistatic Bag
MGA-43040-TR1G	1000	7" Reel

Device Orientation

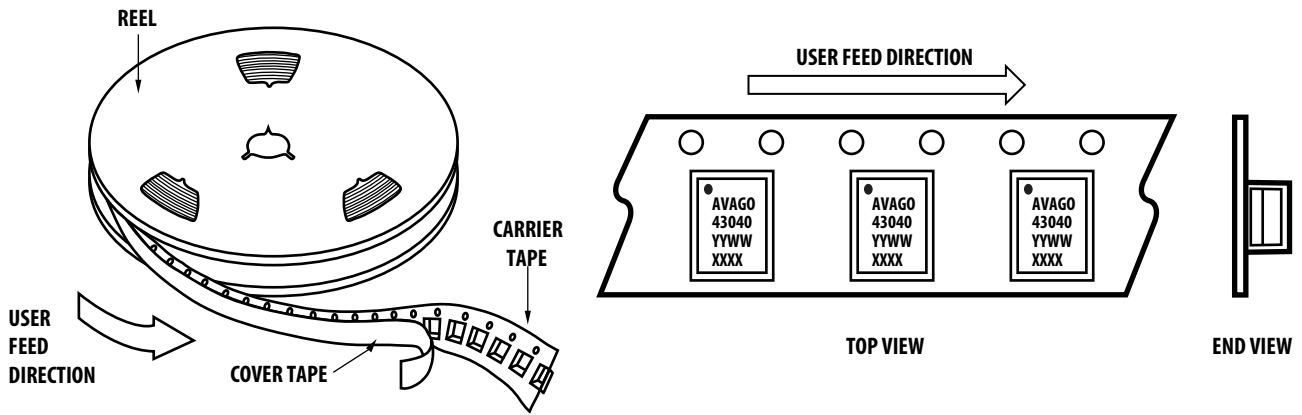

Tape Dimensions

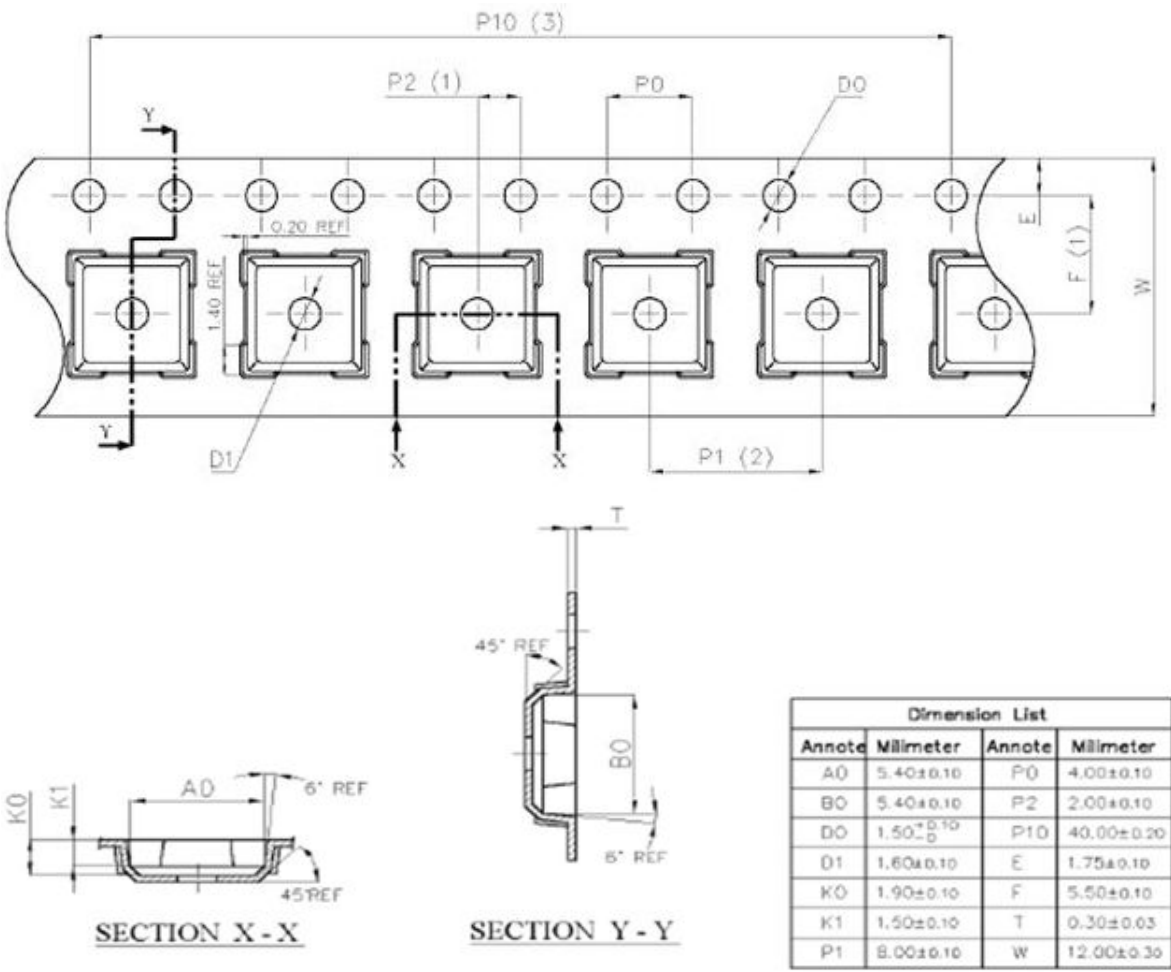

Dimension List			
Annote	Millimeter	Annote	Millimeter
A0	5.40±0.10	P0	4.00±0.10
B0	5.40±0.10	P2	2.00±0.10
D0	1.50 ^{+0.10} ₀	P10	40.00±0.20
D1	1.60±0.10	E	1.75±0.10
K0	1.90±0.10	F	5.50±0.10
K1	1.50±0.10	T	0.30±0.03
P1	8.00±0.10	W	12.00±0.30

Reel Dimensions (7" reel)

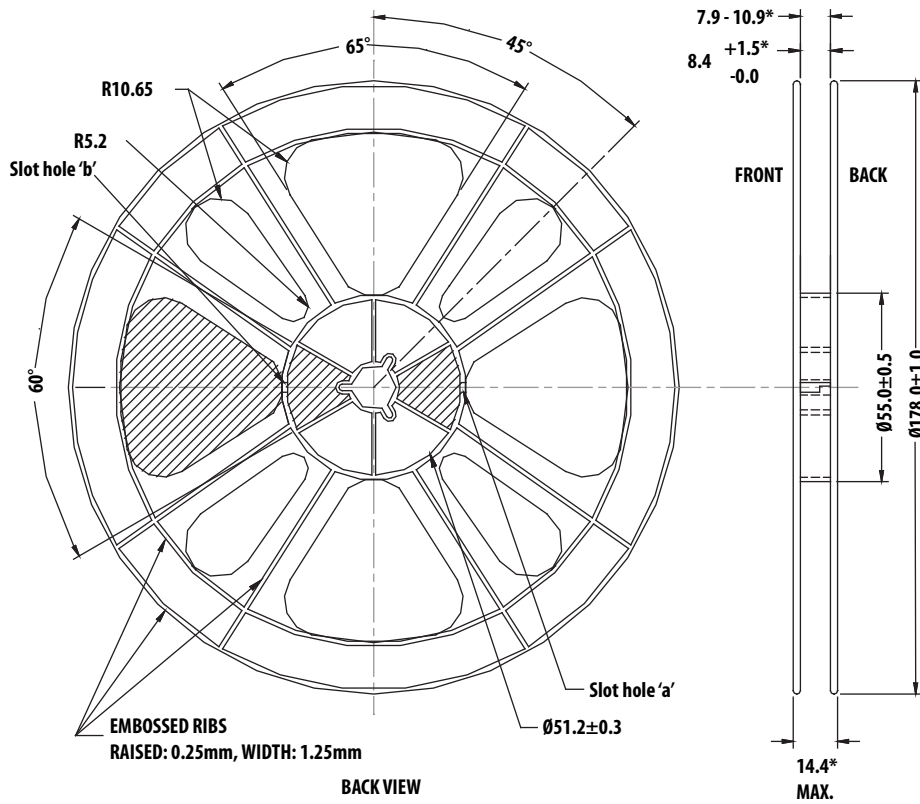
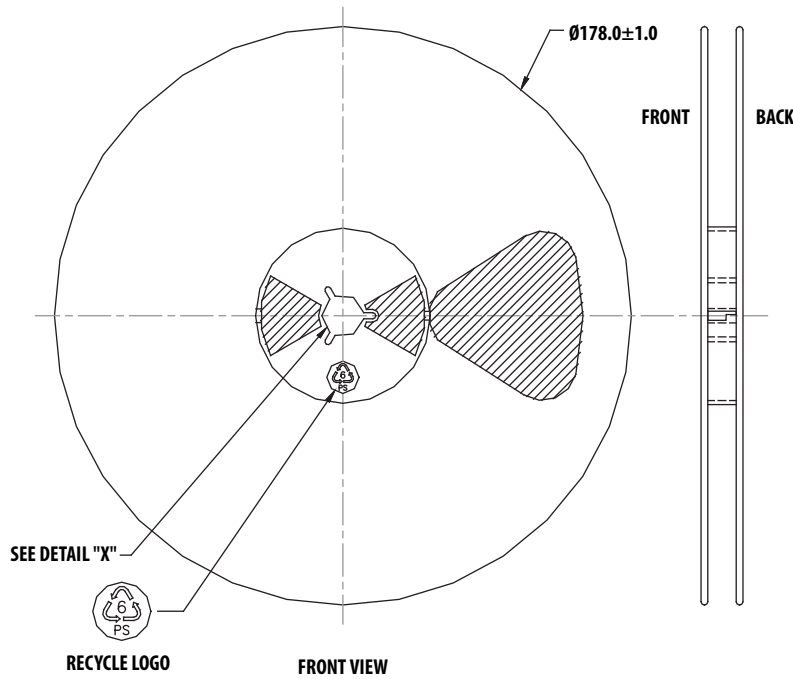

For product information and a complete list of distributors, please go to our web site: www.avagotech.com

Avago, Avago Technologies, and the A logo are trademarks of Avago Technologies in the United States and other countries. Data subject to change. Copyright © 2005-2014 Avago Technologies. All rights reserved. AV02-4488EN - September 23, 2014

