

MGA-638P8

High Linearity Low Noise Amplifier



Data Sheet

Description

Avago Technologies' MGA-638P8 is an economical, easy-to-use GaAs MMIC Low Noise Amplifier (LNA). This LNA has low noise and high linearity achieved through the use of Avago Technologies' proprietary 0.25 μm GaAs Enhancement-mode pHEMT process. It is housed in the miniature 2.0 x 2.0 x 0.75 mm³ 8-pin Dual-Flat-Non-Lead (DFN) package. The device is designed for optimum use from 2.5 GHz up to 4.0 GHz. The compact footprint and low profile coupled with low noise, high gain and high linearity make this an ideal choice as a low noise amplifier for cellular infrastructure applications such as LTE, GSM, CDMA, W-CDMA, CDMA2000 & TD-SCDMA. For optimum performance at lower frequency from 450 MHz up to 1.5 GHz, MGA-636P8 is recommended. For optimum performance from 1.5 GHz up to 2.5 GHz, MGA-637P8 is recommended. All these 3 products, MGA-636P8, MGA-637P8 and MGA-638P8 share the same package and pinout configuration.

Pin Configuration and Package Marking

2.0 x 2.0 x 0.75 mm³ 8-lead DFN

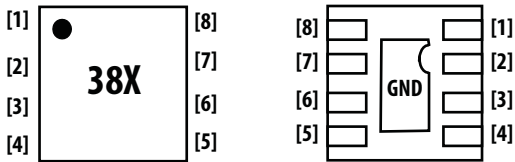

TOP VIEW

- Pin 1 – Not Used
- Pin 2 – RFinput
- Pin 3 – Vbias2
- Pin 4 – Not Used
- Center paddle – GND

BOTTOM VIEW

- Pin 5 – Vbias1
- Pin 6 – PwrDwn
- Pin 7 – RFoutput
- Pin 8 – Not Used

Note:
 Package marking provides orientation and identification
 "38" = Product Code
 "X" = Month Code

It is recommended to ground Pin1, 4 and 8 which are Not Used.

Features

- High linearity performance.
- Low Noise Figure.
- GaAs E-pHEMT Technology^[1].
- Low cost small package size.
- Integrated with active bias and option to access FET gate.
- Integrated power down control pin.

Specifications

2.5 GHz; 4.8 V, 84 mA

- 17.3 dB Gain
- 0.87 dB Noise Figure
- 14 dB Input Return Loss
- +22.6 dBm Input IP3
- +22.2 dBm Output Power at 1 dB gain compression

Applications

- Cellular infrastructure applications such as LTE, GSM, CDMA, W-CDMA, CDMA2000 & TD-SCDMA.
- Other low noise applications.

Note:

1. Enhancement mode technology employs positive Vgs, thereby eliminating the need of negative gate voltage associated with conventional depletion mode devices.



Attention: Observe precautions for handling electrostatic sensitive devices.
 ESD Machine Model = 100 V
 ESD Human Body Model = 350 V
 Refer to Avago Application Note A004R: Electrostatic Discharge, Damage and Control.

Simplified Schematic [1]

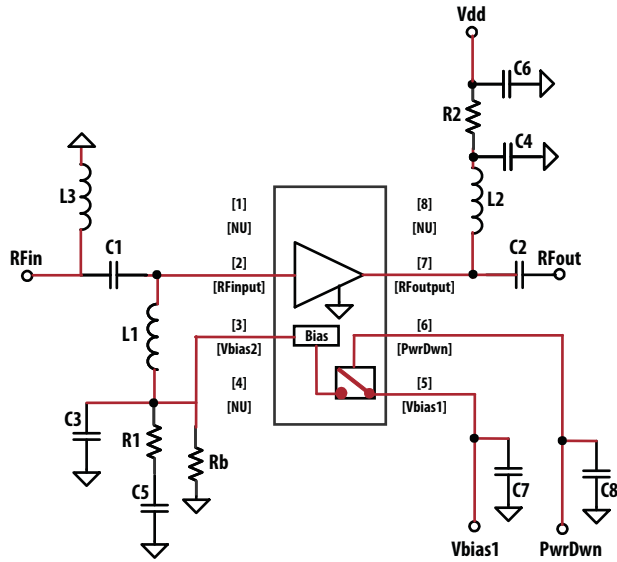

Note:

1. Device is turned ON when PwrDwn pin is applied with 0 V or left open. Device is turned OFF when PwrDwn pin is applied with 3.3 V

Absolute Maximum Rating [1] $T_A=25^\circ\text{C}$

Symbol	Parameter	Units	Absolute Maximum
V_{dd}	Device Voltage, RF output to ground	V	5.5
I_{dd}	Drain Current	mA	125
V_{bias1}	Bias Voltage	V	5.5
V_{pwrDwn}	Power Down Voltage	V	5.5
$P_{in,max}$	CW RF Input Power	dBm	+24
P_{diss}	Total Power Dissipation	W	0.61
T_j	Junction Temperature	$^\circ\text{C}$	150
T_{STG}	Storage Temperature	$^\circ\text{C}$	-65 to 150

Thermal Resistance

Thermal Resistance [2]
 $(V_{dd} = 4.8\text{ V}, I_{dd} = 84\text{ mA})$
 $\theta_{jc} = 67^\circ\text{C/W}$

Notes:

1. Operation of this device in excess of any of these limits may cause permanent damage.
2. Thermal resistance measured using Infra-Red Measurement Technique.
3. Power dissipation with unit turned on. Board temperature T_C is 25°C . Derate at $14.9\text{ mW}/^\circ\text{C}$ for $T_C > 105.8^\circ\text{C}$.

Electrical Specifications^[1,4]

$T_A = 25^\circ\text{C}$, $V_{dd} = V_{bias1} = 4.8\text{V}$, RF measurement at 2.5 GHz, measured on demo board in Figure 5 with component listed in Table 1.

Symbol	Parameter and Test Condition	Units	Min.	Typ.	Max.
I _{dd}	Bias Current	mA	60	84	110
I _{PwrDwn}	Current at V _{PwrDwn} pin when V _{PwrDwn} = 3.3 V (Power Down mode)	mA	–	0.15	–
Gain	Gain	dB	16	17.3	19
NF ^[2]	Noise Figure	dB	–	0.87	1.15
IIP3 ^[3]	Input Third Order Intercept Point	dBm	21	22.6	–
OP1dB	Output Power at 1dB Gain Compression	dBm	–	22.2	–
IRL	Input Return Loss, 50 Ω source	dB	–	14	–
ORL	Output Return Loss, 50 Ω load	dB	–	10	–

Notes:

1. Measurements at 2.5 GHz obtained using demo board described in Figure 5.
2. For NF data, board losses of the input have not been de-embedded.
3. IIP3 test condition: $F_{RF1} = 2.500\text{ GHz}$, $F_{RF2} = 2.501\text{ GHz}$ with input power of -10 dBm per tone.
4. Use proper bias, heatsink and derating to ensure maximum channel temperature is not exceeded. See absolute maximum ratings and application note for more details.

Product Consistency Distribution Charts^[1, 2]

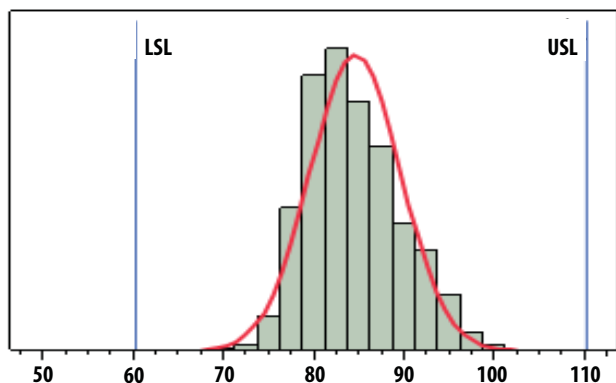

Figure 1. I_{dd}, LSL = 60 mA, nominal = 84 mA, USL = 110 mA

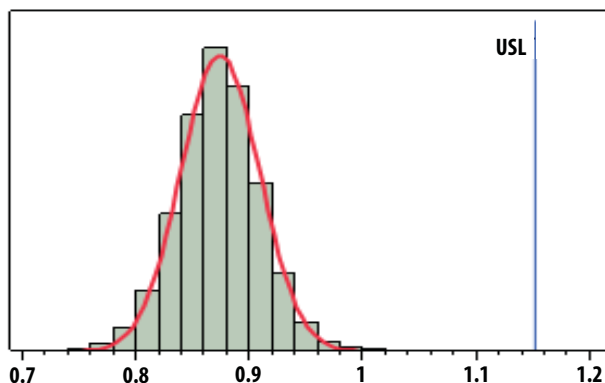

Figure 2. NF, nominal = 0.87 dB, USL = 1.15 dB

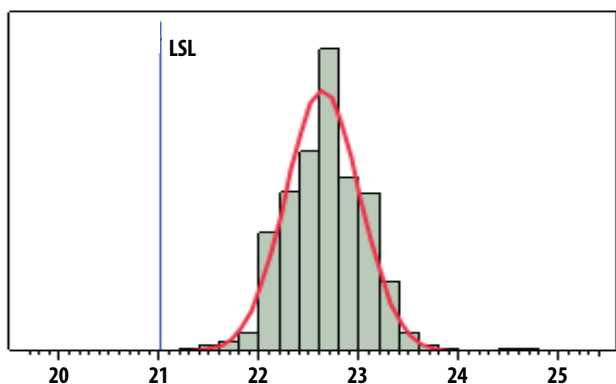

Figure 3. IIP3, LSL = 21 dBm, nominal = 22.6 dBm

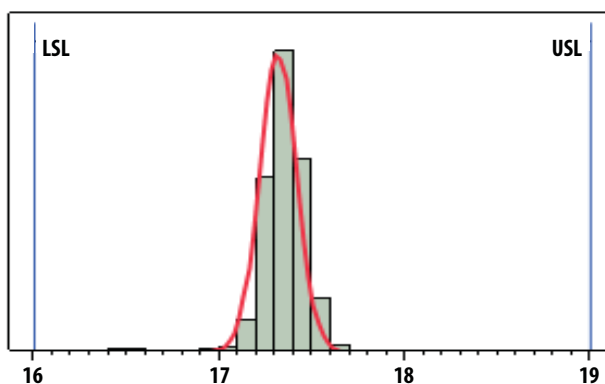

Figure 4. Gain, LSL = 16 dB, nominal = 17.3 dB, USL = 19 dB

Notes:

1. Distribution data sample size is 500 samples taken from 3 different wafer lots. Future wafers allocated to this product may have nominal values anywhere between the upper and lower limits.
2. Circuit trace losses have not been de-embedded from measurements above.

Demo Board Layout

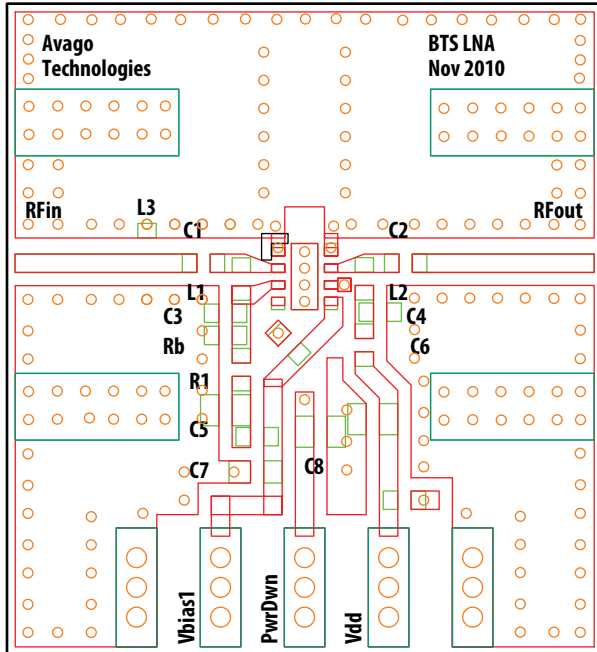
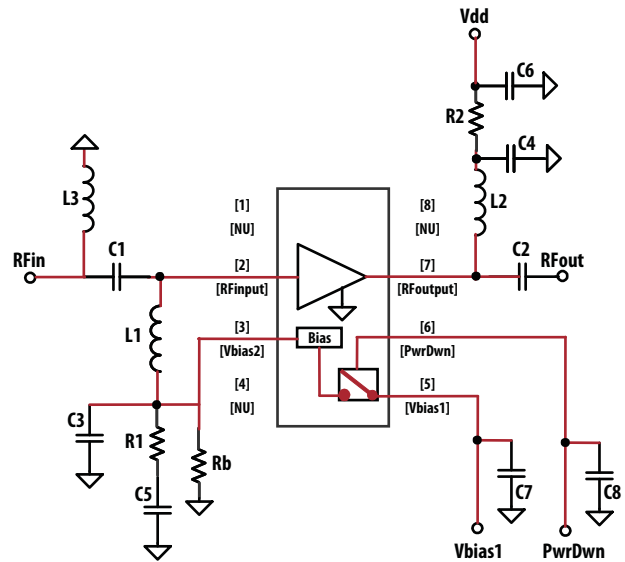

Figure 5. Demo Board Layout Diagram

- Recommended PCB material is 10 mils Rogers RO4350.
- Suggested component values may vary according to layout and PCB material.

Demo Board Schematic



Truth Table

	V _{PwrDwn} (V)
LNA Mode	0 or open
Power Down Mode	3.3

Figure 6. Demo Board Schematic Diagram

Notes:

- The schematic is shown with the assumption that similar PCB is used for all MGA-636P8, MGA-637P8 and MGA-638P8.
- Detail of the components needed for this product is shown in Table 1.

Table 1. Component list for 2.5 GHz matching

Part	Size	Value	Detail Part Number
C1	0402	1.8 pF (Murata)	GRM1555C1H1R8CB01D
C2	0402	100 pF (Murata)	GRM1555C1H101JD01D
C5, C6, C7, C8	0603	4.7 μF (Murata)	GRM188R60J475KE19D
C3, C4	0402	Not Used	
L1	0402	8.2 nH (Toko)	LLP1005-FH8N2C
L2	0402	5.6 nH (Toko)	LLP1005-FH5N6C
L3	0402	1.8 nH (Toko)	LLP1005-FH1N8C
Rb	0402	680 ohm (Rohm)	MCR004YZPJ680
R1	0402	51 ohm (Rohm)	MCR004YZPJ510
R2	0402	0 ohm (Rohm)	MCR01MZPJ000

Notes:

- C1, C2 are DC blocking capacitors
- C1, L1, L3 input match for NF
- L2 output match for IP3
- C5, C6, C7, C8 are bypass capacitors
- R1 is a stabilizing resistor
- Rb is the biasing resistor

Typical Performance

RF performance at $T_A = 25^\circ\text{C}$, $V_{dd} = 4.8\text{ V}$, $I_{dd} = 84\text{ mA}$, measured using 50 ohm input and output board unless stated otherwise. IIP3 test condition: $F_{RF1}-F_{RF2} = 1\text{ MHz}$ with input power of -10 dBm per tone.

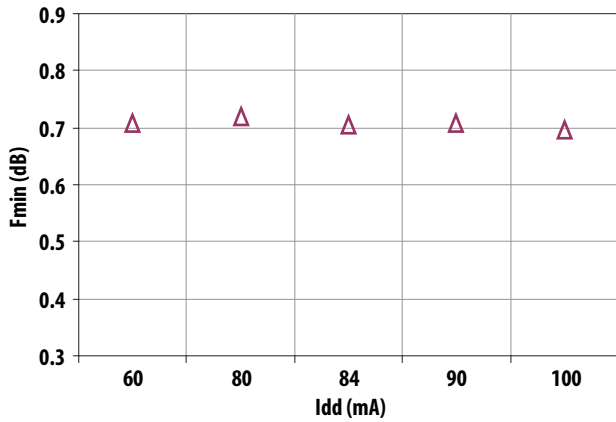

Figure 7. Fmin vs Idd at 4.8 V at 2.5 GHz

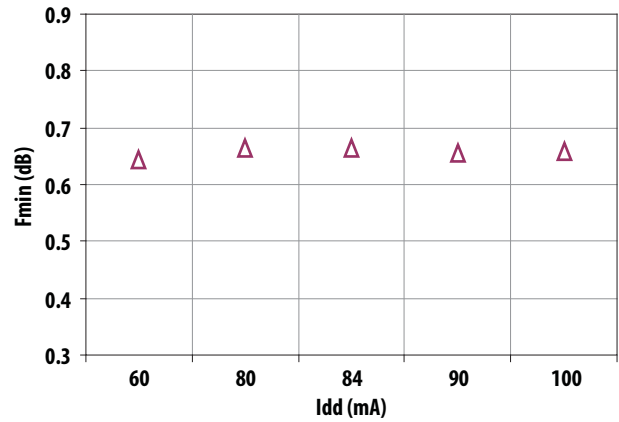

Figure 8. Fmin vs Idd at 4.8 V at 2 GHz

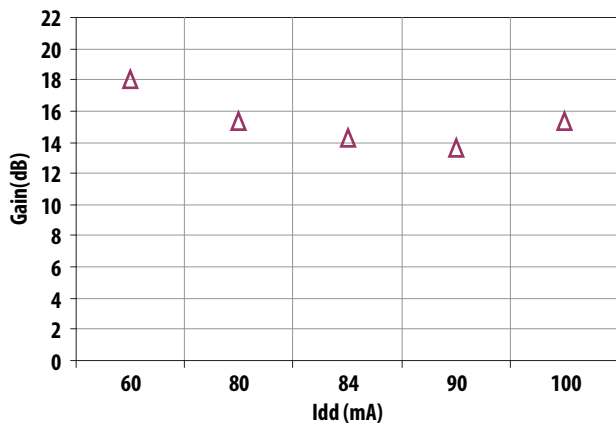

Figure 9. Gain vs Idd at 4.8 V Tuned for Optimum IIP3 and Fmin at 2.5 GHz

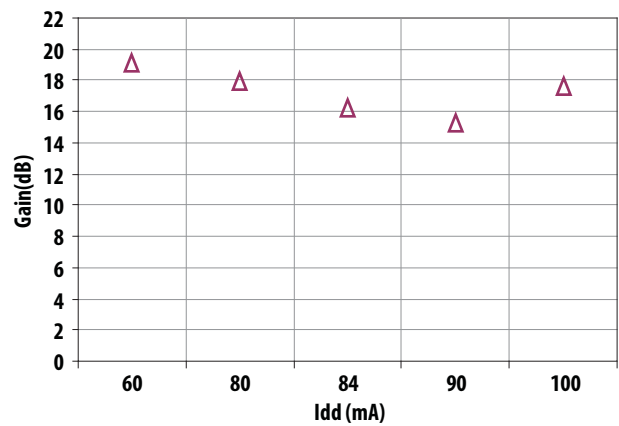

Figure 10. Gain vs Idd at 4.8 V Tuned for Optimum IIP3 and Fmin at 2 GHz

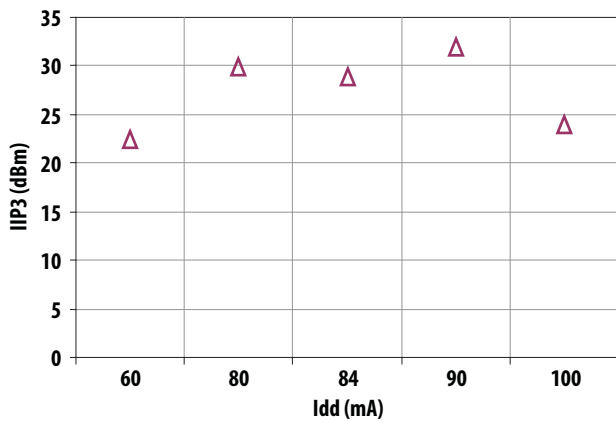

Figure 11. IIP3 vs Idd at 4.8 V Tuned for Optimum IIP3 and Fmin at 2.5 GHz

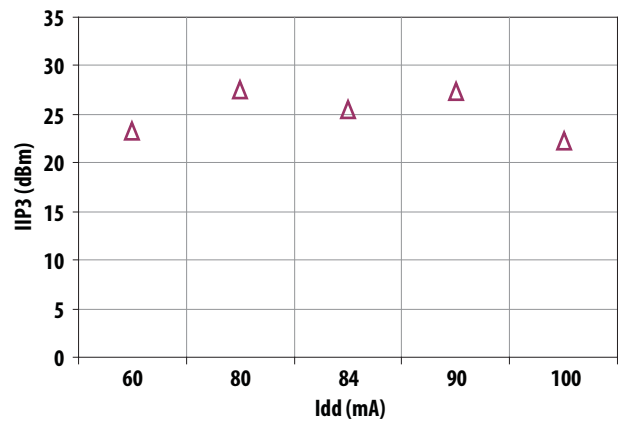

Figure 12. IIP3 vs Idd at 4.8 V Tuned for Optimum IIP3 and Fmin at 2 GHz

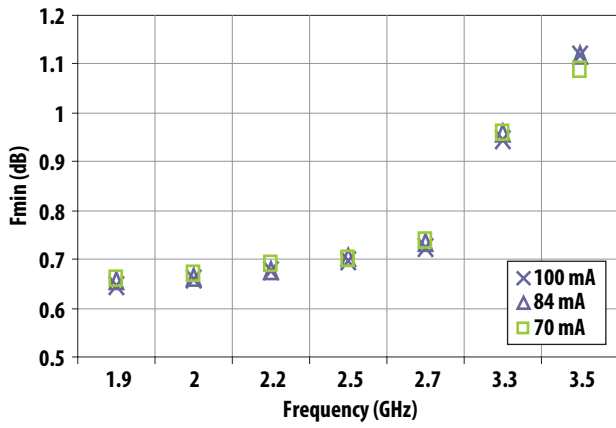

Figure 13. Fmin vs Frequency and Idd at 4.8 V

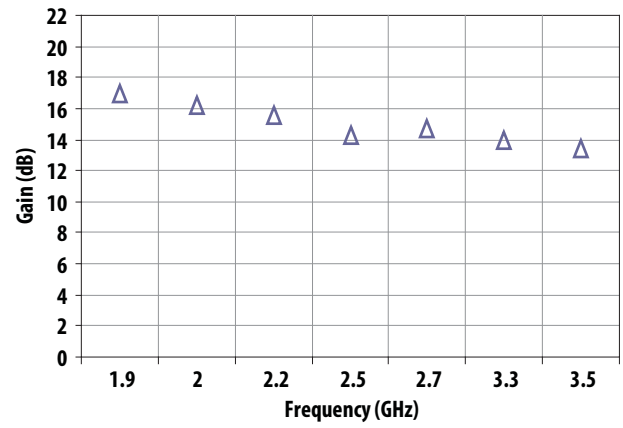

Figure 14. Gain vs Frequency for Optimum IIP3 and Fmin at 4.8 V 84 mA

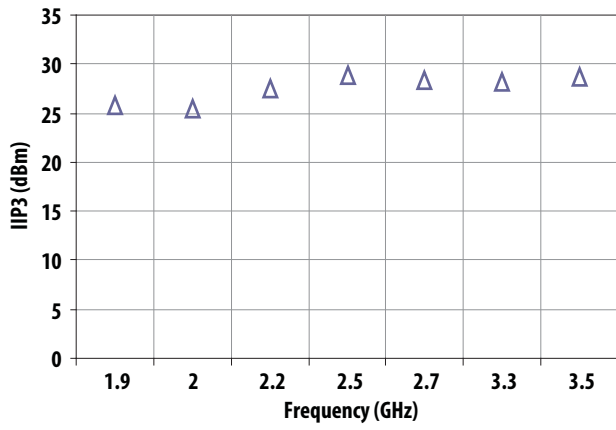

Figure 15. IIP3 vs Frequency for Optimum IIP3 and Fmin at 4.8 V 84 mA

Below is the table showing the MGA-638P8 Reflection Coefficient Parameters tuned for Maximum IIP3, Vdd = 4.8 V, Idd = 84 mA.

Frequency (GHz)	Gamma Load position		IIP3 (dBm)
	Magnitude	Angle	
1.9	0.45	-69.6	26.8
2	0.54	-68.1	28.2
2.2	0.45	-69.8	31
2.5	0.45	-58	30
2.7	0.36	-57.7	31.4
3.3	0.18	-89.9	32.1
3.5	0.18	-59.9	34

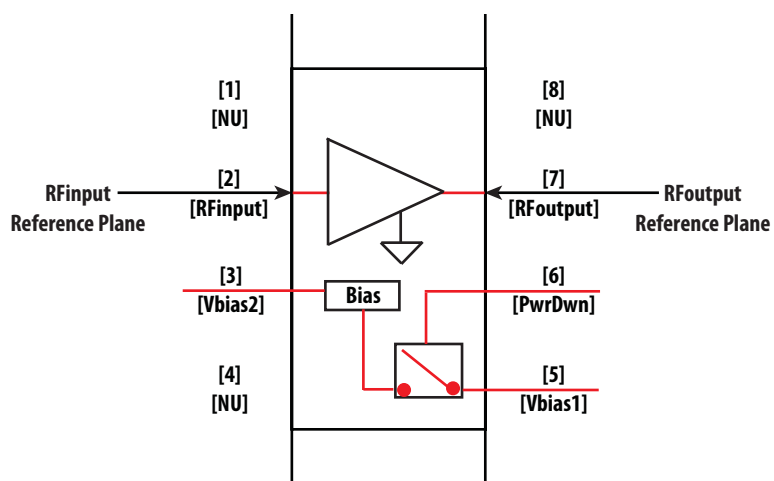

Figure 16. RFinput and RFoutput Reference Plane

Notes:

1. The Maximum IIP3 values are calculated based on Load pull measurements on approximately 100 different impedances using Focus Load pull test system.
2. Measurements are conducted on 0.010 inch thick ROGER 4350. The input reference plane is at the end of the RFin pin and the output reference plane is at the end of the RFout pin as shown in Figure 16.

Typical Performance

RF performance at $T_A = 25^\circ\text{C}$, $V_{dd} = V_{bias1} = 4.8\text{ V}$, $I_{dd} = 84\text{ mA}$, LNA mode, measured on demo board in Figure 5. Signal = CW unless stated otherwise. Application Test Circuit is shown in Figure 6 and Table 1. IIP3 test condition: $F_{RF1} - F_{RF2} = 1\text{ MHz}$ with input power of -10 dBm per tone.

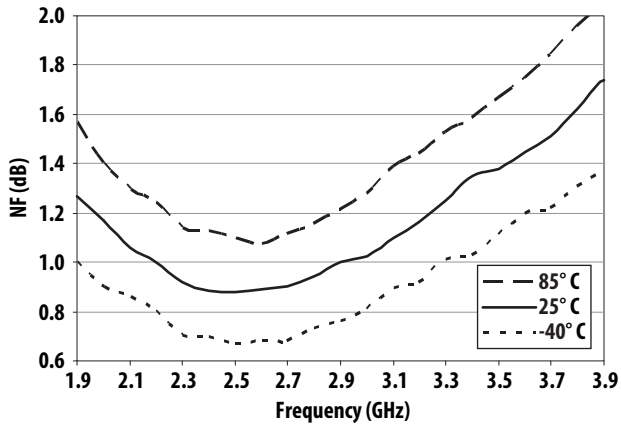

Figure 17. NF vs Frequency vs Temperature

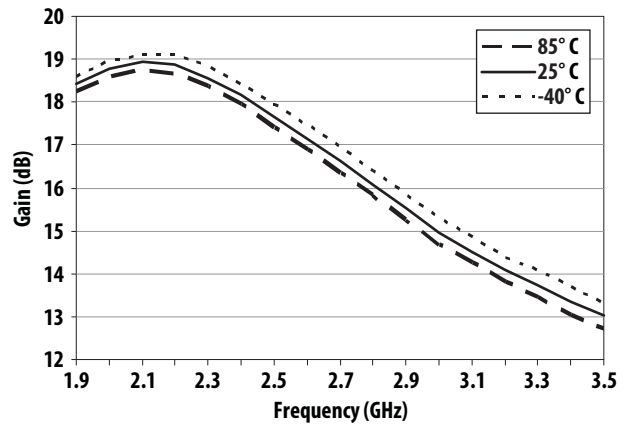

Figure 18. Gain vs Frequency vs Temperature

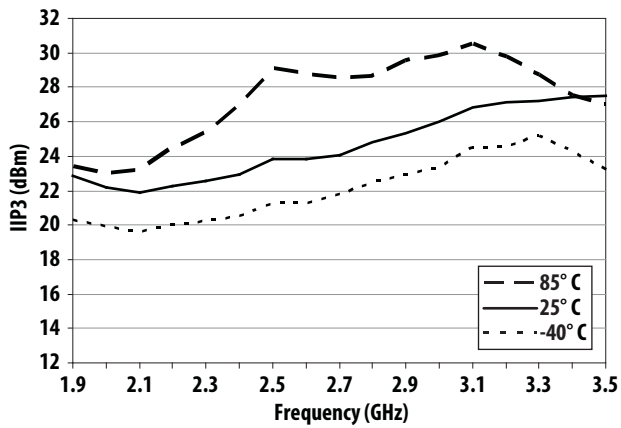

Figure 19. IIP3 vs Frequency vs Temperature

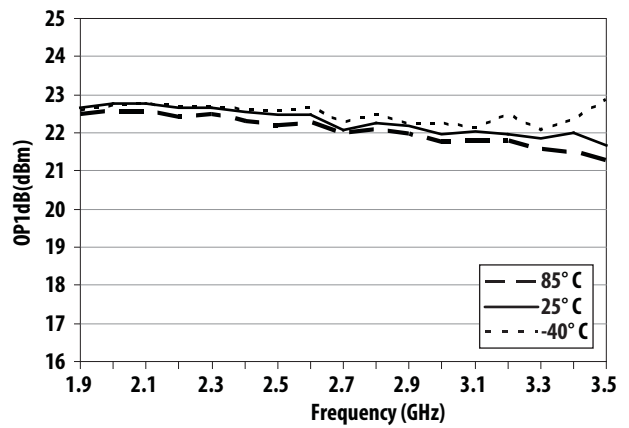

Figure 20. OP1dB vs Frequency vs Temperature

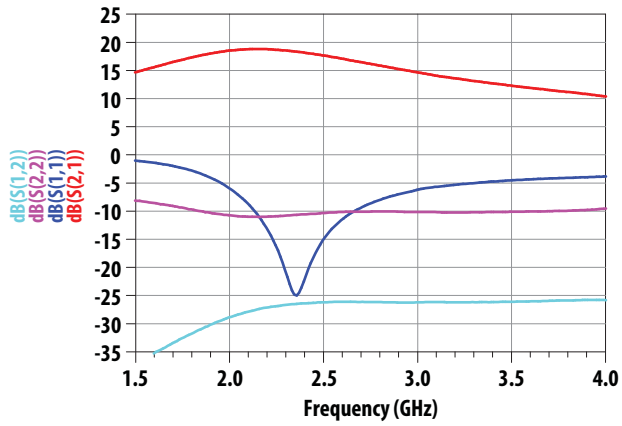

Figure 21. Input Return Loss, Output Return Loss, Gain, Reverse Isolation vs Frequency

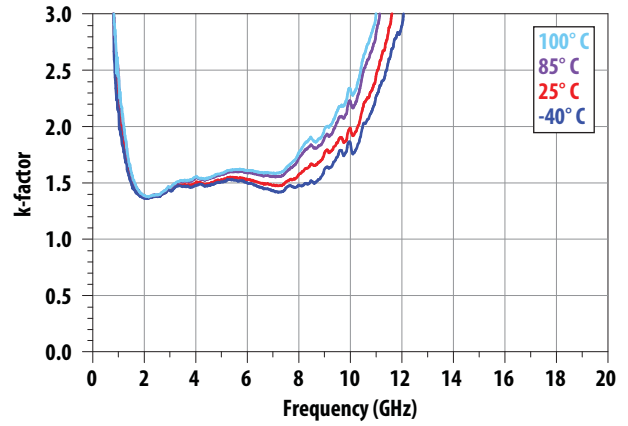

Figure 22. k-factor vs Frequency vs Temperature

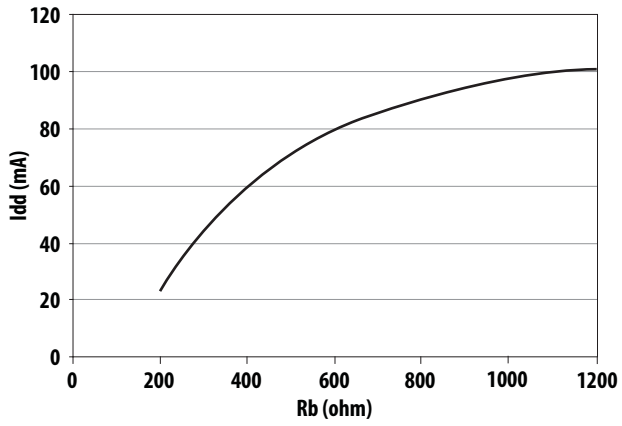

Figure 23. I_{dd} vs R_b

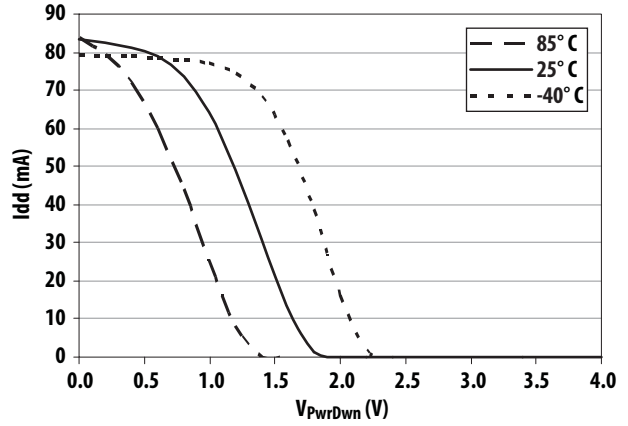

Figure 24. I_{dd} vs V_{PwrDwn}

Typical Scattering Parameters, Vdd = 4.8 V, Idd = 84 mA

LNA SPAR (100 MHz – 20 GHz)

Freq (GHz)	S11 (dB)	S11 (ang)	S21 (dB)	S21 (ang)	S12 (dB)	S12 (ang)	S22 (dB)	S22 (ang)
0.1	0.052	-25.318	34.68	152.786	-47.737	91.863	-4.011	-28.89
0.5	-3.786	-94.894	28.92	107.281	-37.408	58.237	-9.104	-52.056
0.7	-4.926	-113.237	26.654	95.227	-35.752	55.654	-10.055	-57.82
0.9	-5.619	-126.296	24.794	85.752	-34.427	54.436	-10.498	-62.723
1.0	-5.94	-130.828	24.002	81.827	-33.793	54.206	-10.523	-63.981
1	-6.855	-149.182	20.776	64.411	-31.307	51.726	-10.416	-74.85
1.5	-6.979	-155.224	19.732	57.966	-30.494	50.16	-10.335	-80.854
1.7	-7.065	-160.403	18.78	51.816	-29.76	48.458	-10.19	-86.86
1.9	-7.111	-162.698	18.329	48.898	-29.413	47.834	-10.067	-89.923
2.0	-7.134	-172.674	16.343	34.267	-27.955	42.754	-9.537	-104.635
2.5	-7.136	179.587	14.633	20.497	-26.738	37.613	-8.876	-118.233
3	-7.142	173.225	13.156	7.35	-25.665	32.748	-8.157	-130.639
3.5	-7.139	167.248	11.896	-4.959	-24.685	27.439	-7.477	-143.5
4	-7.089	161.143	10.78	-17.688	-23.859	21.999	-7.005	-155.432
4.5	-6.942	155.016	9.656	-30.521	-23.2	16.433	-6.443	-167.299
5	-6.655	148.942	8.55	-43.17	-22.633	11	-5.941	-178.746
5.5	-6.451	142.125	7.548	-55.893	-22.01	5.398	-5.508	169.605
6	-5.788	130.272	5.404	-80.204	-21.138	-5.826	-4.575	148.209
7	-5.04	122.162	3.238	-102.483	-20.538	-15.36	-3.749	131.73
8	-4.687	113.451	1.055	-123.348	-19.722	-23.213	-3.697	119.517
9	-4.53	100.173	-0.705	-145.751	-18.579	-35.202	-2.821	101.483
10	-4.256	84.617	-3.251	-170.507	-18.185	-49.114	-2.62	75.099
11	-3.95	69.227	-6.332	165.37	-17.868	-64.111	-2.273	51.688
12	-3.737	53.796	-10.138	151.871	-18.239	-71.411	-3.688	41.604
13	-3.546	40.2	-12.417	132.898	-16.923	-83.447	-2.495	39.518
14	-3.424	31.813	-16.055	116.123	-16.237	-95.104	-2.974	25.468
15	-3.498	23.38	-20.865	103.357	-15.662	-105.573	-3.854	8.667
16	-3.526	11.48	-28.925	85.718	-15.097	-123.669	-3.569	-9.967
17	-3.178	-0.579	-41.317	-143.263	-15.974	-133.494	-3.394	-14.401
18	-2.789	-13.818	-28.286	-139.464	-16.249	-148.305	-2.439	-20.145
19	-2.6	-28.557	-24.254	-152.264	-16.13	-161.015	-2.919	-18.344
20	0.052	-25.318	34.68	152.786	-47.737	91.863	-4.011	-28.89

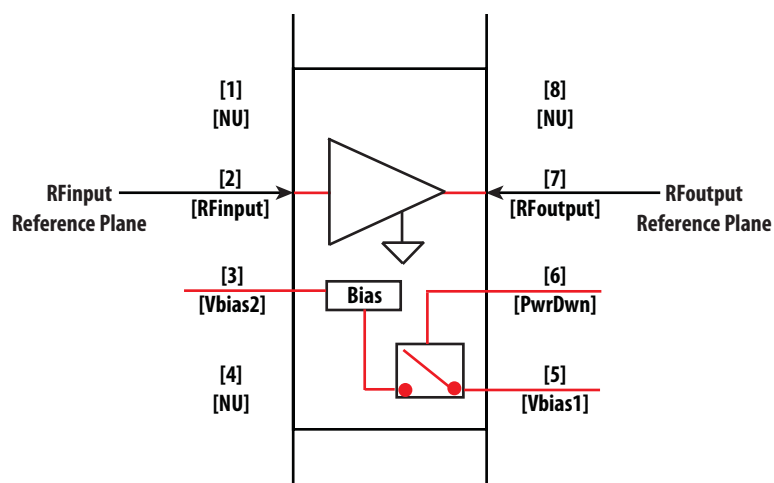

Figure 25. RFinput and RFoutput Reference Plane

Typical Noise Parameters, Vdd = 4.8 V, Idd = 84 mA

Freq GHz	Fmin dB	Γ_{opt} Mag.	Γ_{opt} Ang.	$R_n/50$
1.9	0.656	0.193	152.8	0.044
2	0.664	0.206	156.4	0.040
2.2	0.678	0.234	163.5	0.035
2.5	0.704	0.274	174.2	0.034
2.7	0.736	0.301	181.4	0.036
3.3	0.958	0.383	202.8	0.045
3.5	1.12	0.41	209.9	0.045

Notes:

1. The Fmin values are based on noise figure measurements at 100 different impedances using Focus source pull test system. From these measurements a true Fmin is calculated.
2. Scattering and noise parameters are measured on coplanar waveguide made on 0.010 inch thick ROGER 4350. The input reference plane is at the end of the RFinpin and the output reference plane is at the end of the RFOutpin as shown in Figure 25.

Part Number Ordering Information

Part Number	No. of Devices	Container
MGA-638P8-BLKG	100	Antistatic Bag
MGA-638P8-TR1G	3000	7 inch Reel

DFN2X2 Package Dimensions

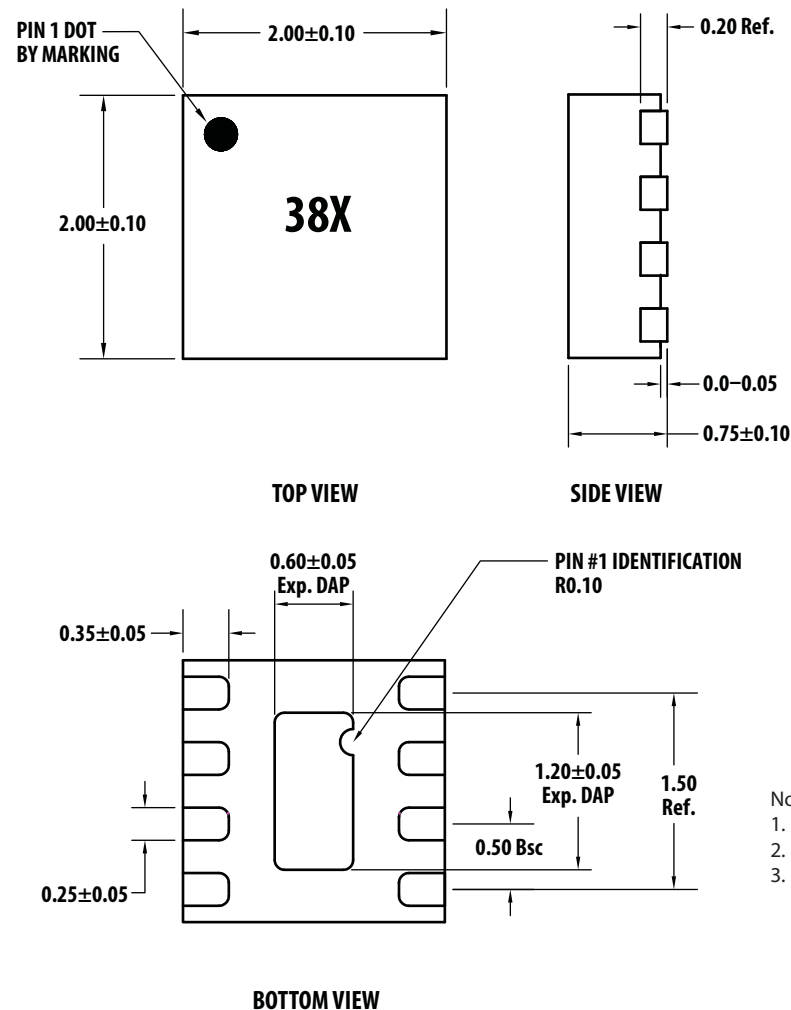

Notes:

1. All dimensions are in millimeters.
2. Dimensions are inclusive of plating.
3. Dimensions are exclusive of mold ash and metal burr.

Recommended PCB Land Pattern and Stencil Design

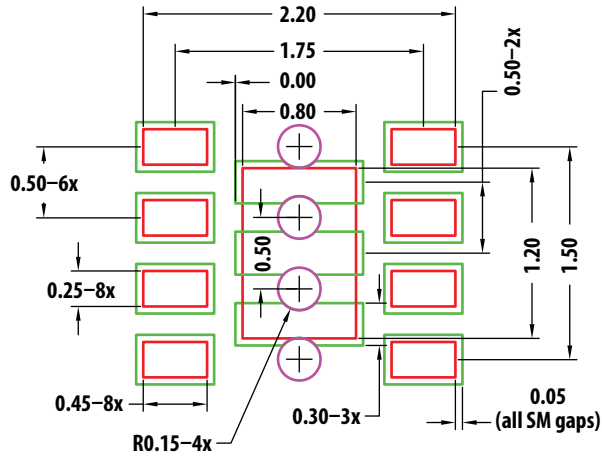

PCB Land Pattern

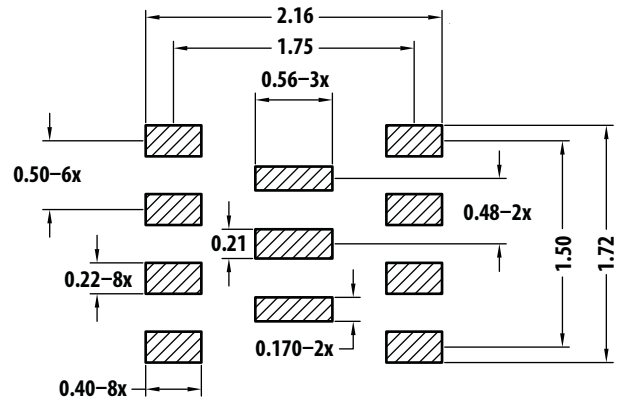

Stencil Design

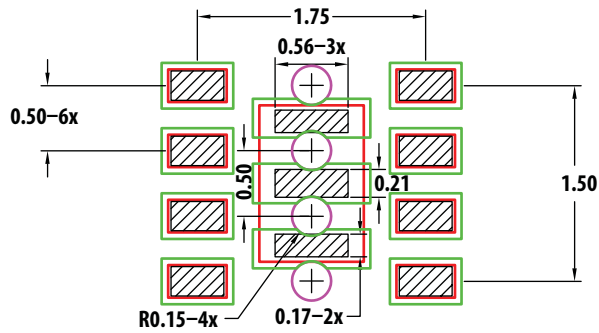

Combines PCB & Stencil Design

All Dimension are in millimeters

Notes:

1. Stencil thickness is 0.1 mm (4 mils).
2. All dimensions are in mm unless otherwise specified.

Device Orientation

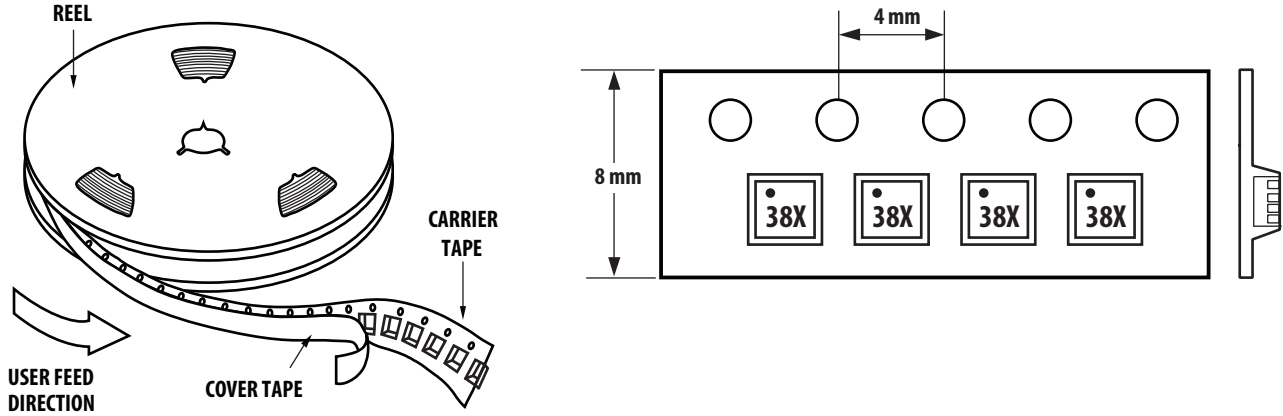

Tape Dimensions

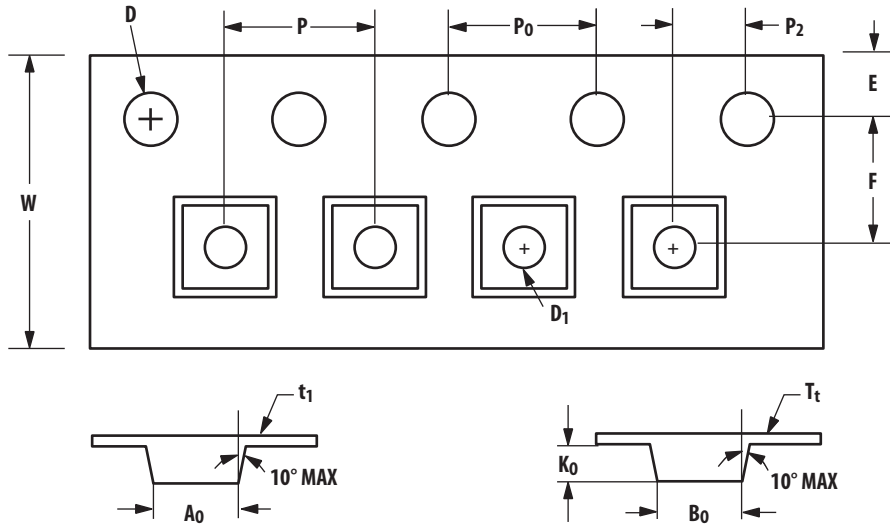

	DESCRIPTION	SYMBOL	SIZE (mm)	SIZE (INCHES)
CAVITY	LENGTH	A_0	2.30 ± 0.05	0.091 ± 0.004
	WIDTH	B_0	2.30 ± 0.05	0.091 ± 0.004
	DEPTH	K_0	1.00 ± 0.05	0.039 ± 0.002
	PITCH	P	4.00 ± 0.10	0.157 ± 0.004
	BOTTOM HOLE DIAMETER	D_1	$1.00 + 0.25$	$0.039 + 0.002$
	PERFORATION	DIAMETER	D	1.50 ± 0.10
PITCH		P_0	4.00 ± 0.10	0.157 ± 0.004
POSITION		E	1.75 ± 0.10	0.069 ± 0.004
		F	3.50 ± 0.05	0.138 ± 0.002
CARRIER TAPE	WIDTH	W	8.00 ± 0.30	0.315 ± 0.012
	THICKNESS	t_1	0.254 ± 0.02	0.010 ± 0.0008
COVER TAPE	WIDTH	C	5.4 ± 0.10	0.205 ± 0.004
	TAPE THICKNESS	T_t	0.062 ± 0.001	0.0025 ± 0.0004
DISTANCE	CAVITY TO PERFORATION (WIDTH DIRECTION)	F	3.50 ± 0.05	0.138 ± 0.002
	CAVITY TO PERFORATION (LENGTH DIRECTION)	P_2	2.00 ± 0.05	0.079 ± 0.002

Reel Dimensions – 7 inch

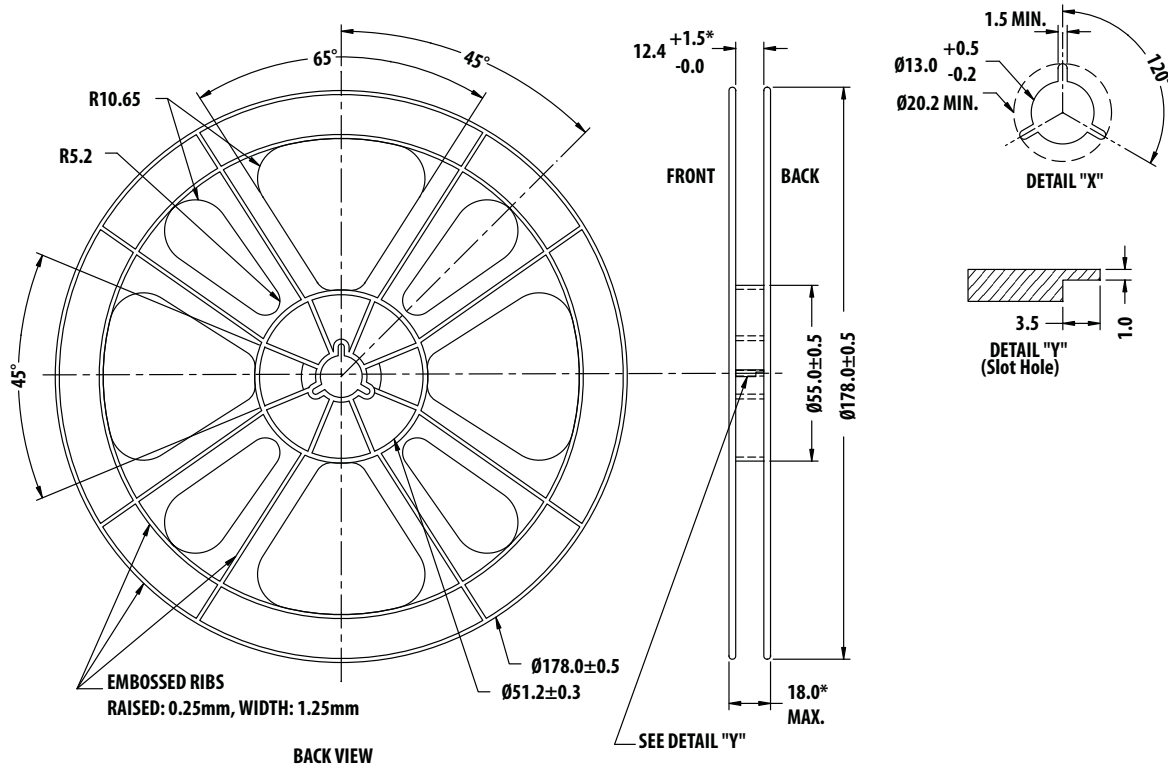
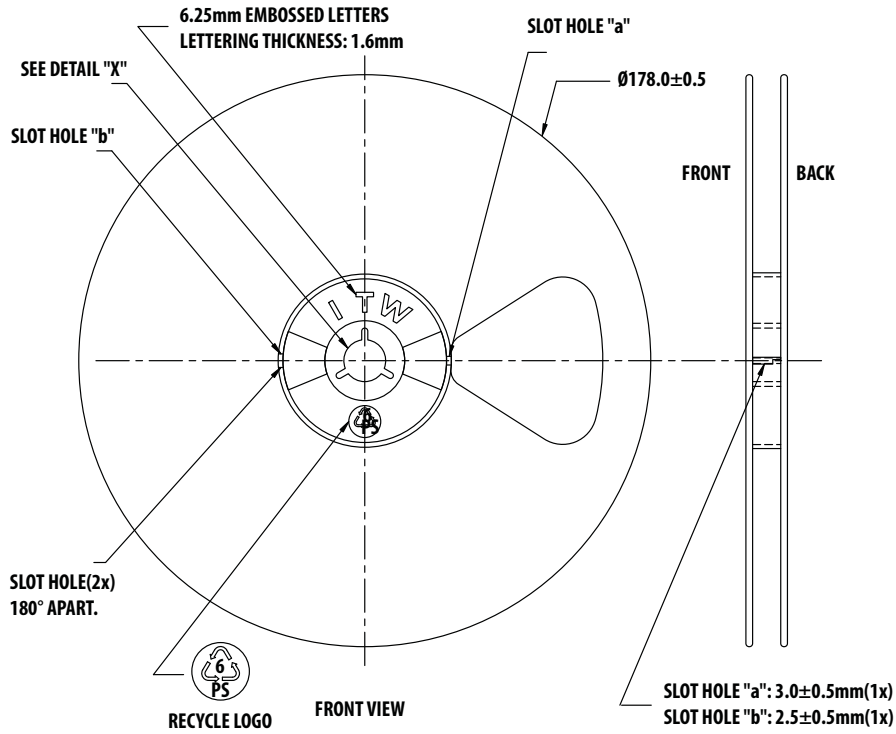

For product information and a complete list of distributors, please go to our web site: www.avagotech.com

Avago, Avago Technologies, and the A logo are trademarks of Avago Technologies in the United States and other countries. Data subject to change. Copyright © 2005-2011 Avago Technologies. All rights reserved. AV02-2993EN - September 29, 2011

