



Industrial DC/DC CONVERTER MGDDI-60 Ultra Wide Input : 60W POWER

Industrial Grade ■

12:1 Ultra Wide Input Dual Outputs Metallic Case - 2 250 VDC Isolation



- Ultra wide input range
- Nominal power up to 60 W
- Nominal dual output voltage from 5V to 48V
- High efficiency over the entire range (typ. 91%)
- Soft start
- Galvanic isolation 2 250 VDC
- Integrated LC input filter
- Permanent short circuit protection
- External trim adjustment : -20/+10%
- No optocoupler for high reliability
- RoHS process

1-General

The MGDDI-60 ultra wide input series designates a full family of DC/DC power modules designed for use in distributed power architecture where variable input voltage for multiple battery and transient are prevalent making them ideal particularly for transportation/mass transit, railways or high-end industrial applications. These modules use a high frequency fixed switching topology at 270KHz providing excellent reliability, low noise characteristics and very high efficiency over the entire input voltage range. Standard models are available with a permanent ultra wide input voltage range of 12-160 volts fully compatible with 24V/36V/72V/110V/125V battery applications. The serie includes dual output voltage choices individually isolated of 2 x 5 volts , 2 x 12 volts, 2 x 15 volts and 2 x 24 volts with easy configurability.

The MGDDI-60 serie is designed in conformity with safety standards EN60950.

All the modules are designed with LC network filters to minimize reflected input current ripple according to ease EN55022 standard.

The modules include a soft-start, an input undervoltage lock-out, a permanent short circuit protection, a thermal protection and an output overvoltage limitation to ensure efficient module protections. The soft-start allows current limitation and eliminates inrush current during start-up. The short circuit protection completely protects the modules against short-circuits of any duration by a shut-down and restores to normal when the overload is removed.

5

2-Product Selection

Dual output model : MGDDI - 60 - -

Input Voltage Range	Output
<p>Permanent</p> <p>R : 12-160 VDC</p>	<p>C : 2 x 5 VDC</p> <p>E : 2 x 12 VDC</p> <p>F : 2 x 15 VDC</p> <p>I : 2 x 24 VDC</p>

2- Product Selection (continued)

Input range	Output	Current per Output	Reference	Options
12-160 VDC	2 x 5 VDC	5 A	MGDDI-60-R-C	/
12-160 VDC	2 x 12 VDC	2,5 A	MGDDI-60-R-E	/
12-160 VDC	2 x 15 VDC	2 A	MGDDI-60-R-F	/
12-160 VDC	2 x 24 VDC	1,25 A	MGDDI-60-R-I	/

Using various parallel or series connections of outputs, and the 80/110% trim capability, allows to cover almost the complete range of output voltages from 4V to 52V as shown in the table below.

Reference	Parallel Connection	Series Connection
MGDDI-60-R-C	4 - 5,5 VDC	8 - 11 VDC
MGDDI-60-R-E	9,6 - 13,2 VDC	19,2 - 26,4 VDC
MGDDI-60-R-F	12 - 16,5 VDC	24 - 33 VDC
MGDDI-60-R-I	19,2 - 26,4 VDC	38,4 - 52,8 VDC

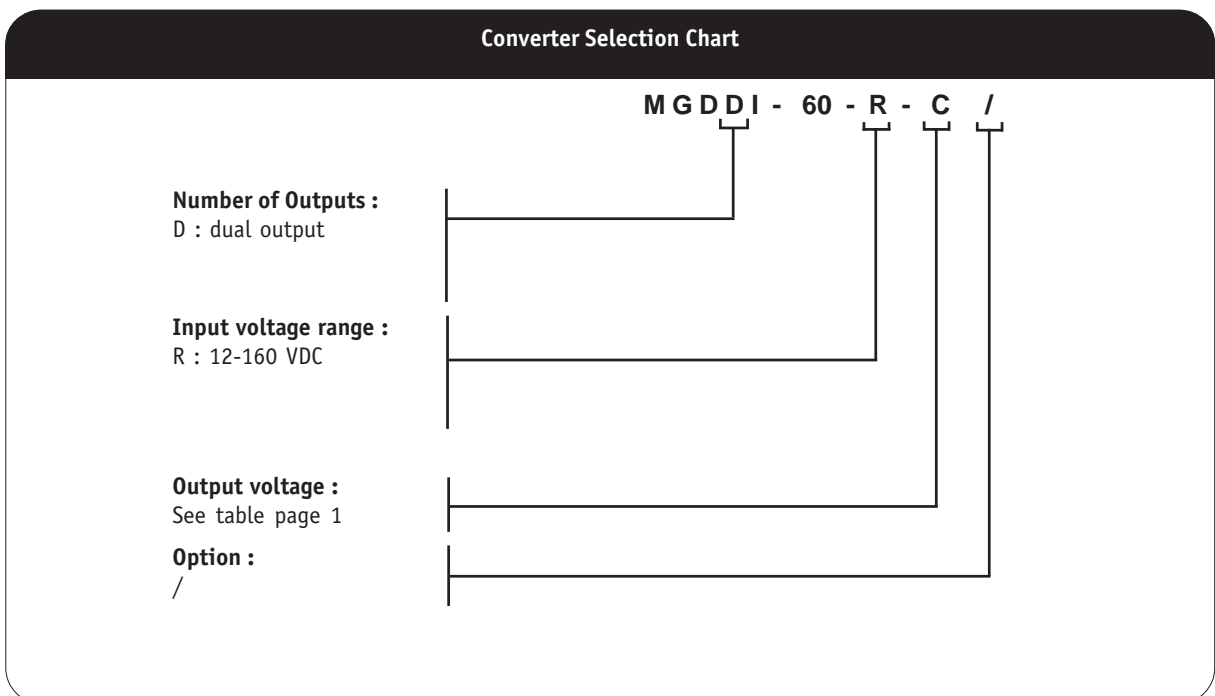

3- Electrical Specifications

Data are valid at +25°C, unless otherwise specified.

Parameter	Conditions	Limit or typical	Units	Dual Output MGDDI-60 - R	
Input					
Nominal input voltage	Full temperature range	Nominal	VDC	48	
Permanent input voltage range (Ui)	Full temperature range Full load see note (1)	Min. - Max.	VDC	12-160	
Undervoltage lock-out (UVLO)	Turn-on voltage (pin Uvlo open)	Maximum	VDC	11,8	
	Turn-off voltage (pin Uvlo open)	Maximum	VDC	10,8	
Start up time	Ui nominal within 3 ms Nominal output Full load : resistive	Maximum	ms	30	
Reflected ripple current	Ui nominal, full load at switching freq. BW = 20MHz	Maximum	% Inom.	TBD	
No load input power	Ui nominal No load	Maximum	W	1	
Standby input power	Ui nominal	Maximum	W	1	
Output					
Output voltage	Full temperature range Ui min. to max. 75% load	Nominal	VDC	2 x 5	
		Nominal	VDC	2 x 12	
		Nominal	VDC	2 x 15	
		Nominal	VDC	2 x 24	
Set Point accuracy	Ambient temperature : +25°C Ui nominal, 75% load	Maximum	%	+/- 2	
Total output power with both outputs	Full temperature range Ui min. to max.	Maximum	W	60	
Output current per output	Full temperature range Full load see note (1) Ui min. to max.	5V output	Nominal	A	5,0
		12V output	Nominal	A	2,5
		15V output	Nominal	A	2,0
		24V output	Nominal	A	1,25
		Unbalanced output	Minimum load on Vo1 for Vo2 proper operation	Typical	W
Ripple output voltage **	Ui nominal Full load BW = 20MHz	5V output	Maximum	mVpp	200
		12V output	Maximum	mVpp	240
		15V output	Maximum	mVpp	300
		24V output	Maximum	mVpp	520
Output regulation * (Line + load + thermal)	Ui min. to max. 0% to full load	Maximum	%	+/- 1,5	
Cross load output regulation	Ui min. to max. V01 at nominal load V02 from 25% to full load	Maximum	%	+/-2	
Output voltage trim	As a function of output voltage	Minimum	%	80	
		Maximum	%	110	
Maximum admissible capacitive load	Ui nominal Full load Per output	5V output	Maximum	µF	2 200
		12V output	Maximum	µF	820
		15V output	Maximum	µF	680
		24V output	Maximum	µF	470
		Efficiency	Ui nominal Full load	Typical	%

Note : Modules have to be mounted with heatsink for electrical tests..

Note (1) : From 12V to 14V and from 140V to 160V a derating of 66% of total maximum permanent power should be observed.

Note * : Regulation is measured with both outputs in parallel configuration.

Note ** : The ripple output voltage is the periodic AC component imposed on the output voltage, an aperiodic and random component (noise) has also to be considered. This noise can be reduced by adding 1 external decoupling capacitor connected between Gin and Gout. These capacitance should be layed-out as close as possible from the converter. The ripple output voltage is measured by connecting a ceramic chip capacitor Co across Vo and Go pins (C=100µF if Vo<5Vdc C=10µF if Vo>5Vdc).

4- Switching Frequency

Parameter	Conditions	Limit or typical	Specifications
Switching frequency	Full temperature range Ui min. to max. No load to full load	Nominal, fixed	270 KHz

5- Isolation

Parameter	Conditions	Limit or typical	Specifications
Electric strength voltage * (Case not connected)	Input to output	Functional	2 250 VDC
	Between outputs	Functional	300 VDC
Isolation resistance	Input to case 500 VDC	Minimum	100 MOhm
	Output to case 500 VDC	Minimum	100 MOhm

*DC-DC converters are defined as component power supplies. As components they cannot comply with the provisions of any safety requirements without global conditions of acceptability (mechanical, conductors,). GAIA Converter DC/DC converter provides functional input-output insulation and functional insulation between outputs. The customer will be responsible to sustain all relevant end-user safety standards and regulations (IEC/EN/UL 60950-1).

6- Protection Functions

Characteristics	Protection Device	Recovery	Limit or typical	Specifications
Input undervoltage lock-out (UVLO)	Turn-on, turn-off circuit with hysteresis cycle	Automatic recovery	Turn-on nominal Turn-off nominal	See section 3
Output current limitation protection (OCP)	Straight line current limitation	Automatic recovery	Typical	130%
Output overvoltage protection (OVP)	Overvoltage protection limitation	Automatic recovery	Nominal	130% of output voltage
Over temperature protection (OTP)	Thermal device with hysteresis cycle	Automatic recovery	Nominal	120°C

7- Reliability Data

Characteristics	Conditions	Temperature	Specifications
Mean Time Between Failure (MTBF) According to MIL-HDBK-217F	Ground Benign	Case at 40°C	1 660 000 Hrs
	Ground fixed (Gf)	Case at 40°C	490 000 Hrs
		Case at 70°C	225 000 Hrs
Ground mobile (Gm)	Case at 40°C	245 000 Hrs	
	Case at 70°C	110 000 Hrs	
Mean Time Between Failure (MTBF) According to IEC-62380-TR	Railway, Payphone	Ambient at 25°C 100% time on	295 000 Hrs

8- Electromagnetic Interference

Electromagnetic interference requirements according to EN55022 class A and class B can be easily achieved as indicated in the following table and following schematics :

Electromagnetic Interference according to EN55022		
Conducted noise emission	Configuration	With a common mode capacitor $C_c = 10nF$ and external filter
	Models	
	All models	Class B
Radiated noise emission	Configuration	With a common mode capacitor $C_c = 10 nF$ and external filter
	Models	
	All models	Class B

8-1 Module Compliance with EN55022 class A/class B Standard

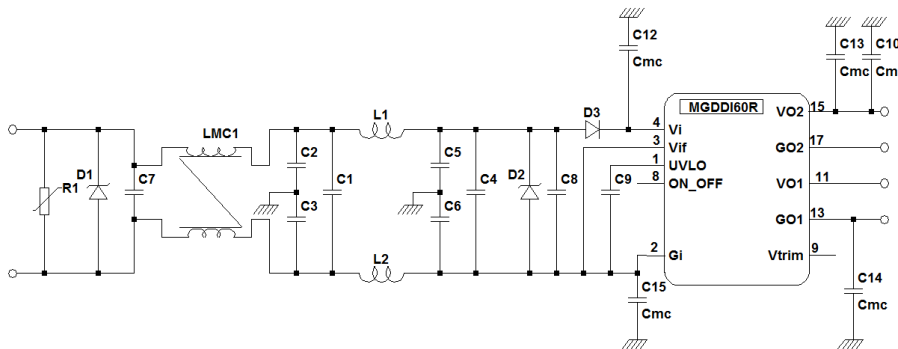

This filter includes 2 functions : an EMI filter part and a surge protection part. Please consult design note "EN50155 Transient/EMI Filter" for further details on this filter.

Note * : C10,C12 to C15 are common mode noise capacitance Cmc

Note ** : transorb and diodes are adequate when surges are specified (see surge susceptibility section on following page).

EN55022 EMI profile for MGDDI-60-R-E at 72 Vdc input

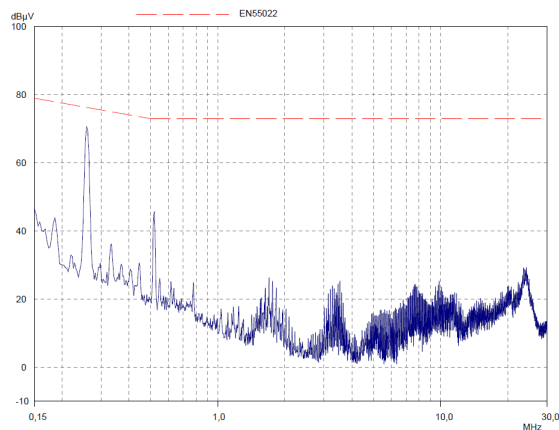

EN55022 EMI profile for MGDDI-60-R-E at 110 Vdc input

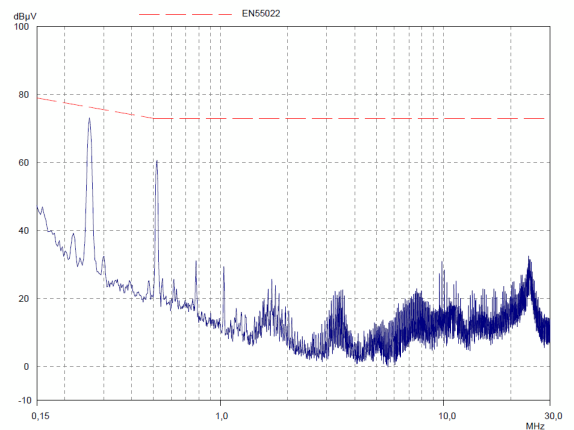

9- Surge Susceptibility EN61000-4-5 & EN50155

Surge susceptibility requirements according to EN50155, EN61000-4-5 can easily be achieved using :

- an input limiter filter : see following schematics of discret components, to sustain the following surge levels :

Characteristics	Standards	Levels
Spikes Line to line	EN 61000-4-5	Level 4 with 4 000 V waveform 50 μ s, impedance 2 Ohm
	EN 50155	Level 1 800 V waveform 50 μ s, impedance 100 and 5 Ohm Level 8 400 V waveform 0.1 μ s, impedance 100 Ohm
Spikes Line to earth	EN 61000-4-5	Level 4 with 4 000 V waveform 50 μ s, impedance 12 Ohm
	EN 50155	Level 1 800 V waveform 50 μ s, impedance 100 and 5 Ohm Level 8 400 V waveform 0.1 μ s, impedance 100 Ohm

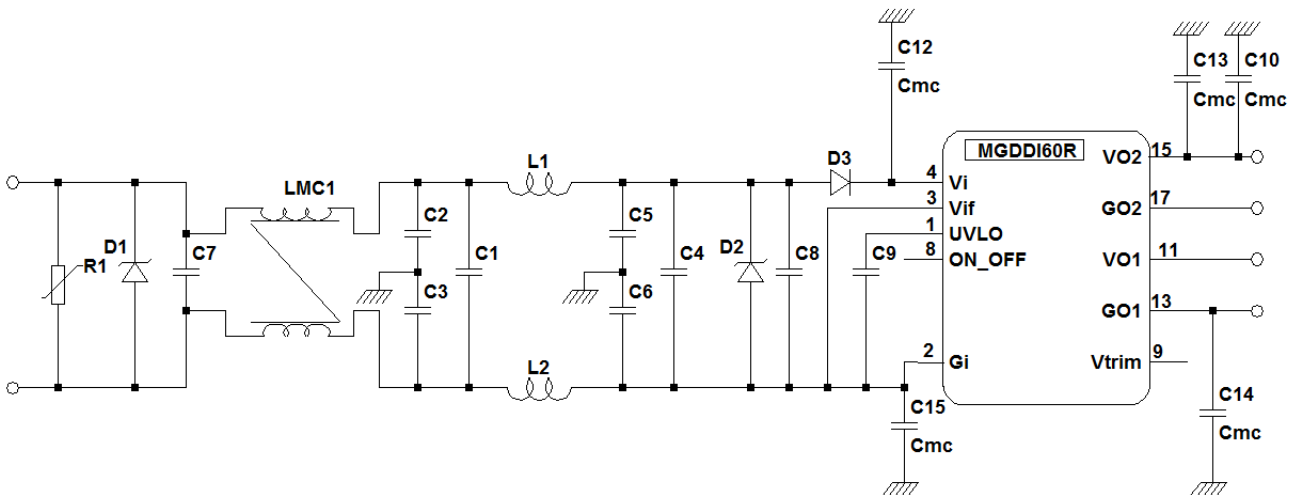

5

Please consult design note "EN50155 Transient/EMI Filter" for further details on components.

10- Thermal Characteristics

Characteristics	Conditions	Limit or typical	Performances
Operating ambient temperature range	Ambient temperature	Minimum Maximum	- 40°C see below
Operating case temperature range at full load	Case temperature	Minimum Maximum	- 40°C see curves hereafter
Storage temperature range	Non functioning	Minimum Maximum	- 40°C + 115°C
Thermal resistance	Rth case to ambient in free air natural convection	Typical	7,5°C /W

The following discussion will help designer to determine the thermal characteristics and the operating temperature.

Heat can be removed from the baseplate via three basic mechanisms :

- Radiation transfert : radiation is counting for less than 5% of total heat transfert in majority of case, for this reason the presence of radiant cooling is used as a safety margin and is not considered.
- Conduction transfert : in most of the applications, heat will be conducted from the baseplate into an attached heatsink or heat conducting member; heat is conducted thru the interface.
- Convection transfert : convecting heat transfer into air refers to still air or forced air cooling.

In majority of the applications, we will consider that heat will be removed from the baseplate either with :

- heatsink,
- forced air cooling,
- both heatsink and forced air cooling.

To calculate the maximum admissible ambient temperature the following method can be used.

Knowing the power used P_{out} and the efficiency η :

- determine the power dissipated by the module P_{diss} that should be evacuated :

$$P_{diss} = P_{out} / (\eta - 1) \quad (A)$$

- then determine the thermal dissipation :

$$T_{diss} = R_{th}(b-a) \times P_{diss} \quad (B)$$

where **Rth(b-a) is the thermal resistance from the baseplate to ambient.**

This thermal $R_{th}(b-a)$ resistance is the summ of :

- **the thermal resistance of baseplate to heatsink (Rth(b-h))**. The interface between baseplate and heatsink can be nothing or a conducting member, a thermal compound, a thermal pad.... The value of $R_{th}(b-h)$ can range from 0.4°C/W for no interface down to 0.1°C/W for a thermal conductive member interface.
- **the thermal resistance of heatsink to ambient air (Rth(h-a))**, which is depending of air flow and given by heatsink supplier.

5

The table hereafter gives some example of thermal resistance for different heat transfert configurations.

Heat transfert	Thermal resistance heatsink to air $R_{th}(h-a)$	Thermal resistance baseplate to heatsink $R_{th}(b-h)$	Global resistance
Free air cooling only	No Heatsink baseplate only :	7,5°C/W	No need of thermal pad 7,5°C/W
	Heatsink Fischer Elektronik SK100 75SA	2°C/W	Bergquist Silpad*or Schlegel OP-8100 : 0,13°C/W 2,13°C/W
	Heatsink Wakefield Thermal Solution 517-94AB (57.9 x 61 x 24)	2°C/W	Bergquist Silpad*or Schlegel OP-8100 : 0,13°C/W 2,13°C/W

Aavid Thermalloy is a heatsink manufacturers. «Silpad» ® is a registered trademark of Bergquist.
Note* : Silpad performance are for Silpad 400 with pressure conditions of 50 Psi.

10- Thermal Characteristics (continued)

The two formulas (A) and (B) described in previous page :

- $P_{diss} = P_{out}(1/\eta - 1)$ (A)
- $T_{diss} = R_{th}(b-a) \times P_{diss}$ (B)

conduct to determine the maximum ambient temperature admissible as a function of the maximum baseplate temperature of the module.

Knowing the maximum baseplate temperature $T_{max_baseplate}$ the maximum ambient temperature is given by the following formula :

$$T_a = T_{max_baseplate} - T_{diss} \quad (C)$$

MGDDI-60 Series Maximum Baseplate Temperature Versus % of Maximum Output Power

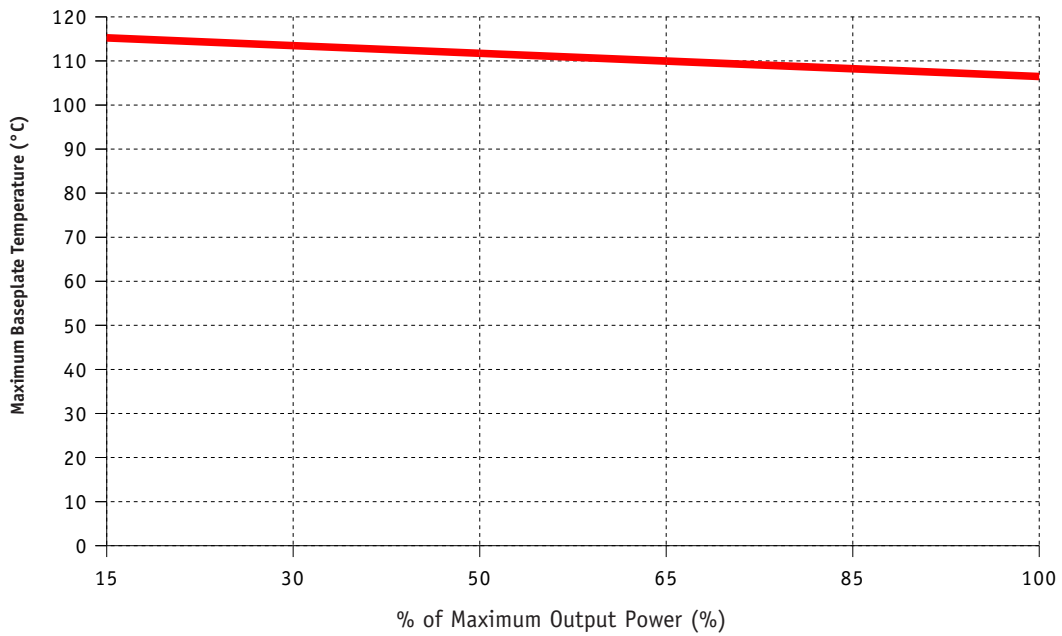

11- Environmental Qualifications

The modules have been subjected to the following environmental qualifications.

Characteristics	Conditions	Severity	Test procedure
Climatic Qualifications			
Life at high temperature	Duration Temperature Status of unit	1 000 Hrs 95°C case unit operating	IEC 68-2-2
Humidity steady	Damp heat Temperature Duration Status of unit	93 % relative humidity 40°C 56 days unit not operating	IEC 68-2-3 Test Ca
Temperature cycling	Number of cycles Temperature change Transfert time Steady state time Status of unit	200 -40°C / +71°C 40 min. 20 min. unit not operating	IEC 68-2-14 Test N
Temperature shock	Number of shocks Temperature change Transfert time Steady state time Status of unit	50 -40°C / +105°C 10 sec. 20 min. unit not operating	IEC 68-2-14 Test Na
Mechanical Qualifications			
Vibration (Sinusoidal)	Number of cycles Frequency : amplitude Frequency : acceleration Amplitude /acceleration Duration Status of unit	10 cycles in each axis 10 to 60 Hz / 0.7 mm 60 to 2000 Hz / 10 g 0.7 mm/10 g 2h 30 min. per axis unit not operating	IEC 68-2-6 Test Fc
Shock (Half sinus)	Number of shocks Peak acceleration Duration Shock form Status of unit	3 shocks in each axis 100 g 6 ms 1/2 sinusoidal unit not operating	IEC 68-2-27 Test Ea
Bump (Half sinus)	Number of bumps Peak acceleration Duration Status of unit	2 000 bumps in each axis 25 g 6 ms unit not operating	IEC 68-2-29 Test Eb
Electrical Immunity Qualifications			
Electrical discharge susceptibility	Number of discharges Air discharge level Contact discharge level Air discharge level Contact discharge level	10 positive & 10 negative discharges 4 kV : sanction A 2 Kk : sanction A 8 Kk : sanction B 4 kV : sanction B	EN55082-2 with : EN61000-4-2 IEC 801-2
Electrical field susceptibility	Antenna position Electromagnetic field Wave form signal Frequency range	at 1 m 10 V/m AM 80%, 1 kHz 26 MHz to 1 GHz	EN55082-2 with : EN61000-4-3 IEC801-3
Electrical fast transient susceptibility	Burst form Wave form signal Impedance Level 1 Level 3	5/50 ns 5 kHz with 15 ms burst duration period 300 ms 50 Ohm 0,5 kV : sanction A 2 kV : sanction B	EN55082-2 with : EN61000-4-4 IEC801-4
Surge Susceptibility	Surge form Impedance Level 4	1,2/50 µs 2 Ohm 4 kV : with transient protection (see section surge)	EN61000-4-5 EN50155

12- Description of Protections

The MGDD-60 series includes 4 types of protection devices.

12-1 Input Undervoltage Lockout (UVLO)

An input undervoltage protection will inhibit the module when input voltage drops below the lock-out turn-off threshold (see section 3 for value) and restores to normal operation automatically when the input voltage rises the lock-out turn-on threshold.

The UVLO voltage can be adjusted using a resistor (R_{uvlo}) connected between pin (1) and GIA. This value can be adjusted in order to allow converter to stop properly accordingly to the input bus (or battery) voltage value. The R_{uvlo} can be determined using the following formula :

$$R_{uvlo} (K\Omega) = [200.3 - V_{uvlo}] / [V_{uvlo} - 11.8]$$

R_{uvlo} = trimming resistance

V_{uvlo} = desire turn-on voltage

Without resistor, the turn on voltage is 11.8V and turn off voltage is 10.8V

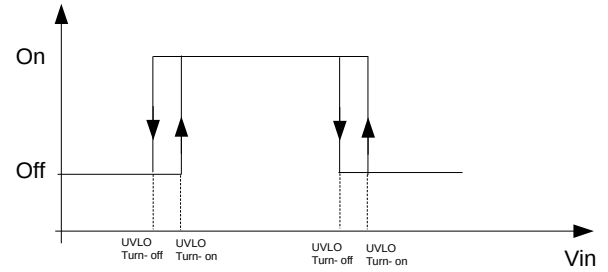
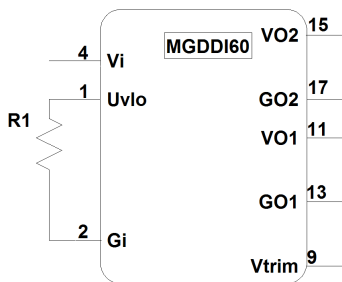

UVLO Voltage trimming

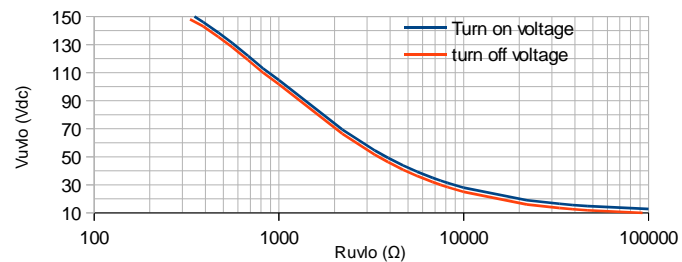

12-2 Output Over Current Limitation Protection (OCP)

The MGDD-60 Series incorporates a overcurrent protection circuit. The overcurrent protection detects short circuit or over current and protects the module according to the hiccup graph . The maximum detection current I_d is depending on input voltage V_{in} , temperature, and is higher than 105 % maximum nominal output current.

When OCP is triggered, the converter falls in hiccup mode by testing periodically if the overload is still present. The module restart automatically in soft-start to normal operation when overcurrent is removed. T_d (detection time) and T_h (hiccup period) are depending on V_{in} and temperature. In hiccup mode the average current is around 25 % of I_{nom} .

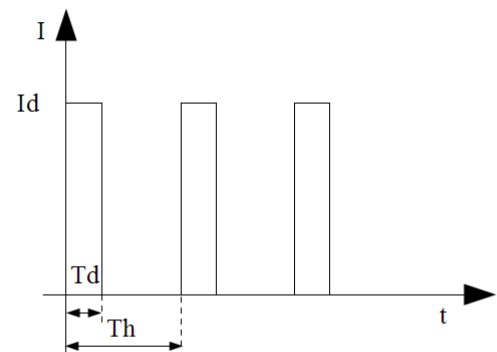

12-3 Output Overvoltage Protection (OVP)

The MGDD-60 series has an internal overvoltage limitation protection circuit that monitors the voltage across the output power terminals. It is designed to limit the converter output voltage to 130% (+/-10%) of nominal output voltage.

12-4 Over Temperature Protection (OTP)

A thermal protection device adjusted at 120°C (+/-5%) internal temperature with 10°C hysteresis cycle will inhibit the module as long as the overheat is present and restores to normal operation automatically when overheat is removed. The efficiency of the OTP function is warranty with the module mounted on a heatsink.

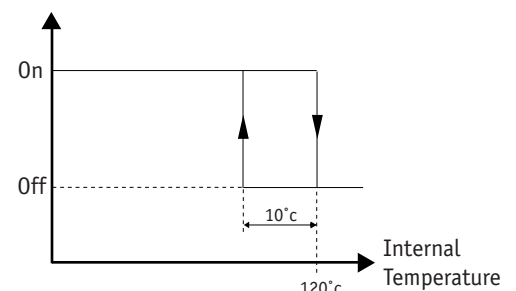

13- Description of Functions

13-1 Connection of Outputs

The outputs of MGDDI-60 can be connected in various configurations such as :

- connections in series
- connection in parallel
- connection in symmetry
- connection in independance

Please note that regulation is achieved through output VO1/GO1 referenced as primary output. When connected in symetrie or independant configurations with unbalanced loads, VO1/GO1 has to be loaded at 6W minimum to insure proper operating of the converter. The VO2/GO2 output referenced as secondary output may stay unloaded, but in that case its regulation may drift up as shown in curve below. There is no minimum load when the two outputs are connected in parallel or balanced serie.

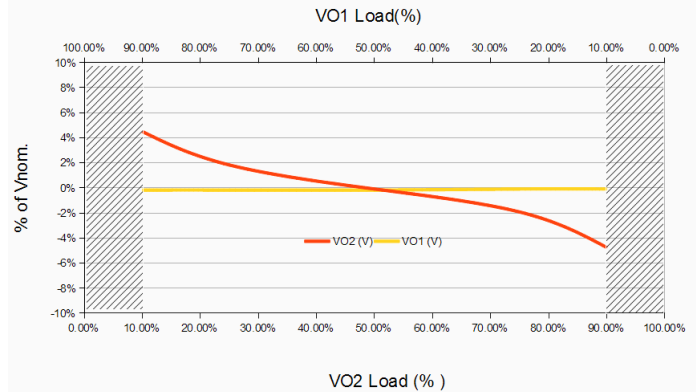
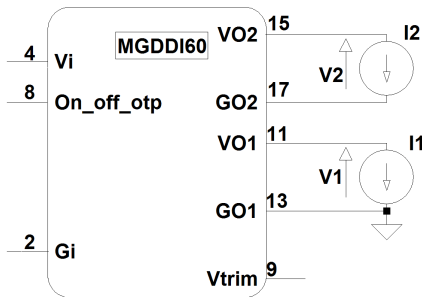

13-1-1 Connection of Outputs in Series

Outputs connected in series allow to achieve 10V, 24V, 30V or 48V output voltages up to 60W total power. These values can be extended using trim adjustment.

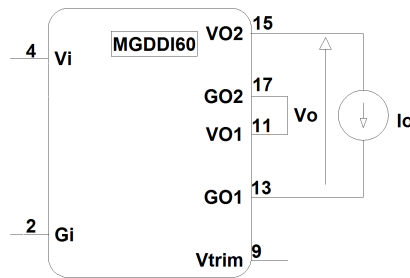

13-1-2 Connection of Outputs in Parallel

Outputs connected in parallell allow to achieve single output 5V, 12V, 15V or 24V up to 60W power. These values can be extended using trim adjustment.

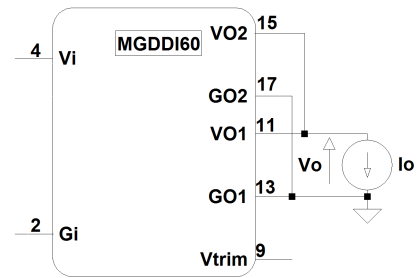

13-1-3 Connection of Outputs in Symmetry

Outputs connected in symmetry allow to achieve +/-5V, +/-12V, +/-15V or +/-24V voltages (+/-30W each) with possible unbalanced load up to 50W on primary output, 10W on secondary output and vice versa.

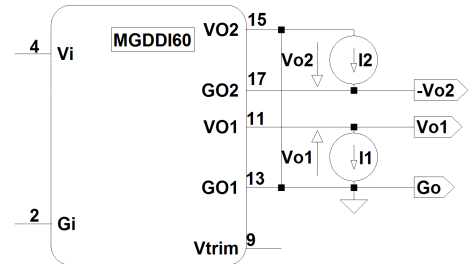

13-1-4 Connection of Outputs in Independance

Outputs connected independantly with floating DC between each other can be achieved for 2x5V, 2x12V, 2x15V or 2x24V voltages (30W each) with possible unbalanced load up to 50W on primary output 10W on secondary output and vice versa.

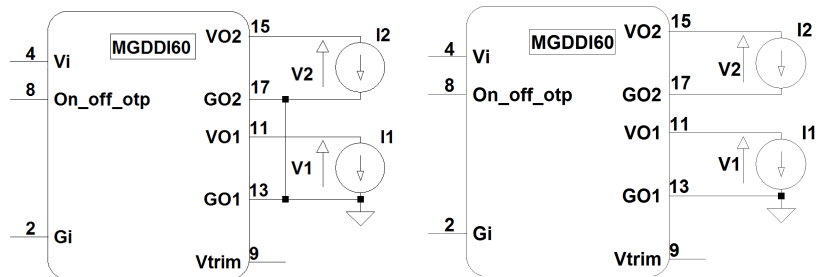

13- Description of Functions (continued)

13-2 Trim Function

The output voltage Vo1 may be trimmed in a range of 80%/110% of the nominal output voltage via a single external trimpot or fixed resistor.

The Vo2 output will automatically follow output Vo1.

Trim Up Function

Do not attempt to trim the module higher than 110% of nominal output voltage as the overvoltage protection may occur.

Also do not exceed the maximum rated output power when the module is trimmed up.

The trim up resistance must be calculated with the following formula :

$$R_u(k\Omega) = \frac{(R1 * VO_{nom} * (VO - V_{ref}))}{((VO - VO_{nom}) * V_{ref})} - R1 - R2$$

Trim Down Function

Do not trim down more than -20% of nominal output voltage otherwise the module may be damaged.

The available output power is reduced by the same percentage that output voltage is trimmed down.

The trim down resistance must be calculated with the following formula :

$$R_d(k\Omega) = \frac{((R1 + R2) * VO - (R2 * VO_{nom}))}{(VO_{nom} - VO)}$$

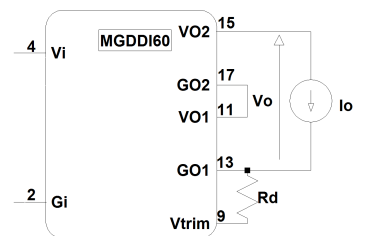
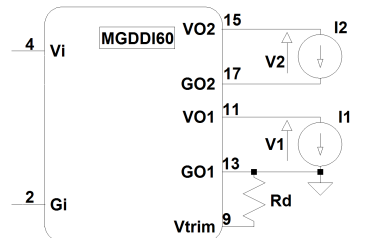
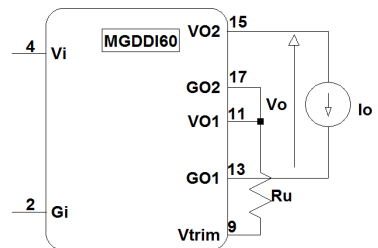
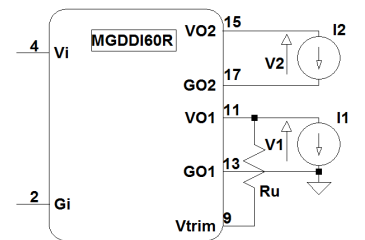

Parameter	Unit	Min.	Typ.	Max.
Trim reference Vref	Vdc	1,2	1,225	1,25
Resistor R1	Ohm	/	3,9K	/
Resistor R2	Ohm	/	270	/

13- Description of Functions (continued)

13-3 On/Off Function

The control pin 8 (On/Off) can be used for applications requiring On/Off operation. This may be done with an open collector transistor, a switch, a relay or an optocoupler. Several converters may be disabled with a single switch by connecting all On/Off pins together.

- The converter is disabled by pulling low the pin 8.
- No connection or high impedance on pin 1 enables the converter.

By releasing the On/Off function, the converter will restart within the start up time specifications given in table section 3

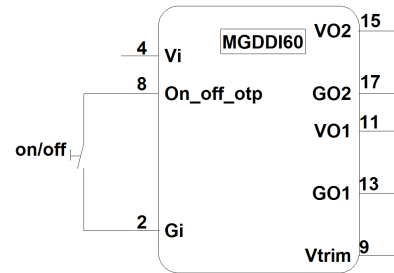

Parameter	Unit	Min.	Typ.	Max.	Notes, conditions
On/Off module enable voltage	Vdc	2.1	/	3.3	Open, the switch must not sink more than 50µA
On/Off module disable voltage	Vdc	0	/	0.5	The switch must be able to sink 0,5mA
On/Off alarm level	Vdc	0	/	0.5	OTP faulty module
On/Off module enable delay	ms	/	/	30	The module restarts with the same delay after alarm mode removed
On/Off module disable delay	µs	/	/	100	Vi nominal, full load

13-4 Input Filter Compensation (VIF)

The «VIF» pin is a direct access to the capacitor of the LC input filter and allows to increase the C value to enhance the converter's stability and performance and to reduce the input current ripple for improved EMI performance. It is recommended to provide low ESR ceramic capacitors, total value can range from 2.2µF for high input voltage use to 10µF for low input voltage use. These capacitors should have the proper voltage rating. Because of high current flowing through it, it should be connected between «VIF» and «Gin» as close as possible from the converter, using large copper traces.

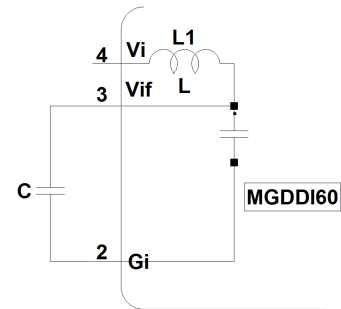

The capacitor on Vif helps reducing conducted EMI level : the difference between blue green curve beside highlights the effect of VIF capacitor.

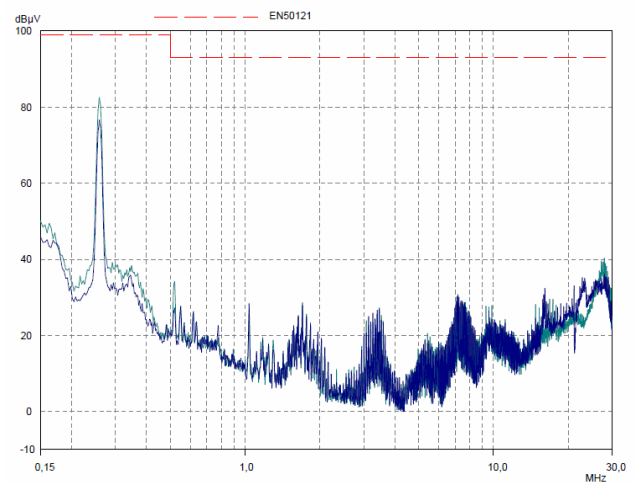

14- Dimensions

Dimension are given in mm. Tolerance : +/- 0,2 mm (+/- 0.01 ") unless otherwise indicated.
Weight : 100 grams (3.6 Ozs) max.

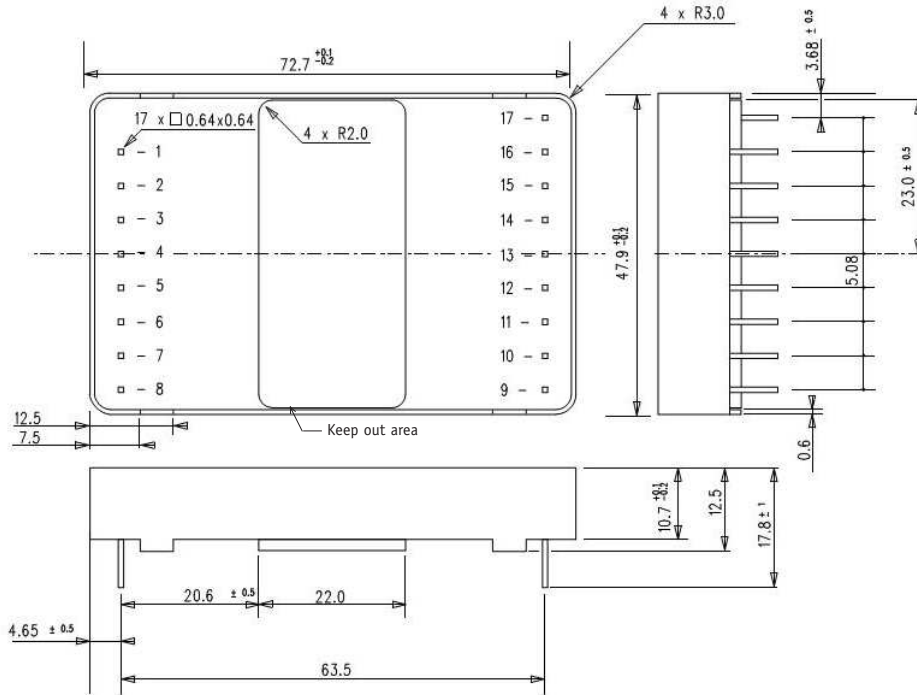

15- Materials

Case : Metallic black anodized coating.
Pins : Flash gold plating over nickel underplate.

16- Product Marking

Upper face : Company logo.
Side face : Module reference, option, date code : year and week of manufacturing.

17- Connections

The MGDDI-60 series has been designed for on-board mounting.
it is recommended not to lay-out any component under the module.

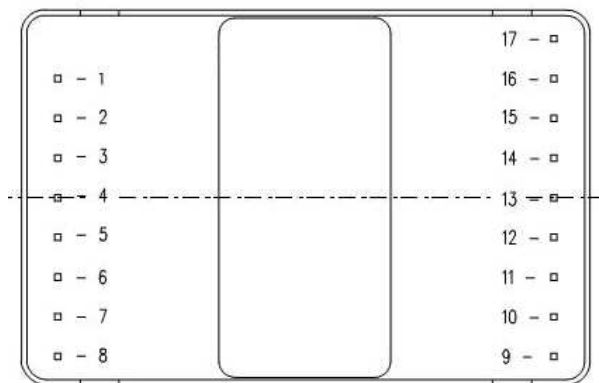

Bottom view

Pin	Single
1	UVLO
2	- Input (Gi)
3	VIF
4	+ Input (Vi)
5, 6, 7	Do not connect
8	On/Off
9	Vtrim
10	Do not connect
11	+ Output 1 (Vo1)
12	Do not connect
13	- Output 1 (Go1)
14	Do not connect
15	+ Output 2 (Vo2)
16	Do not connect
17	- Output 2 (Go2)



For more detailed specifications and applications information, contact :

International Headquarters

GAIA Converter - France
ZI de la Morandière
33185 LE HAILLAN - FRANCE
Tel. : + (33)-5-57-92-12-80
Fax : + (33)-5-57-92-12-89

North American Headquarters

GAIA Converter Canada, Inc
4038 Le Corbusier Blvd
LAVAL, QUEBEC - CANADA H7L 5R2
Tel. : (514)-333-3169
Fax : (514)-333-4519

Represented by :