

L & S BAND GaAs FET [SMD non - matched]**DESCRIPTION**

The MGF0915A GaAs FET with an N-channel schottky Gate, is designed for use UHF band amplifiers.

FEATURES

- High output power
Po=36.5 dBm(TYP.) @f=1.9GHz,Pin=23dBm
- High power gain
Gp=14.5 dB(TYP.) @f=1.9GHz
- High power added efficiency
 η_{add} =50 %(TYP.) @f=1.9GHz,Pin=23dBm
- Hermetic Package

APPLICATION

- For UHF Band power amplifiers

QUALITY

- GG

RECOMMENDED BIAS CONDITIONS

- Vds=10V • Ids=800 mA • Rg=100 Ω

Delivery -01:Tape & Reel(1K), -03:Trai(50pcs)

Absolute maximum ratings (Ta=25°C)

Symbol	Parameter	Ratings	Unit
VGSO	Gate to sourcebreakdown voltage	-15	V
VGDO	Gate to drain breakdown voltage	-15	V
ID	Drain current	3000	mA
IGR	Reverse gate current	-10	mA
IGF	Forward gate current	21	mA
PT	Total power dissipation	18.7	W
Tch	Channel temperature	175	°C
Tstg	Storage temperature	-65 to +175	°C

Fig.1**Electrical characteristics** (Ta=25°C)

Symbol	Parameter	Test conditions	Limits			Unit
			Min.	Typ.	Max.	
IDSS	Saturated drain current	VDS=3V,VGS=0V	-	2400	3000	mA
VGS(off)	Gate to source cut-off voltage	VDS=3V,ID=10mA	-1	-3	-5	V
gm	Transconductance	VDS=3V,ID=800mA	-	1000	-	mS
Po	Output power	VDS=10V,ID=800mA,f=1.9GHz	35.0	36.5	-	dBm
η_{add}	Power added Efficiency	Pin=23dBm	-	50	-	%
GLP	Linear Power Gain	VDS=10V,ID=800mA,f=1.9GHz	13.0	14.5	-	dB
Rth(ch-c)	Thermal Resistance *1	Δ Vf Method	-	5	8	°C/W

*1:Channel to case / Above parameters, ratings, limits are subject to change.

MGF0915A TYPICAL CHARACTERISTICS

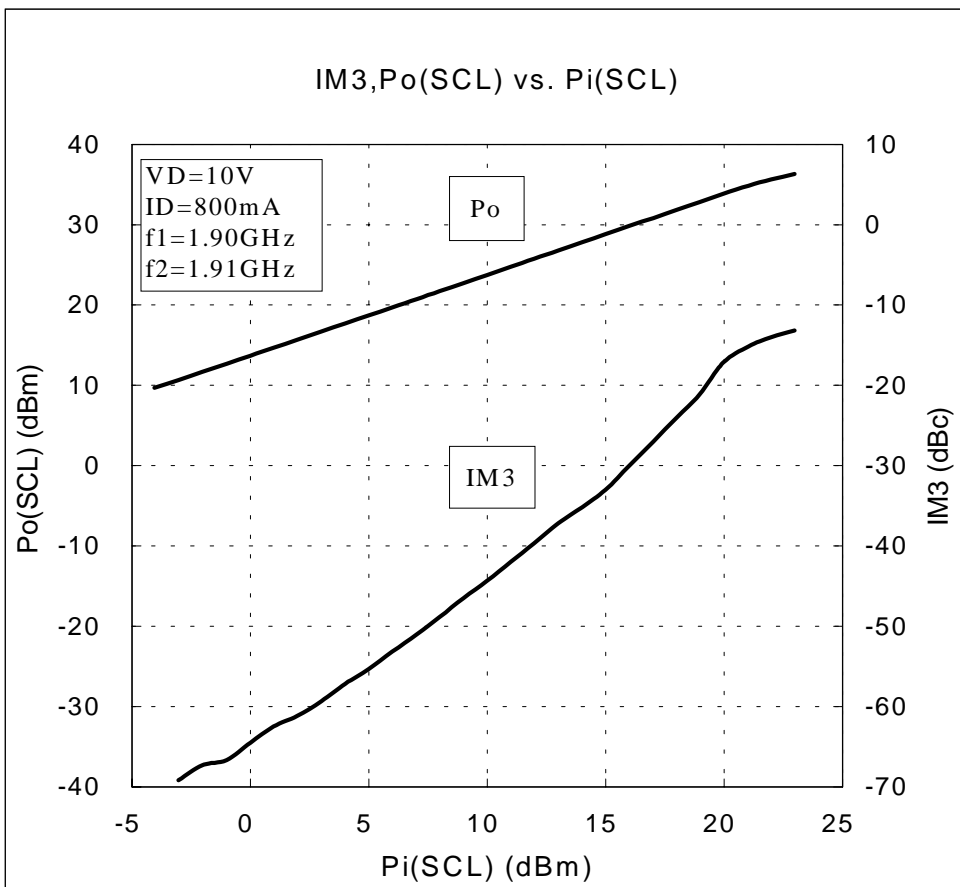
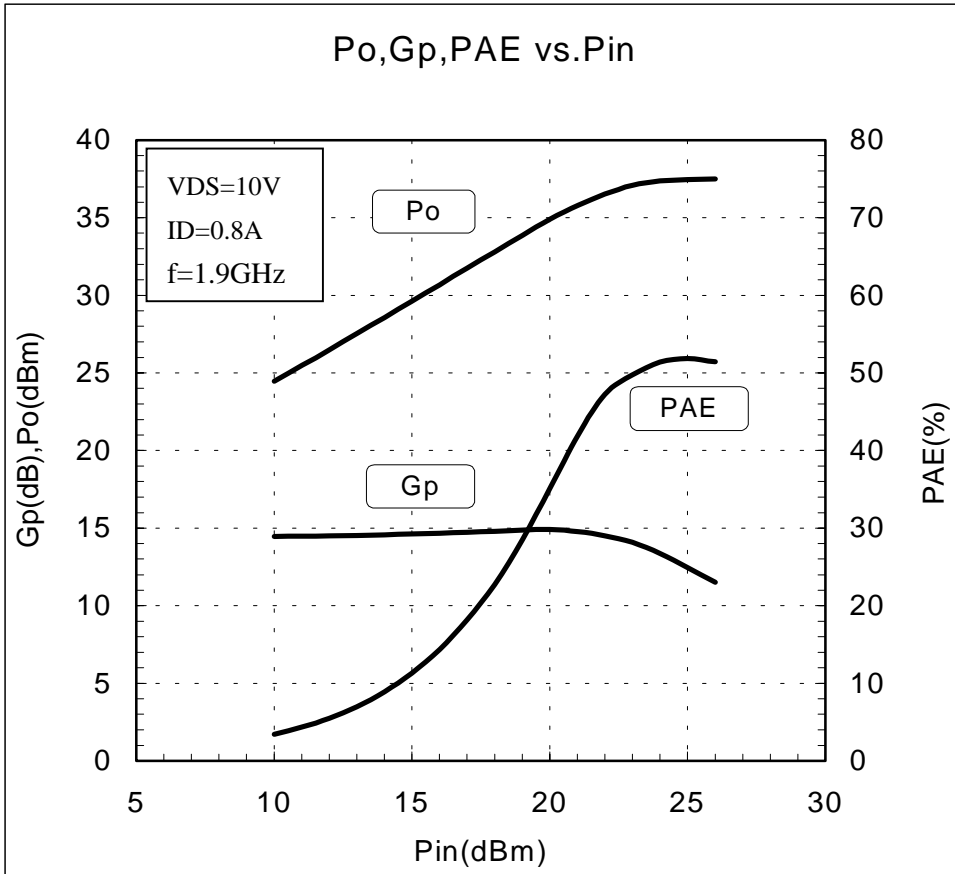

MGF0915A S PARAMETERS (Ta=25°C, VDS=10V, ID=800mA, Reference Plane see Fig.1)

freq. (MHz)	S11		S21		S12		S22		K	MAG/MSG (dB)
	(mag)	(ang)	(mag)	(ang)	(mag)	(ang)	(mag)	(ang)		
600	0.948	-145.92	4.852	99.38	0.013	24.42	0.721	-177.51	0.38	25.72
1000	0.947	-161.85	2.941	86.78	0.015	26.56	0.717	-178.09	0.63	22.92
1400	0.946	-168.94	2.144	77.11	0.015	28.76	0.719	-178.44	0.84	21.55
1800	0.946	-173.55	1.746	69.39	0.016	30.92	0.725	-178.66	0.94	20.38
2200	0.945	-176.72	1.456	62.91	0.017	32.93	0.732	-178.82	1.03	18.23
2600	0.944	-178.89	1.211	57.13	0.018	34.72	0.739	-178.94	1.14	16.00
3000	0.942	178.80	1.032	51.69	0.019	36.22	0.745	-179.06	1.27	14.25
3400	0.939	177.37	0.934	46.34	0.020	37.37	0.749	-179.19	1.34	13.19
3800	0.935	174.73	0.888	40.95	0.022	38.13	0.751	-179.32	1.34	12.59
4200	0.930	171.44	0.836	35.45	0.024	38.46	0.751	-179.44	1.38	11.75
4600	0.925	167.90	0.759	29.81	0.027	38.33	0.749	-179.56	1.43	10.58
5000	0.918	164.36	0.798	24.04	0.031	37.72	0.745	-179.67	1.27	10.96
5400	0.911	160.93	0.730	18.15	0.035	36.59	0.740	-179.78	1.33	9.76
5800	0.903	157.60	0.715	12.14	0.039	34.92	0.732	179.67	1.32	9.23
6200	0.894	154.31	0.708	6.01	0.045	32.68	0.724	177.54	1.26	8.90
6600	0.884	150.88	0.707	-0.28	0.052	29.84	0.713	175.25	1.20	8.65
7000	0.871	147.10	0.711	-6.80	0.060	26.34	0.702	172.45	1.15	8.38
7400	0.855	142.73	0.721	-13.66	0.069	22.15	0.688	169.39	1.12	8.06
7800	0.833	137.52	0.739	-20.98	0.081	17.18	0.671	166.53	1.09	7.75
8200	0.807	131.21	0.765	-28.93	0.094	11.37	0.651	164.20	1.08	7.43
8600	0.778	123.58	0.802	-37.70	0.110	4.61	0.624	162.51	1.04	7.36
9000	0.748	114.45	0.849	-47.48	0.129	-3.21	0.590	161.19	1.00	8.18
9400	0.717	103.71	0.905	-58.48	0.152	-12.23	0.545	159.72	0.96	7.75
9800	0.688	91.34	0.964	-70.88	0.179	-22.60	0.487	157.44	0.93	7.31
10200	0.671	77.41	1.023	-84.83	0.211	-34.51	0.410	153.88	0.90	6.86
10600	0.672	62.12	1.072	-100.40	0.248	-48.17	0.311	149.13	0.86	6.36
11000	0.697	45.82	1.100	-117.62	0.293	-63.82	0.184	144.37	0.81	5.75
11400	0.746	29.03	1.095	-136.37	0.326	-81.74	0.021	-179.00	0.79	5.26
11800	0.812	12.43	1.038	-156.40	0.346	-102.24	0.194	-81.10	0.79	4.77
12200	0.877	-3.09	0.913	-177.29	0.346	-125.67	0.404	-95.22	0.79	4.21

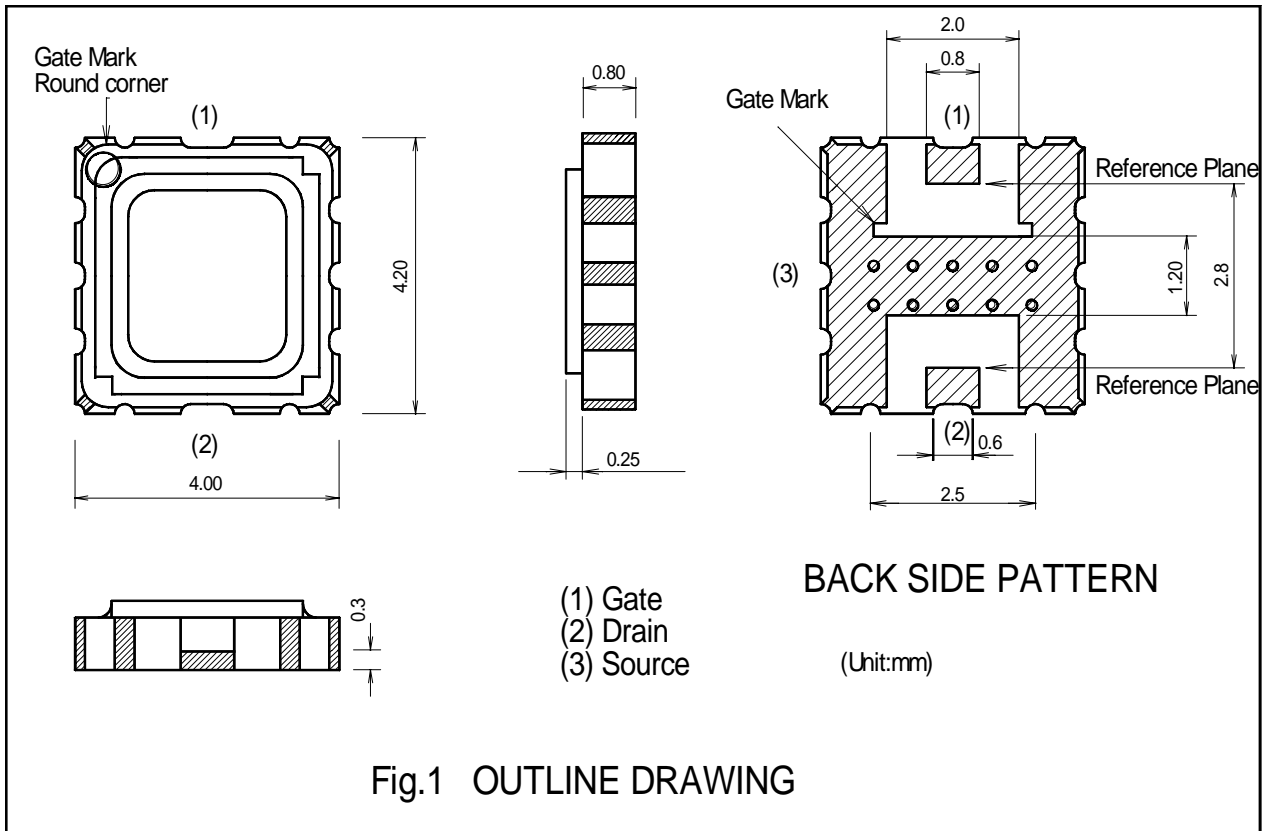
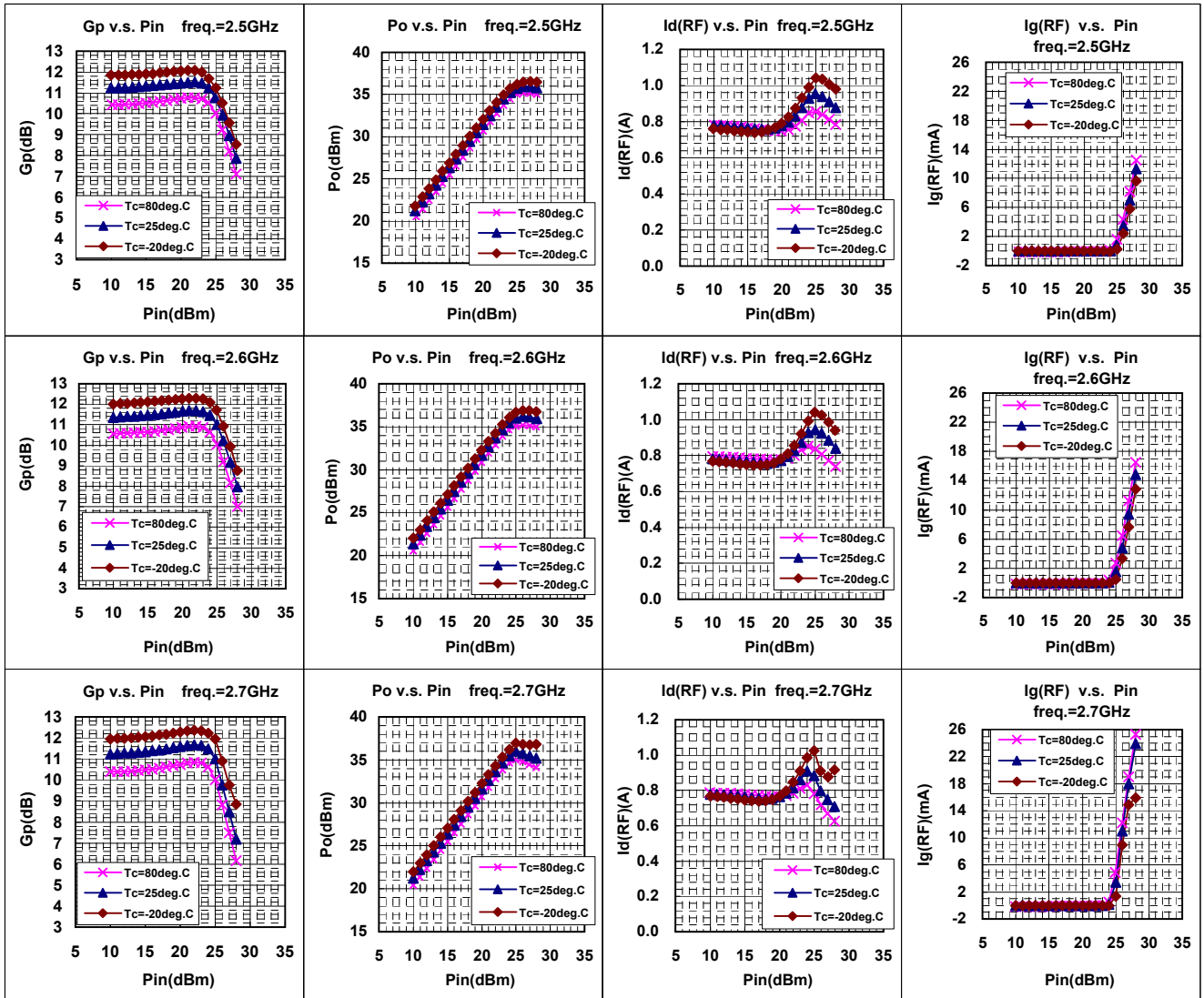

Fig.1 OUTLINE DRAWING

MGF0915A RF TEST DATA(CW) VD=10V,Idq=0.8A
Gp,Po,Id(RF),I_g(RF) v.s. Pin



MGF0915A RF TEST DATA(CW)

Gp,Po,Id(RF),Ig(RF) v.s. Pin

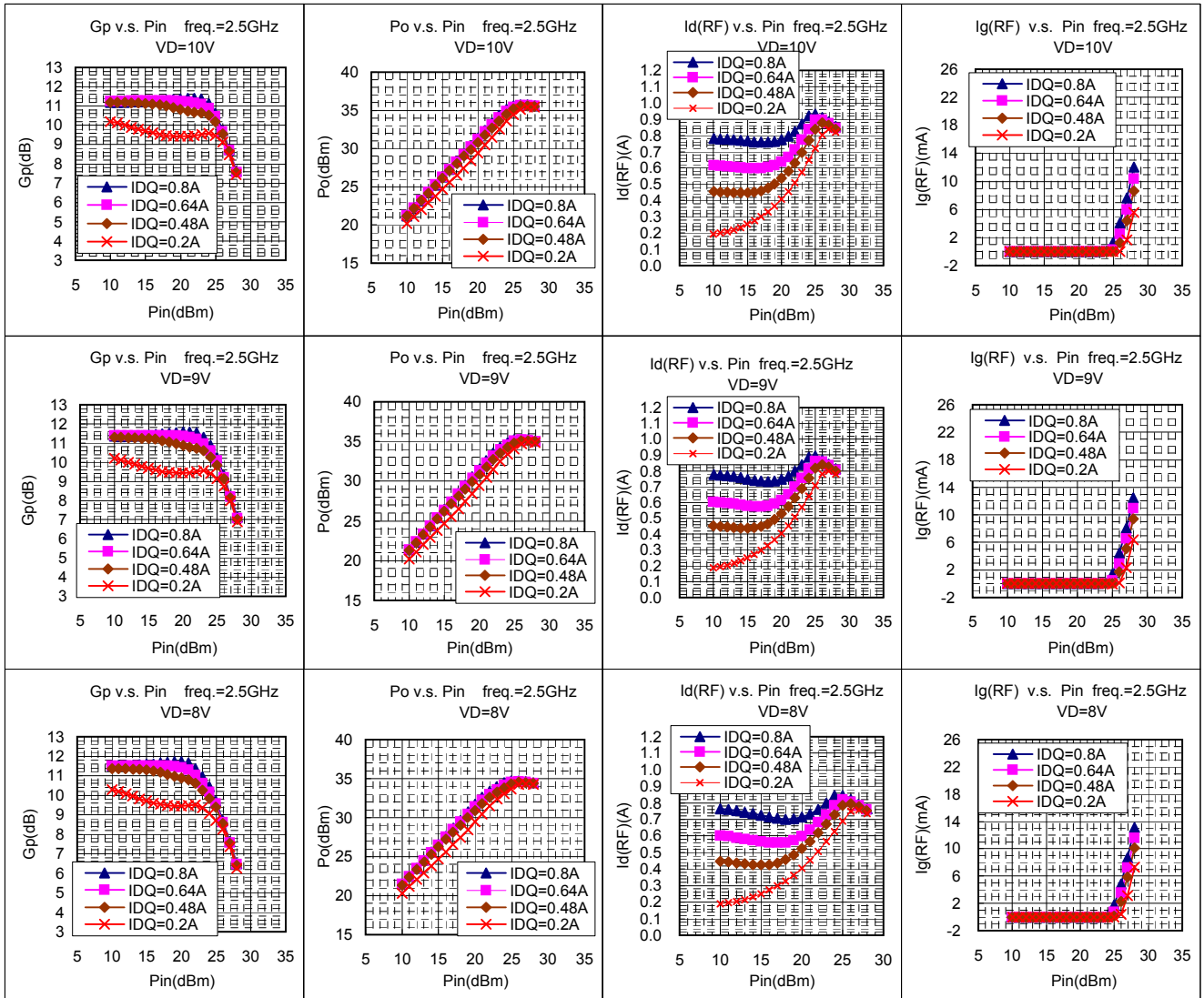

MGF0915A RF TEST DATA(CW)

Gp,Po,Id(RF),Iq(RF) v.s. Pin

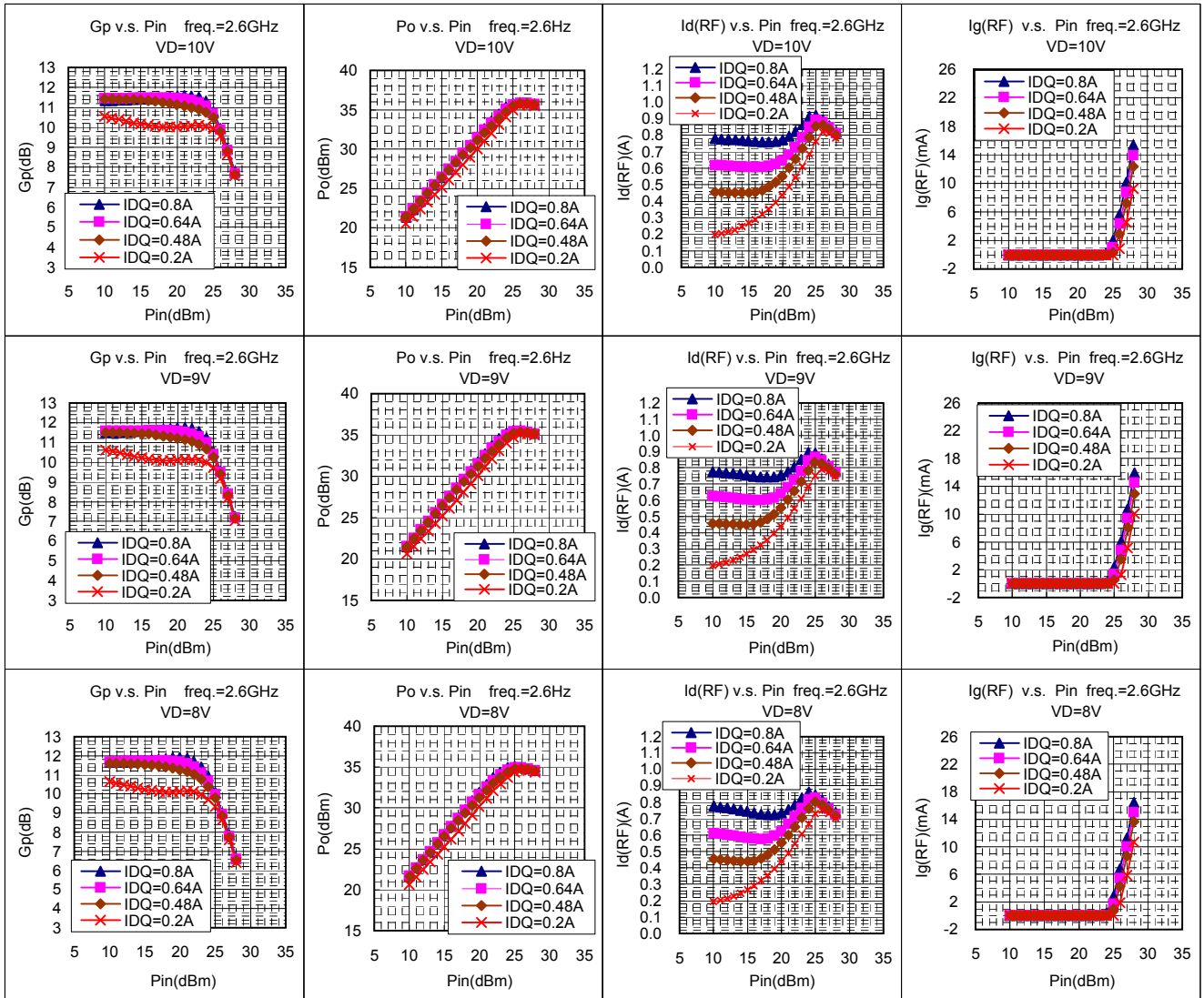

MGF0915A RF TEST DATA(CW)

Gp,Po,Id(RF),Iq(RF) v.s. Pin

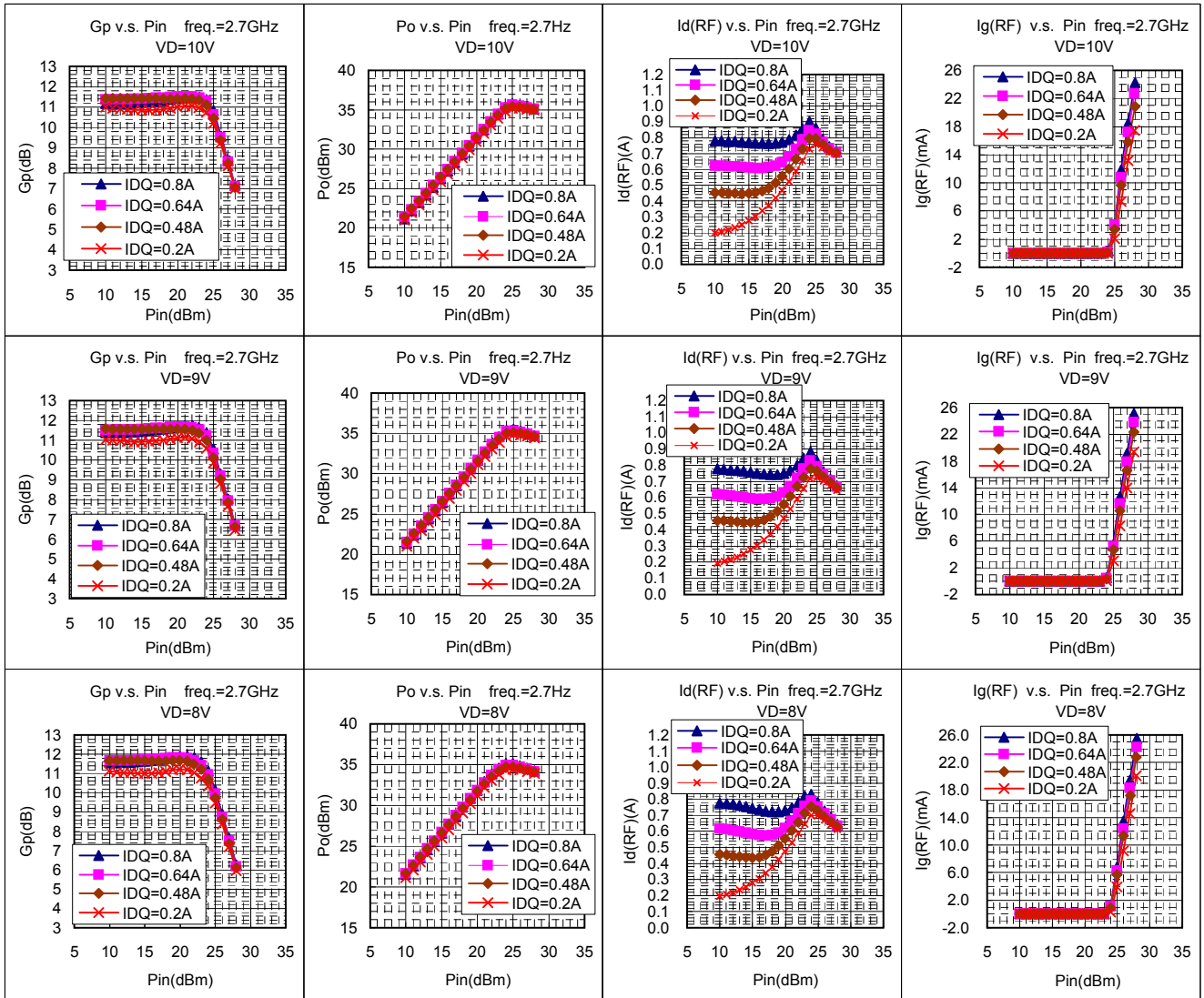

MGF0915A RF TEST DATA(CW)

Gp,Po,Id(RF),I_g(RF) v.s. Pin

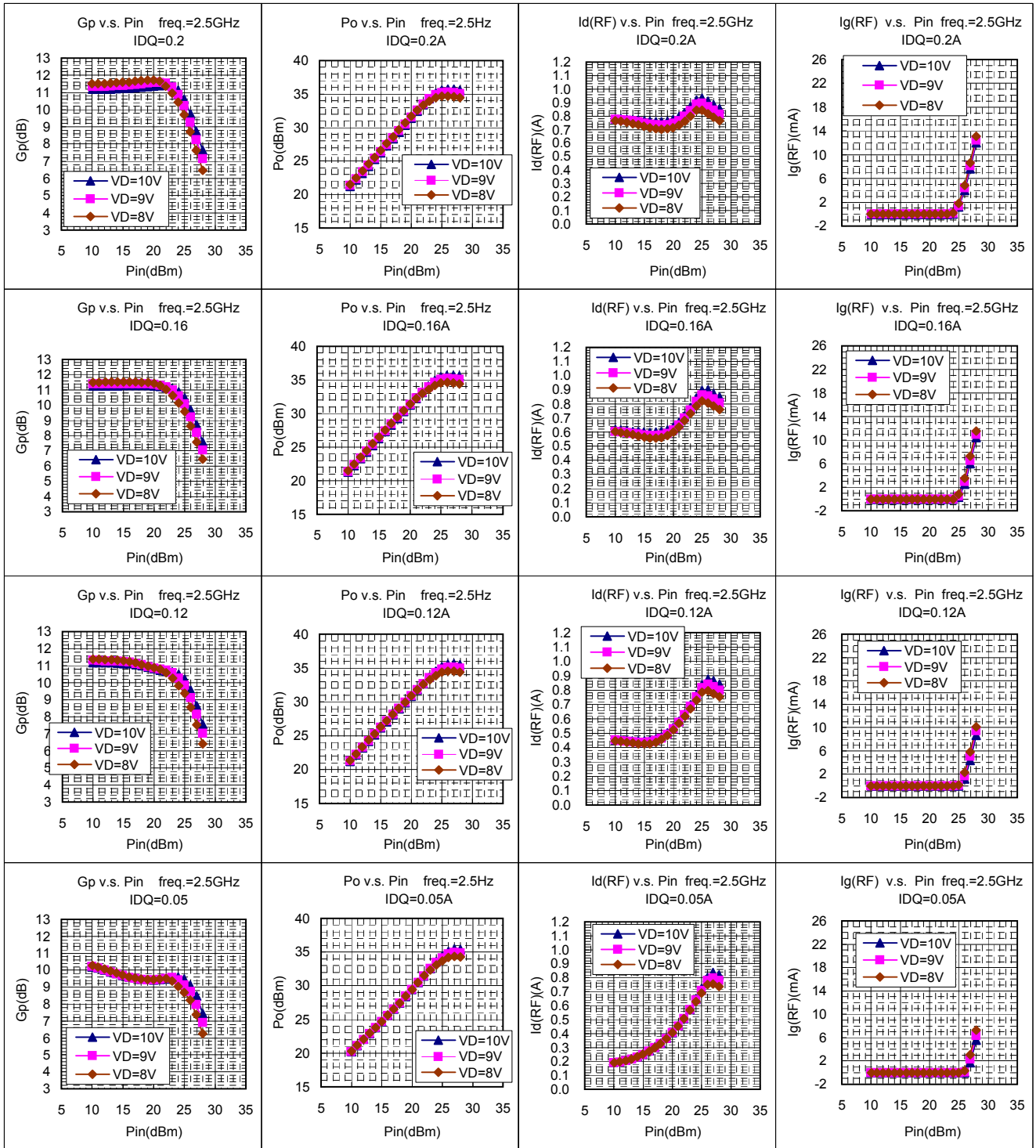

MGF0915A RF TEST DATA(CW)

Gp,Po,Id(RF),I_g(RF) v.s. Pin

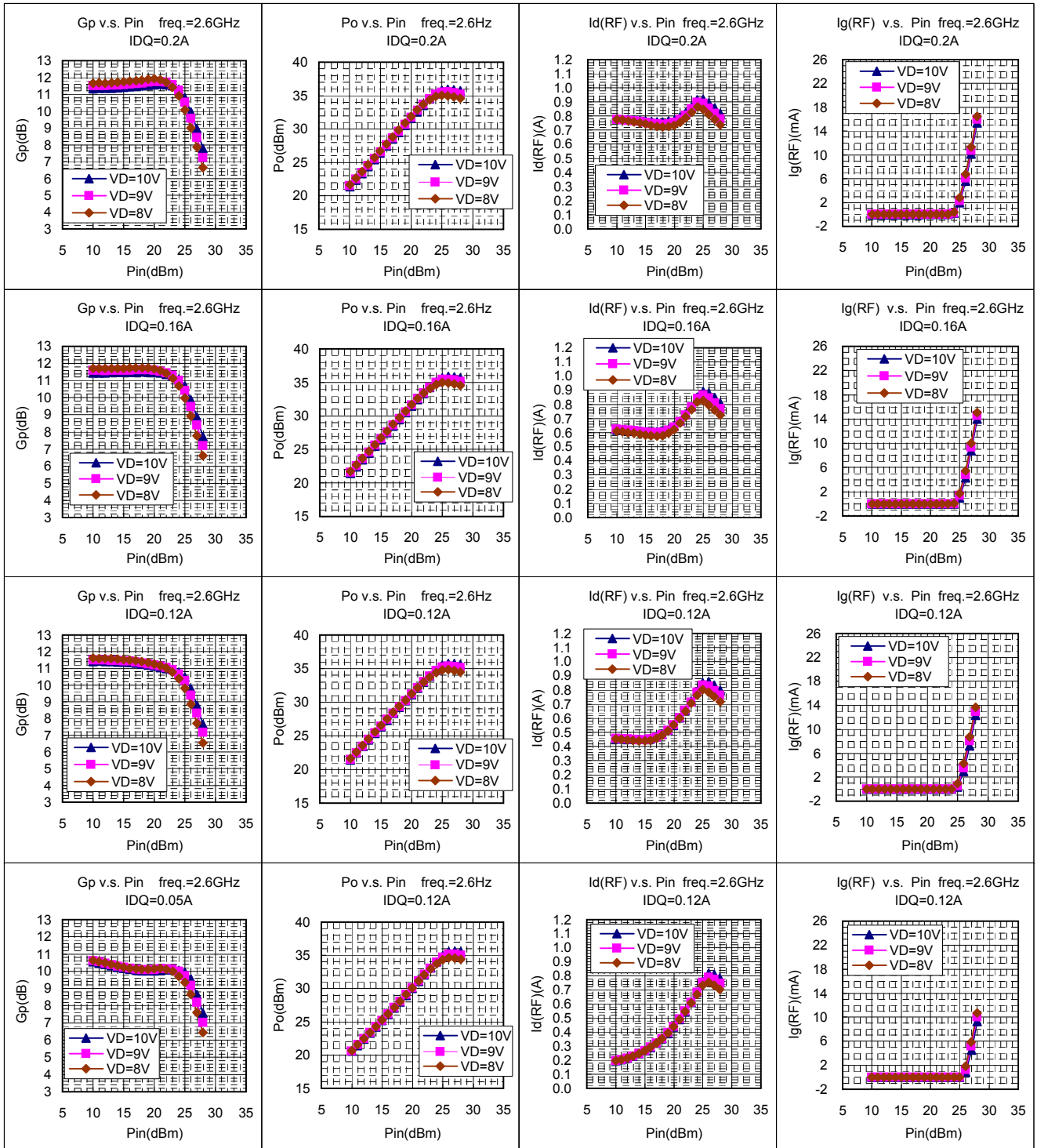

MGF0915A RF TEST DATA(CW)

Gp,Po,Id(RF),I_g(RF) v.s. Pin

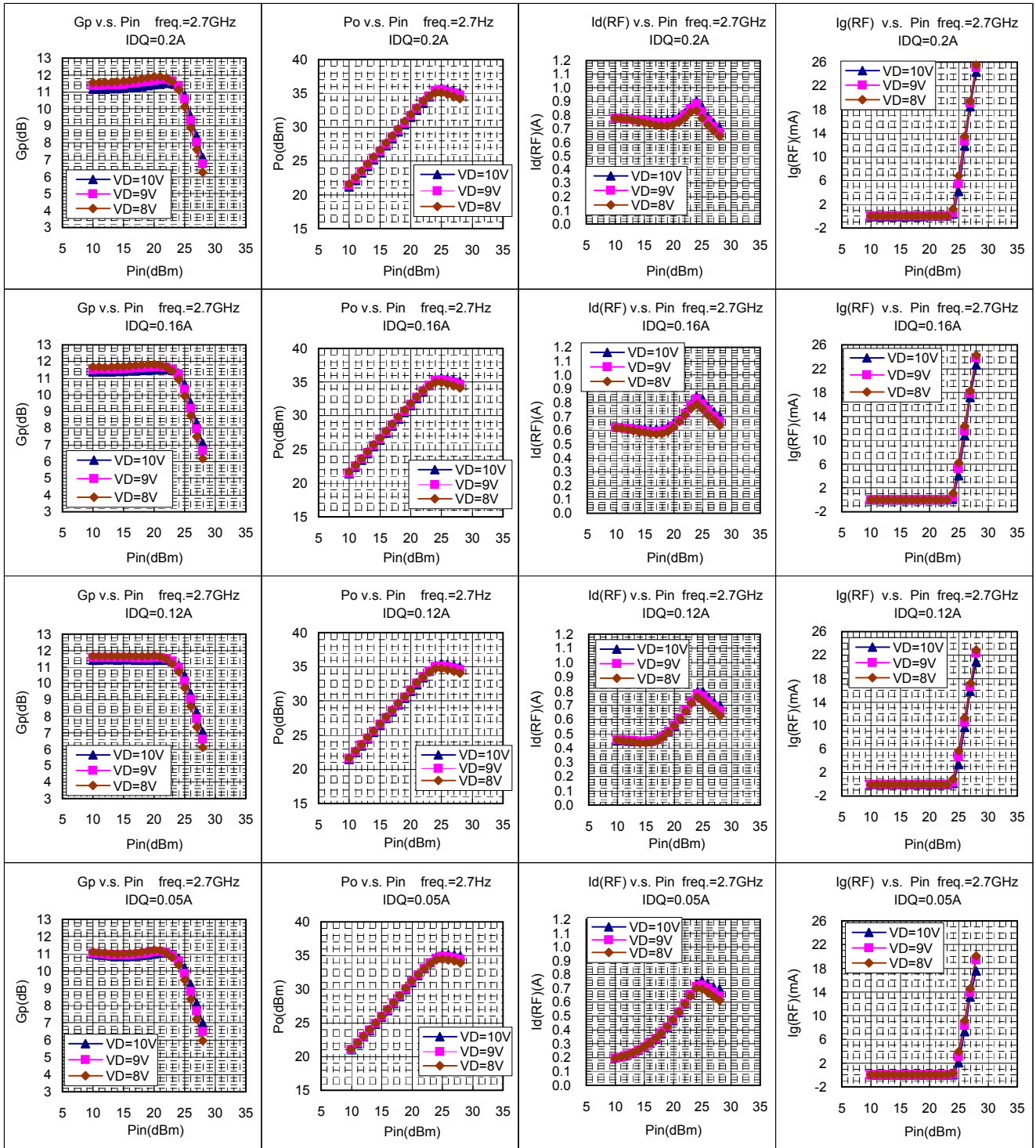

MGF0915A RF TEST DATA(W-CDMA) VD=10V,Idq=0.8A
ACLR v.s. Po 3GPP TEST MODEL1 64ch's Single Signal

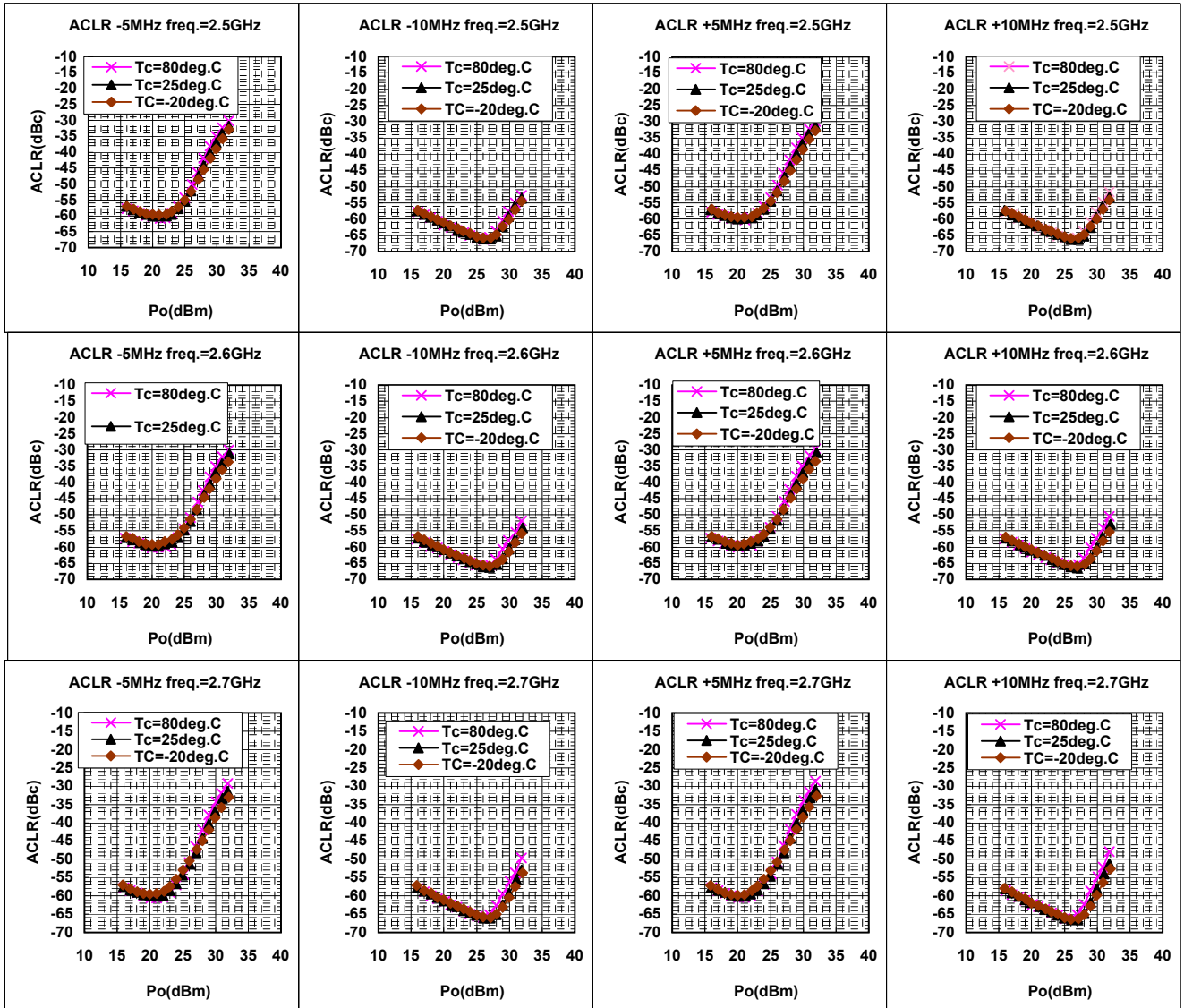

MGF0915A RF TEST DATA(W-CDMA)
ACLR v.s. Po 3GPP TEST MODEL1 64ch's Single Signal

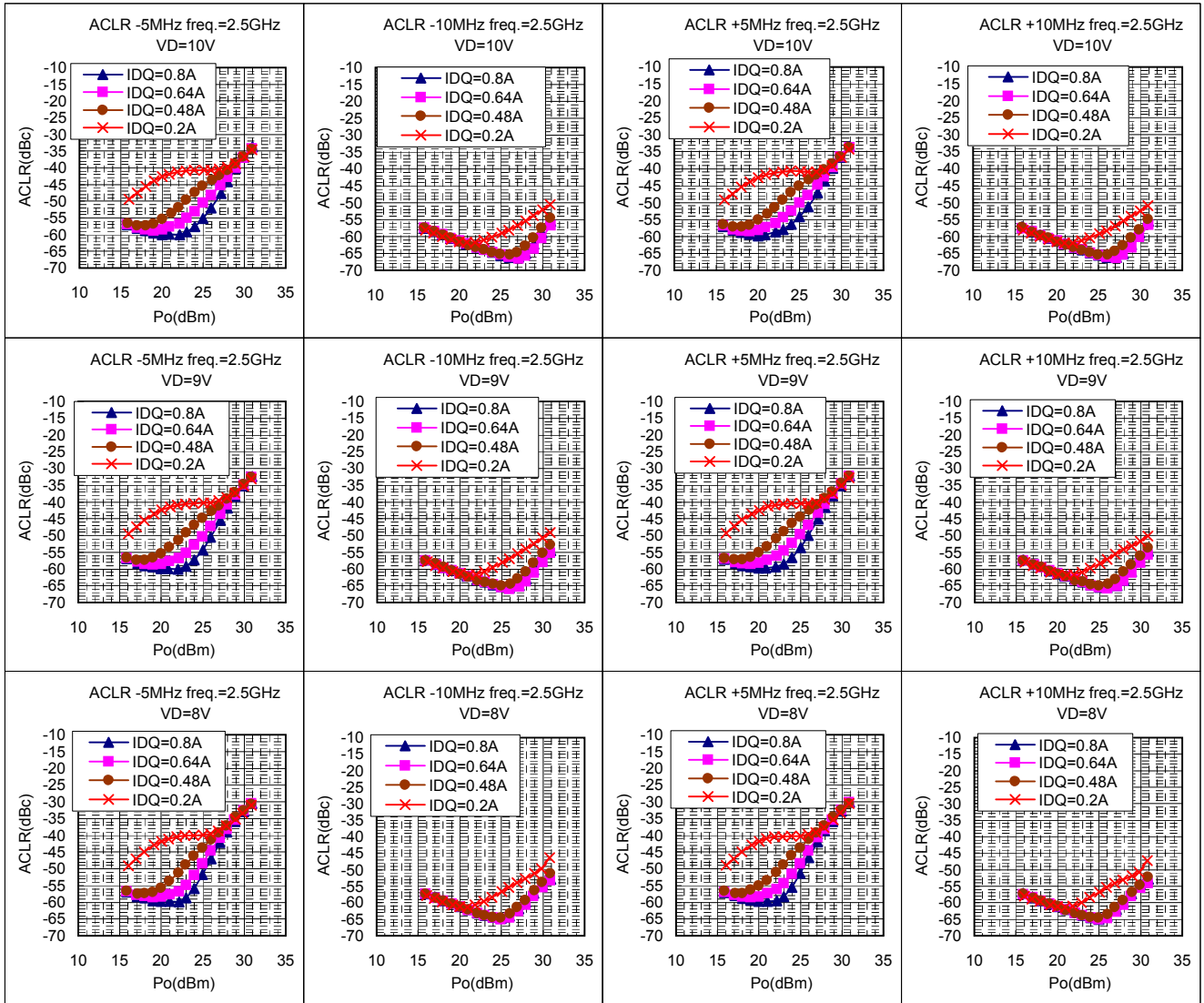

MGF0915A RF TEST DATA(W-CDMA)
ACLR v.s. Po 3GPP TEST MODEL1 64ch's Single Signal

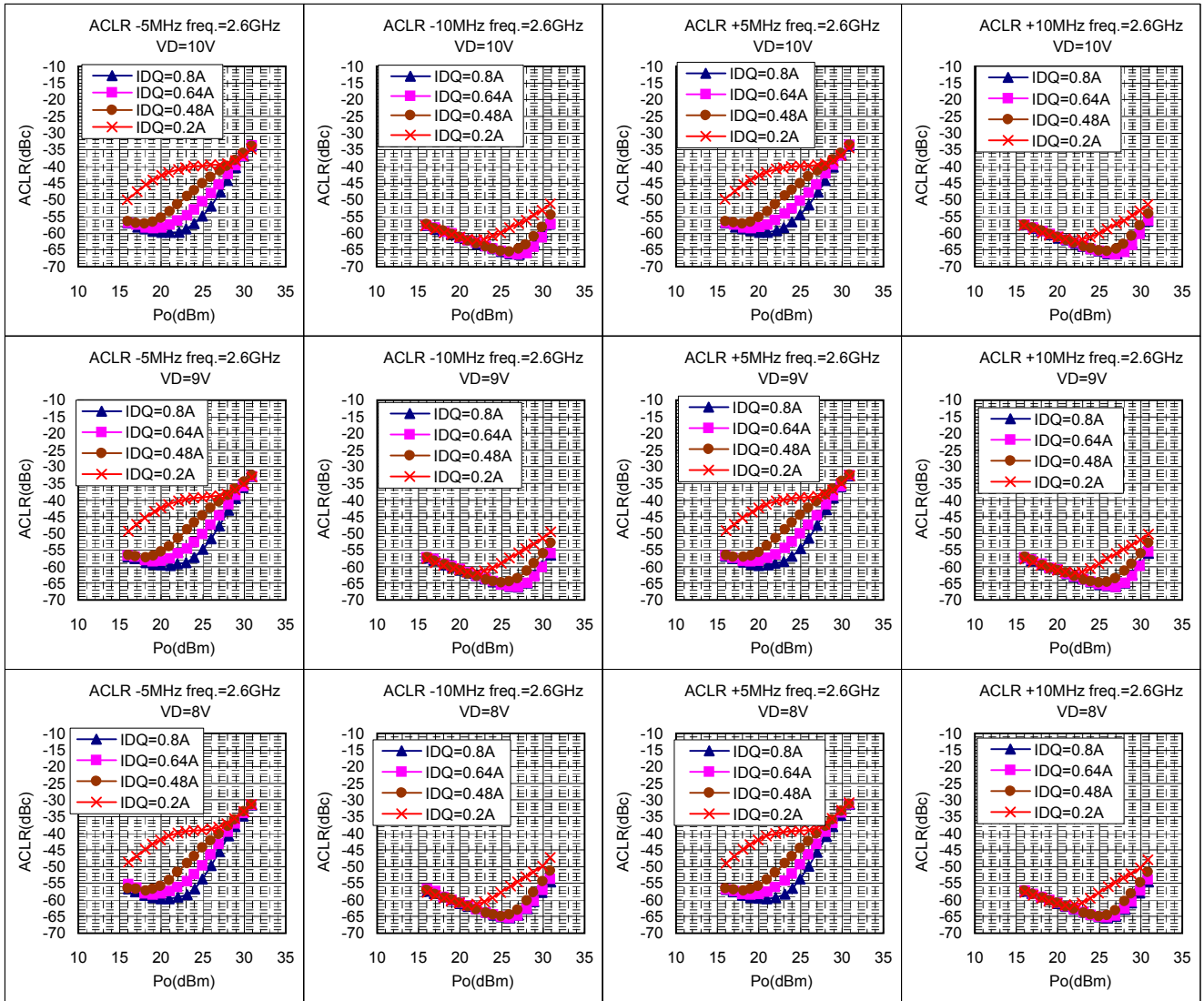

MGF0915A RF TEST DATA(W-CDMA)
ACLR v.s. Po 3GPP TEST MODEL1 64ch's Single Signal

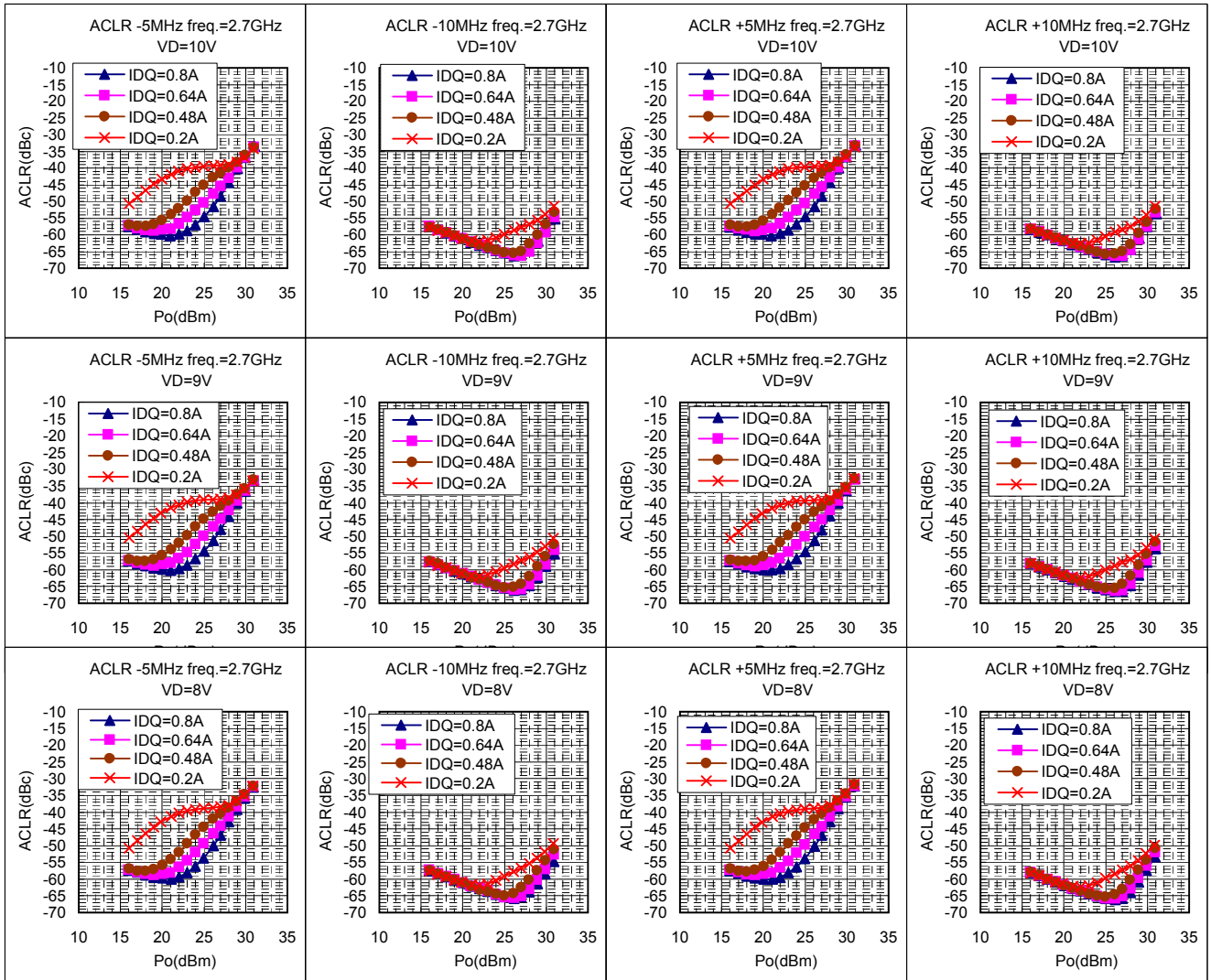

MGF0915A RF TEST DATA(W-CDMA)

ACLR v.s. Po 3GPP TEST MODEL1 64ch's Single Signal

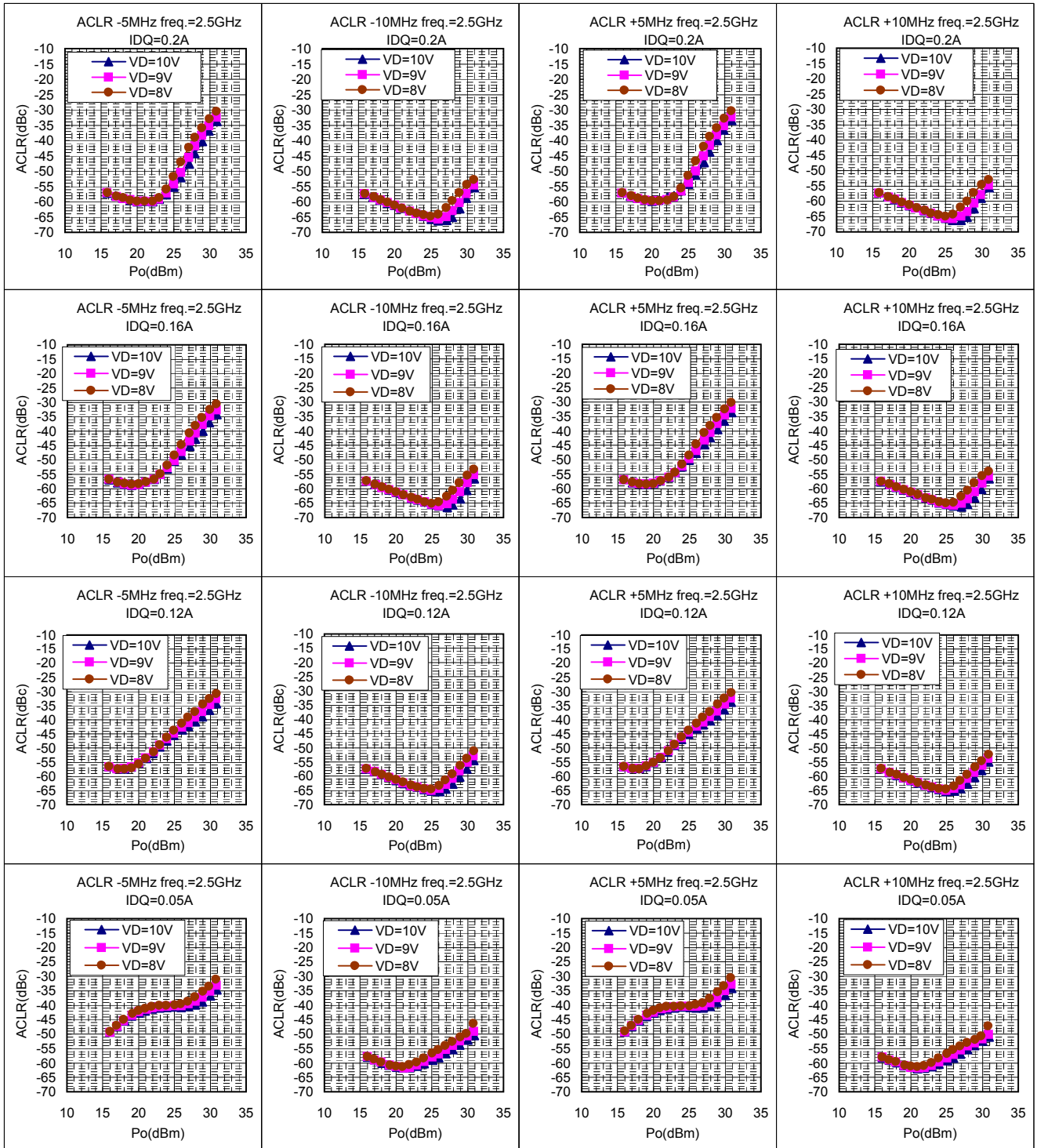

MGF0915A RF TEST DATA(W-CDMA)

ACLR v.s. Po 3GPP TEST MODEL1 64ch's Single Signal

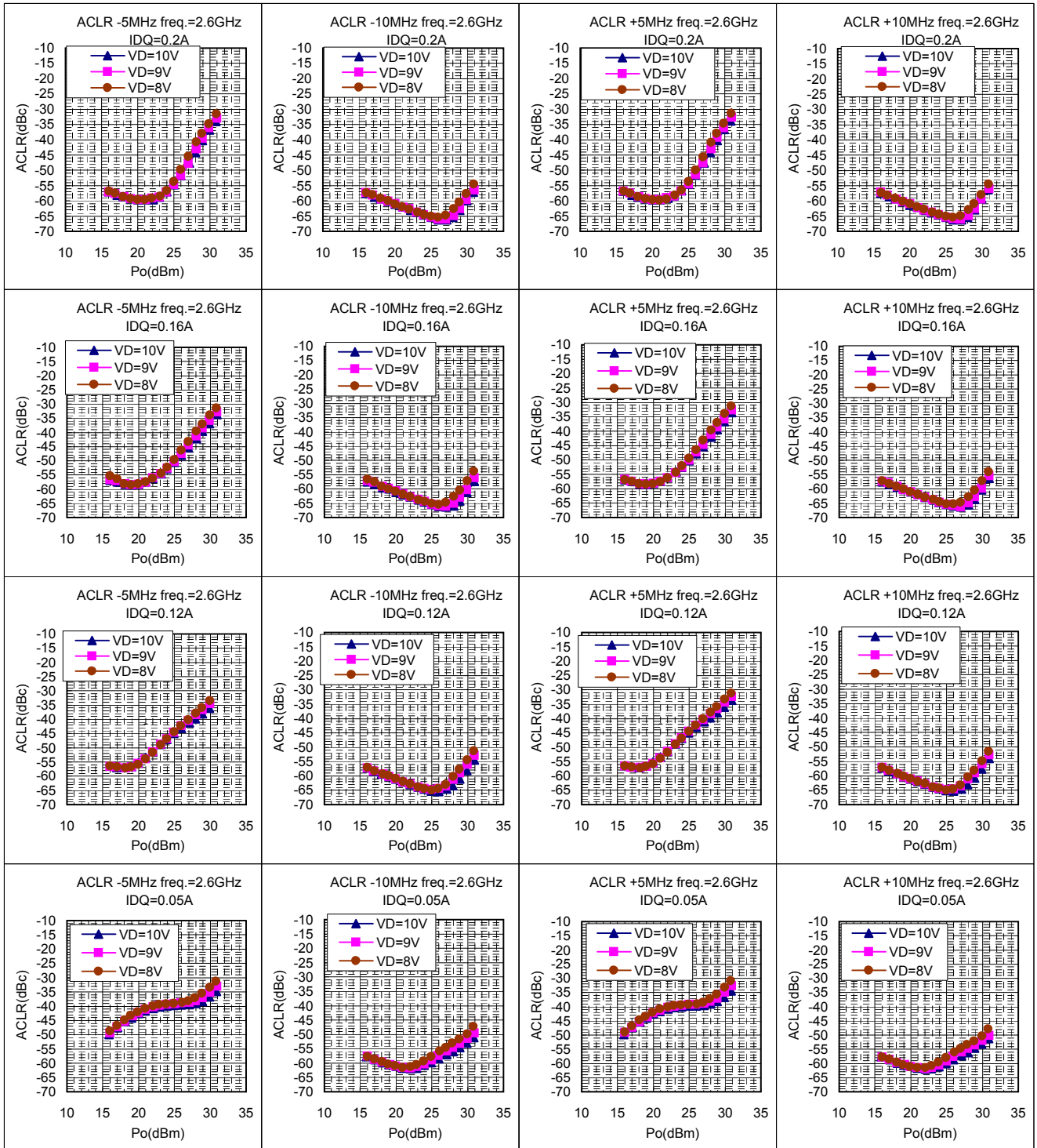

MGF0915A RF TEST DATA(W-CDMA)

ACLR v.s. Po 3GPP TEST MODEL1 64ch's Single Signal

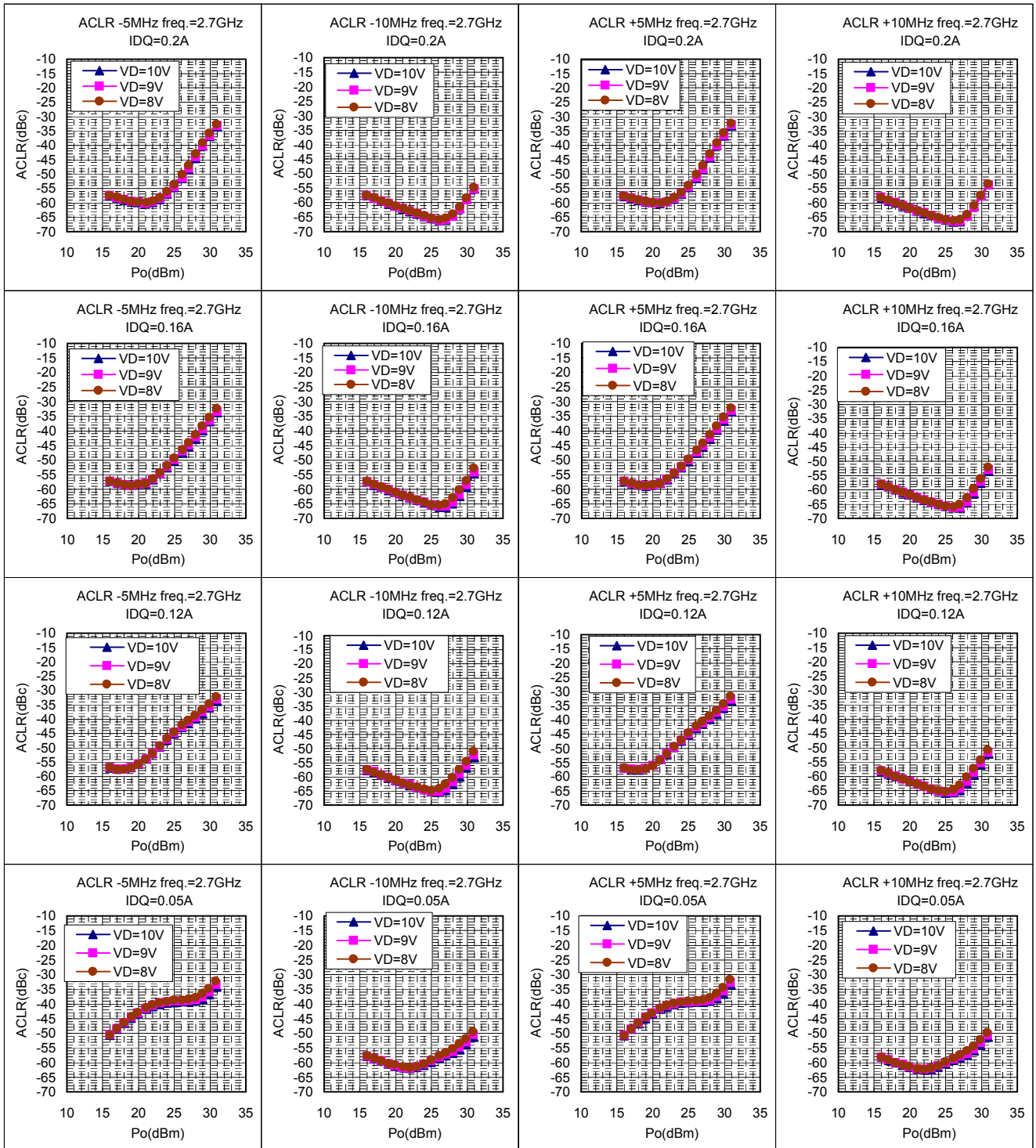

MGF0915A RF TEST DATA VD=10V, Idq=0.8A
IM3,IM5 v.s. Pin

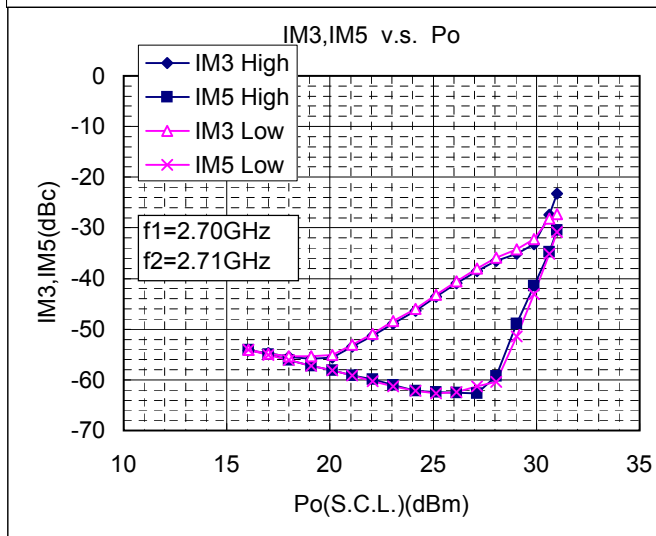
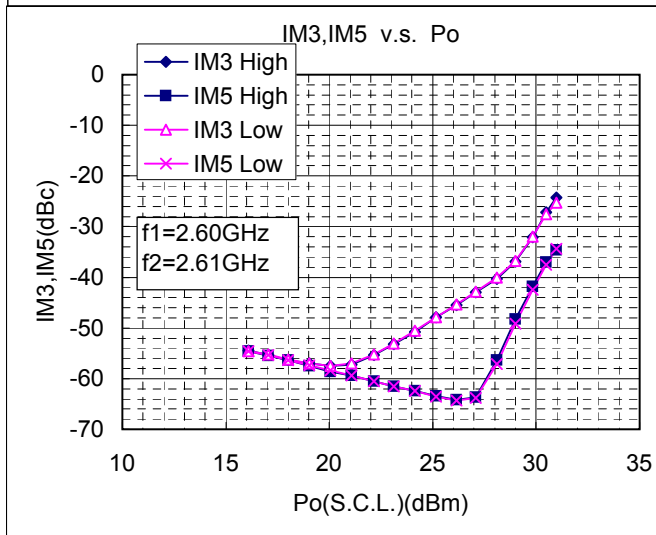
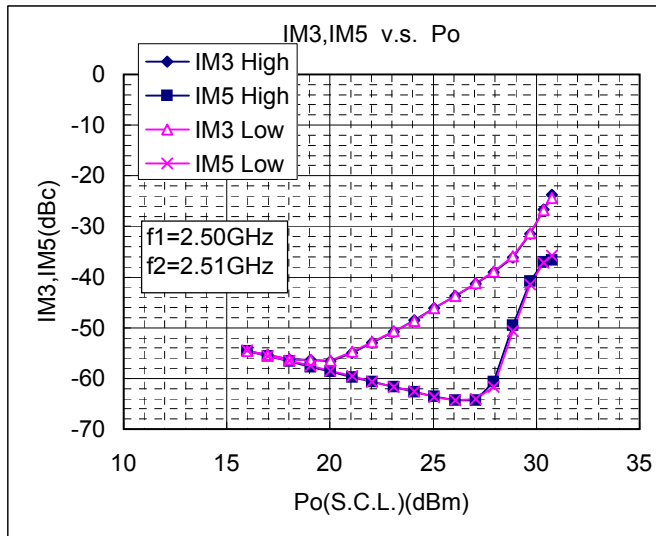

MGF0915A TEST FIXTURE $f=2.6\text{GHz}$

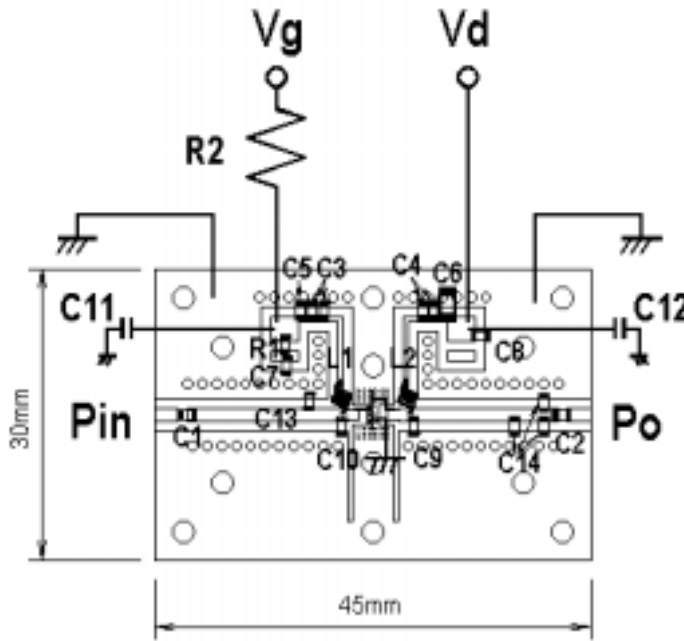

- C1,C2,C3,C4=20pF
- C5,C7,C8=1000pF
- C9,C10=2pF
- C11,C12=47uF
- C6=4.7uF
- C13,C14=0.5pF
- L1,L2= 12nH
- R1=51ohm
- R2=100ohm

Board material:FR4 Thickness=0.8(mm)
 Specific dielectric constant=4.4

MGF0915A RF TEST DATA(CW) VD=10V,Idq=0.8A

Gp,Po,Id(RF),I_g(RF) v.s. Pin

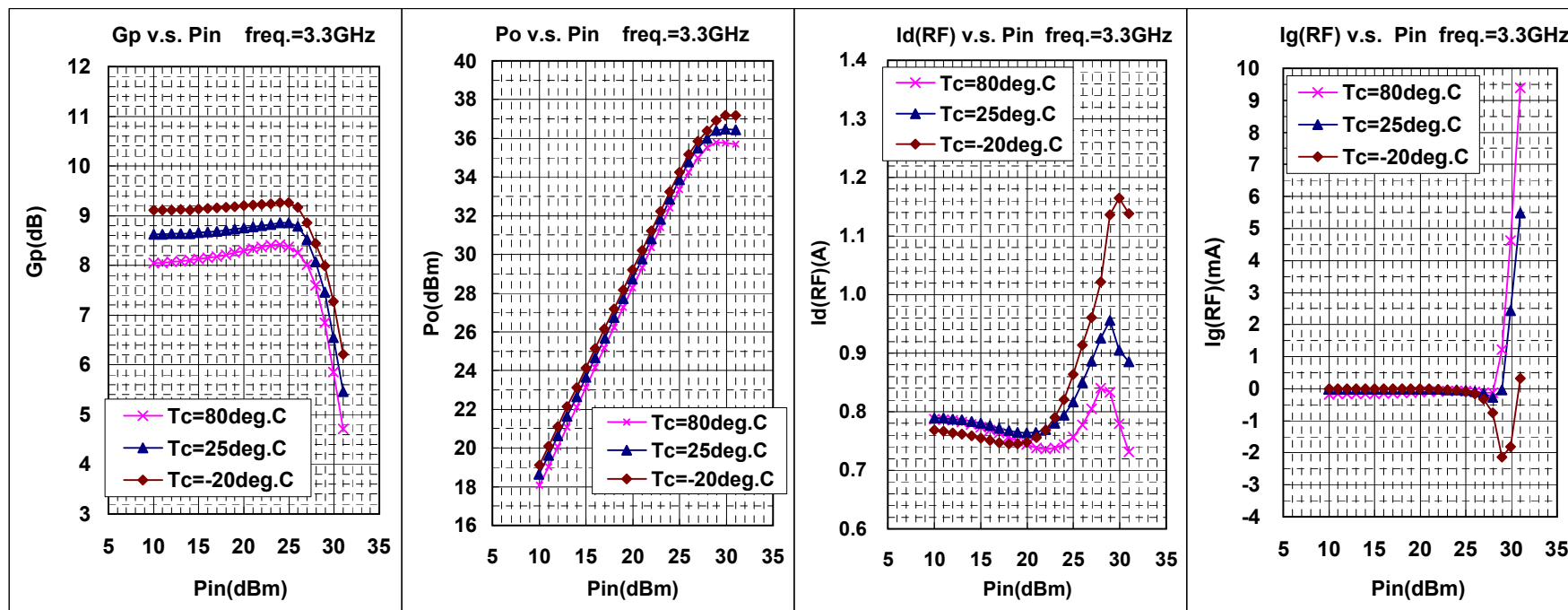

MGF0915A RF TEST DATA(CW)
Gp,Po,Id(RF),Ig(RF) v.s. Pin

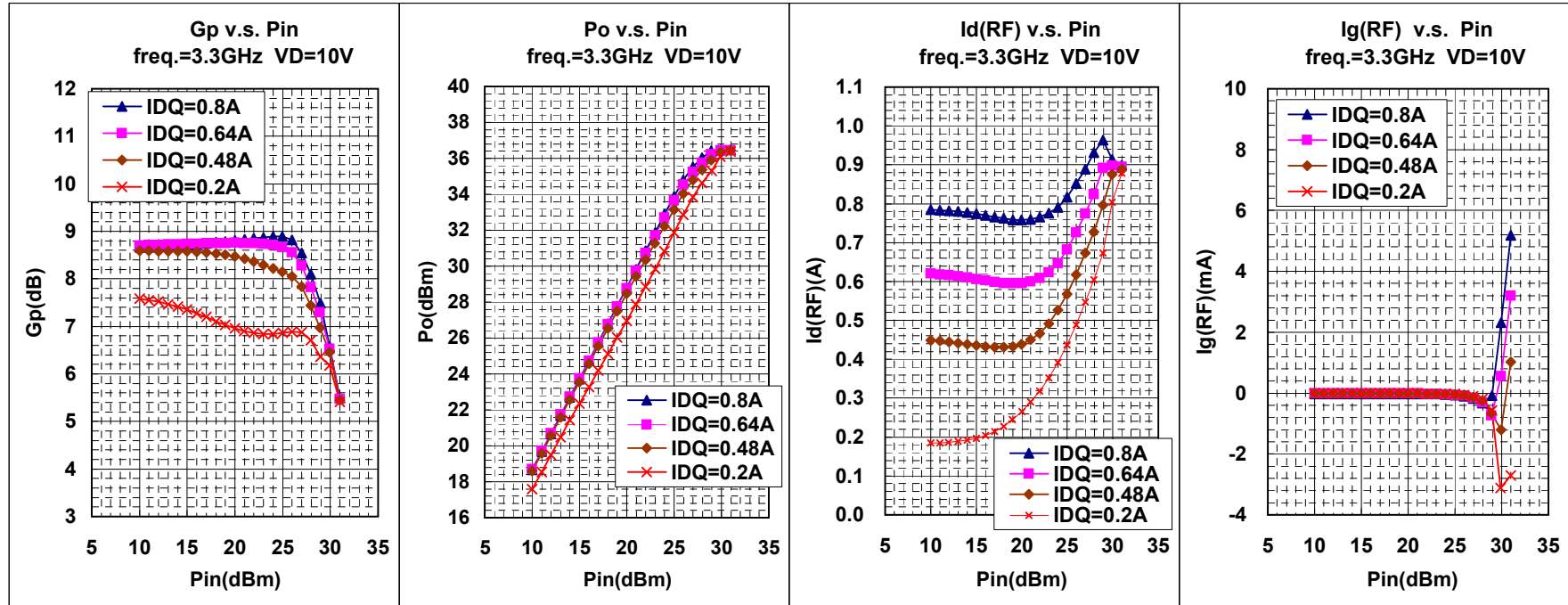

MGF0915A RF TEST DATA(CW)
Gp,Po,Id(RF),Ig(RF) v.s. Pin

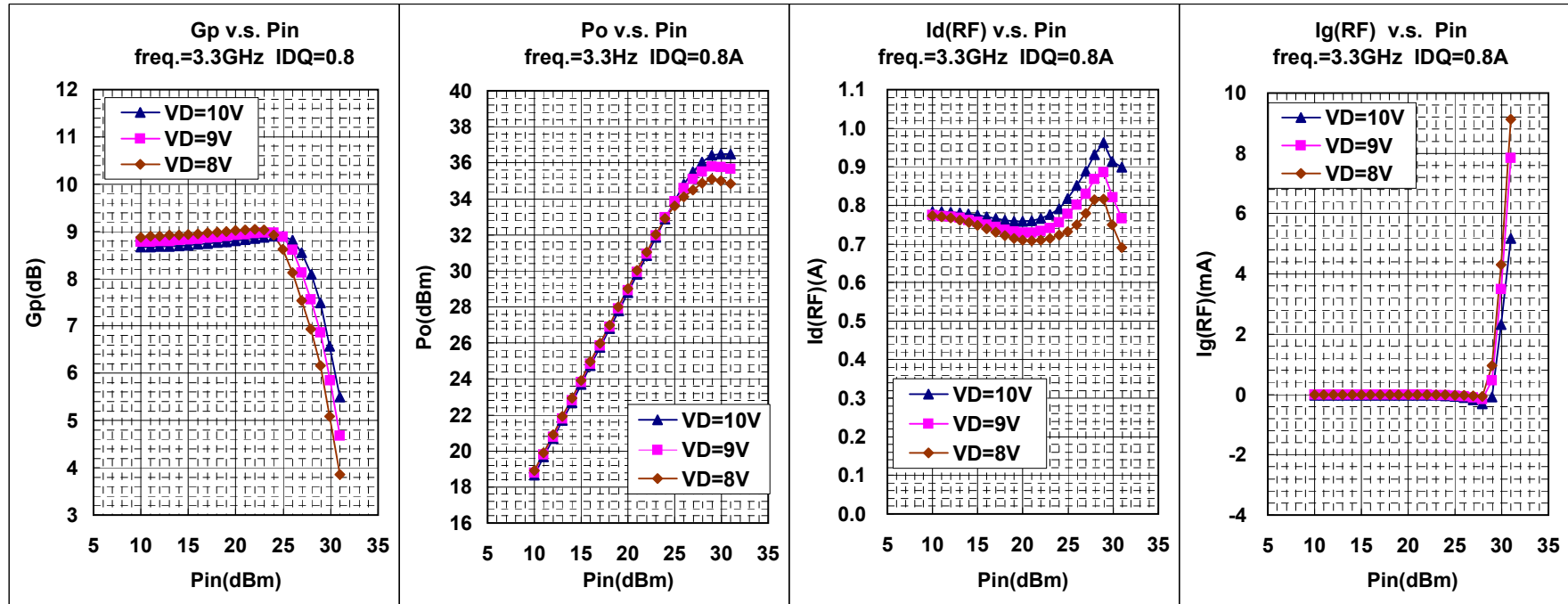

MGF0915A RF TEST DATA(W-CDMA) VD=10V,Idq=0.8A
 ACLR v.s. Po 3GPP TEST MODEL1 64ch's Single Signal

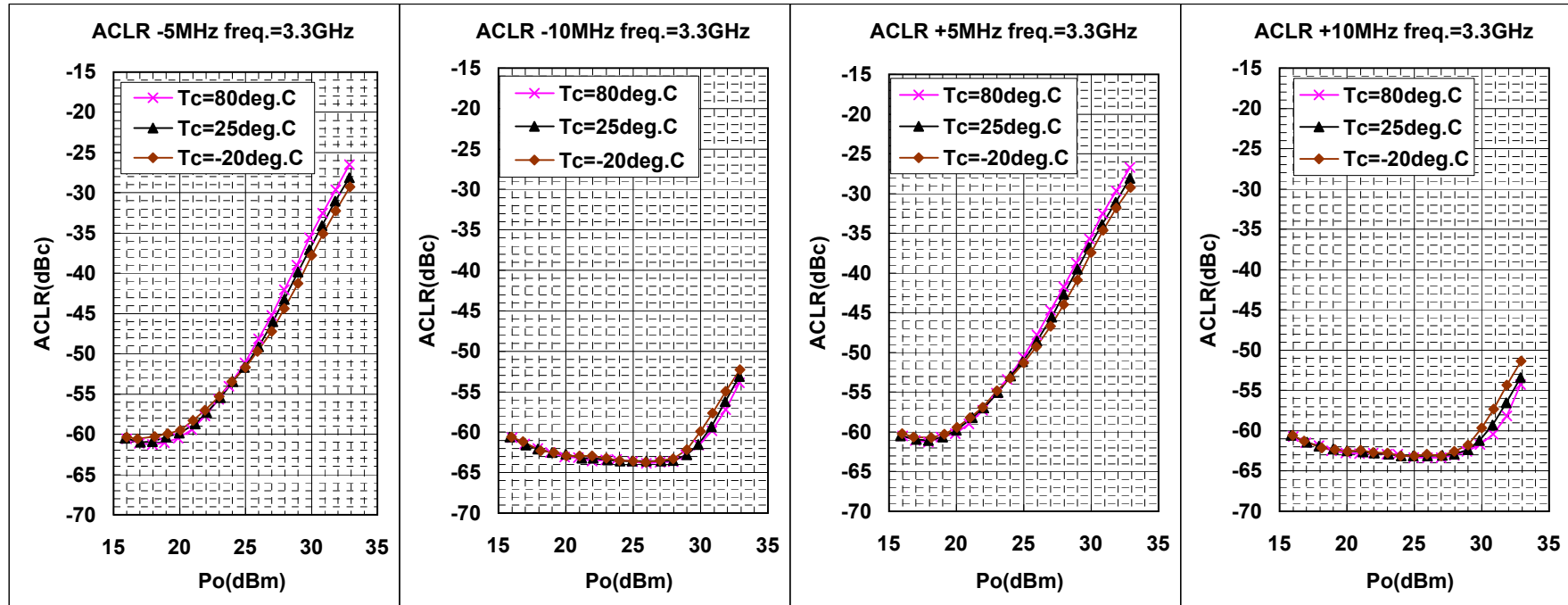

MGF0915A RF TEST DATA(W-CDMA)
ACLR v.s. Po 3GPP TEST MODEL1 64ch's Single Signal

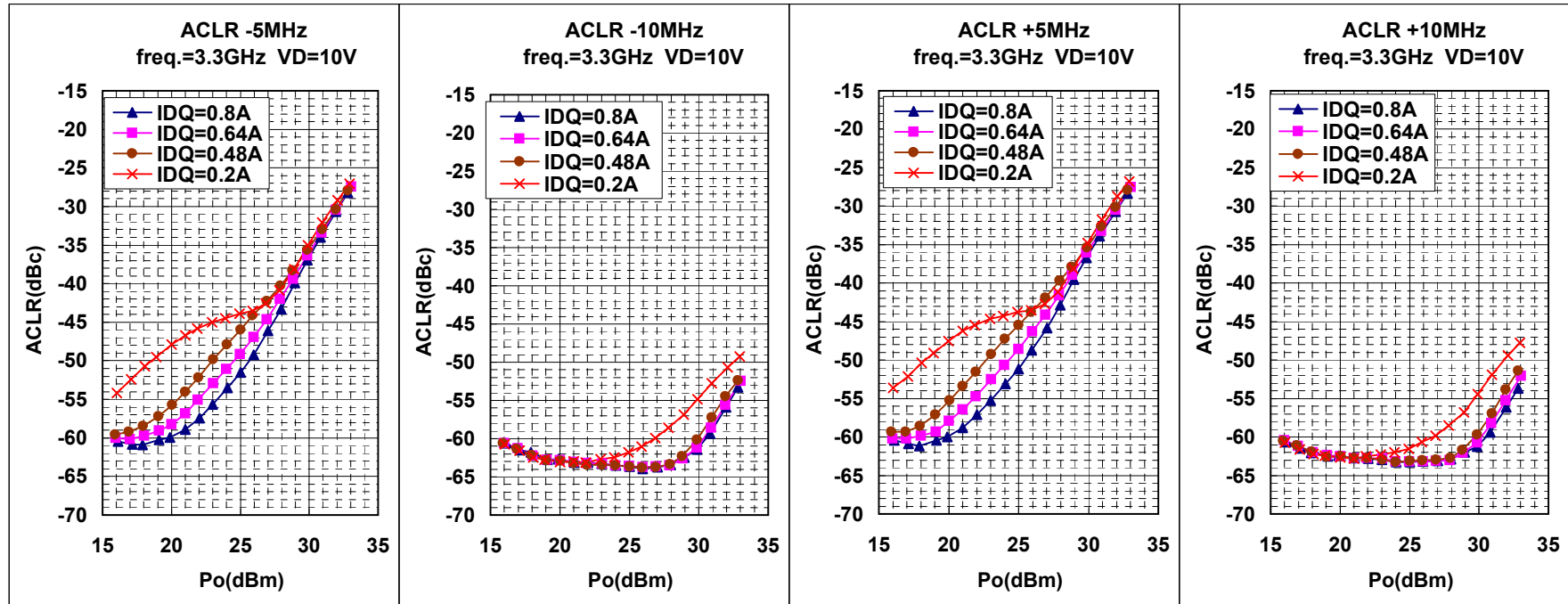

MGF0915A RF TEST DATA(W-CDMA)
ACLR v.s. Po 3GPP TEST MODEL1 64ch's Single Signal

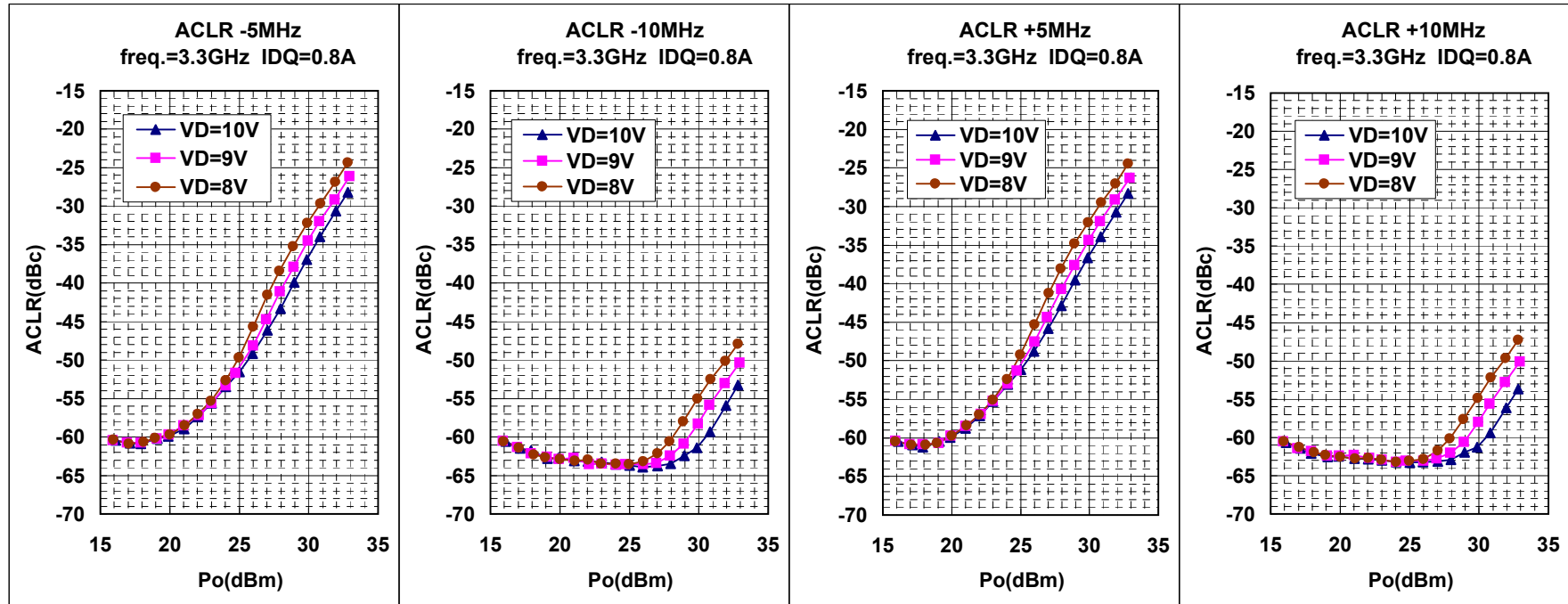

MGF0915A RF TEST DATA VD=10V,Idq=0.8A
IM3,IM5 v.s. Pin

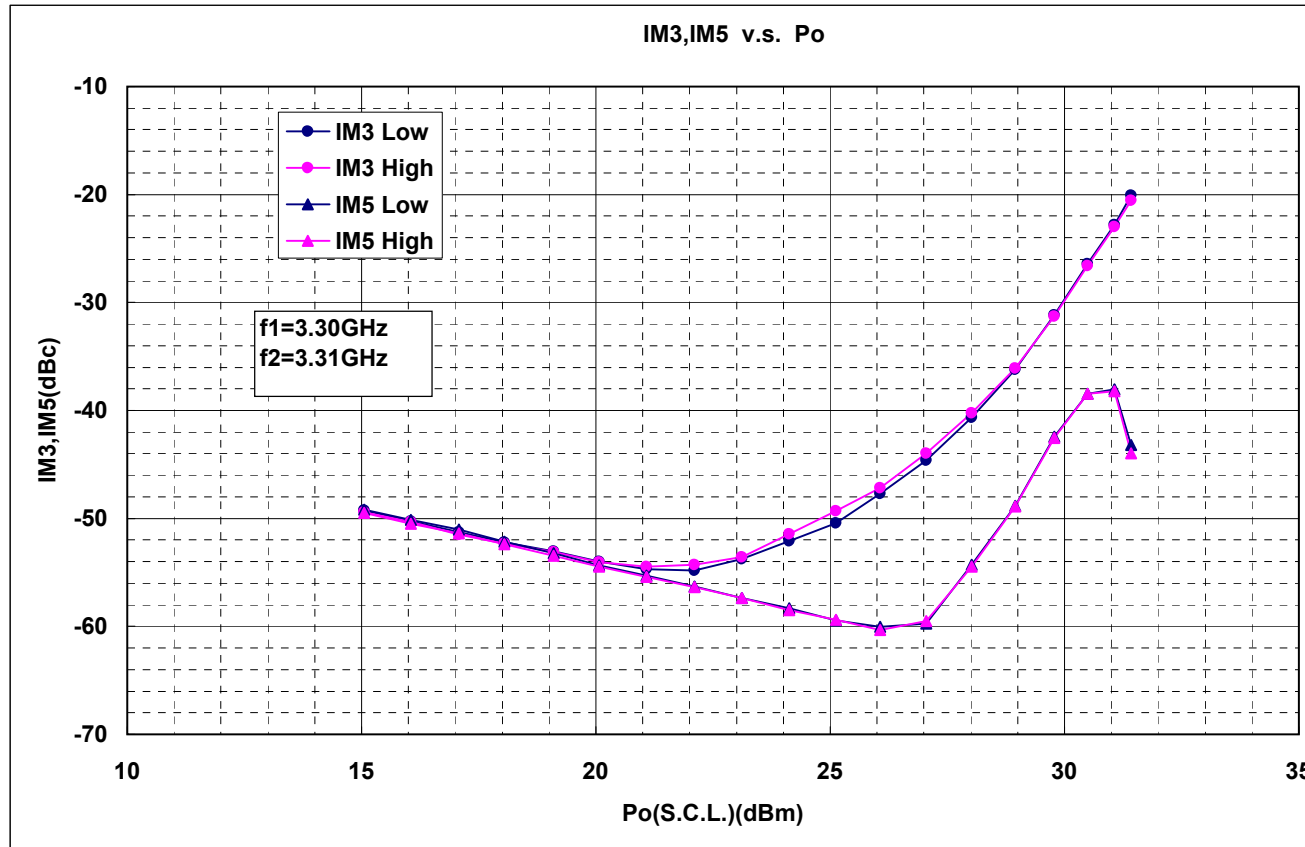

MGF0915A TEST FIXTURE $f=3.3\text{GHz}$

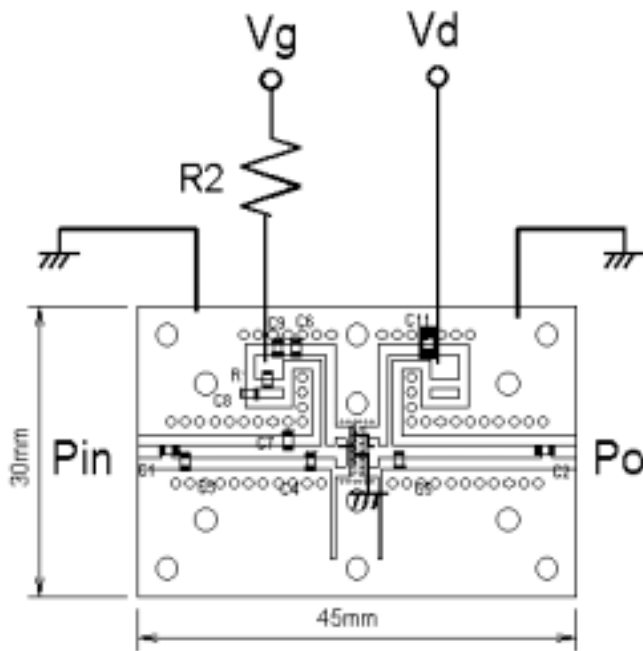

C1,C2=20pF
C3,C4,C5=1P
C6=22pF
C7=0.5pF
C8,C9=1000pF
C11=4.7uF
R1=51ohm
R2=100ohm

Board material:FR4 Thickness=0.8(mm)
Specific dielectric constant=4.4

MGF0915A RF TEST DATA(CW) VD=10V, IDQ=0.8A
 Gp, Po, Id(RF), Ig(RF) v.s. Pin

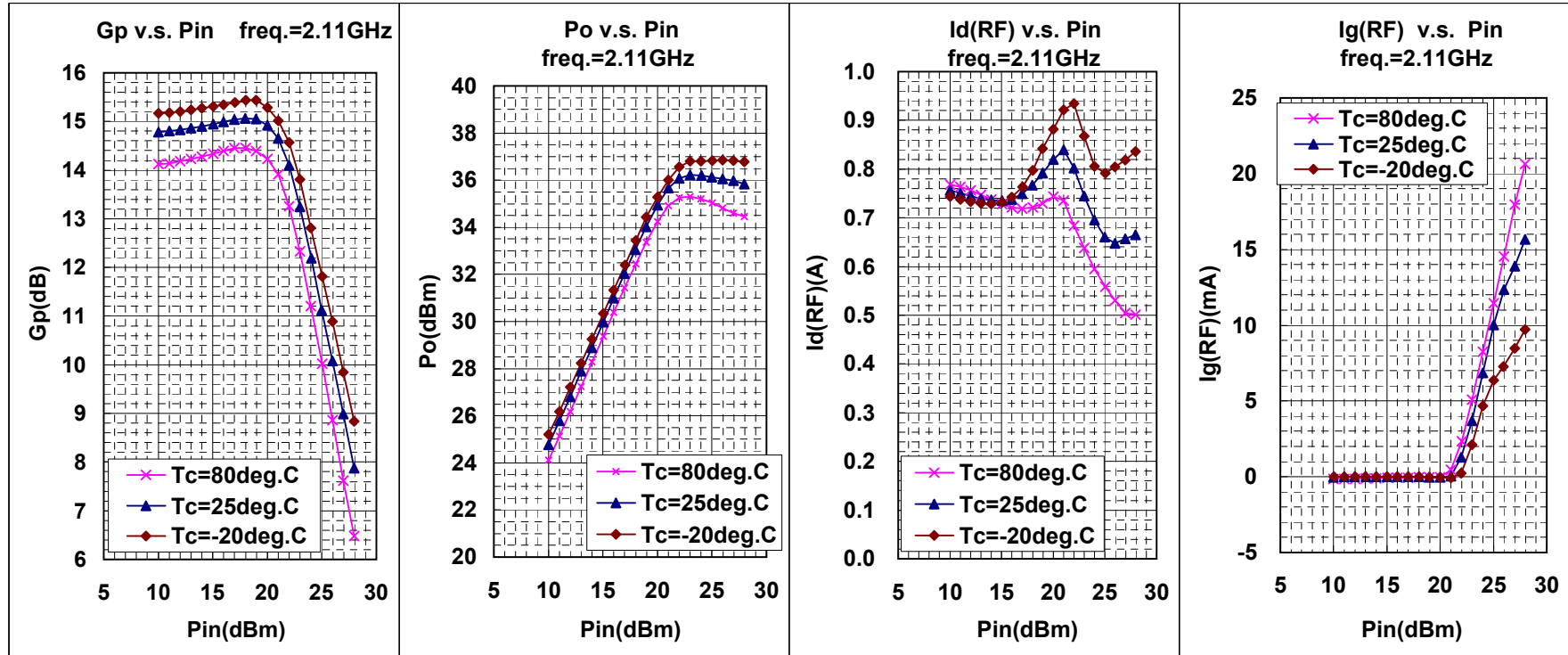

MGF0915A RF TEST DATA(CW) VD=10V, IDQ=0.8A
 Gp, Po, Id(RF), Ig(RF) v.s. Pin

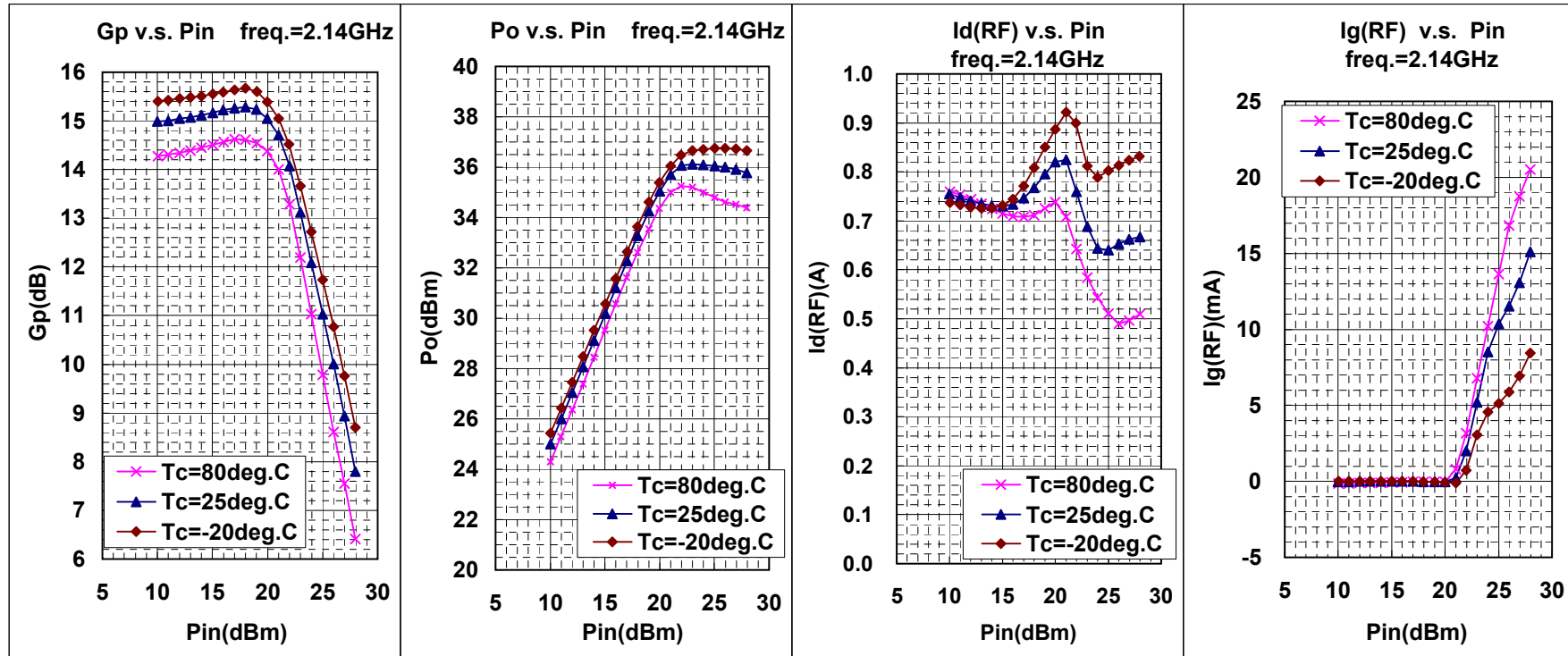

MGF0915A RF TEST DATA(CW) VD=10V, IDQ=0.8A
Gp, Po, Id(RF), Ig(RF) v.s. Pin

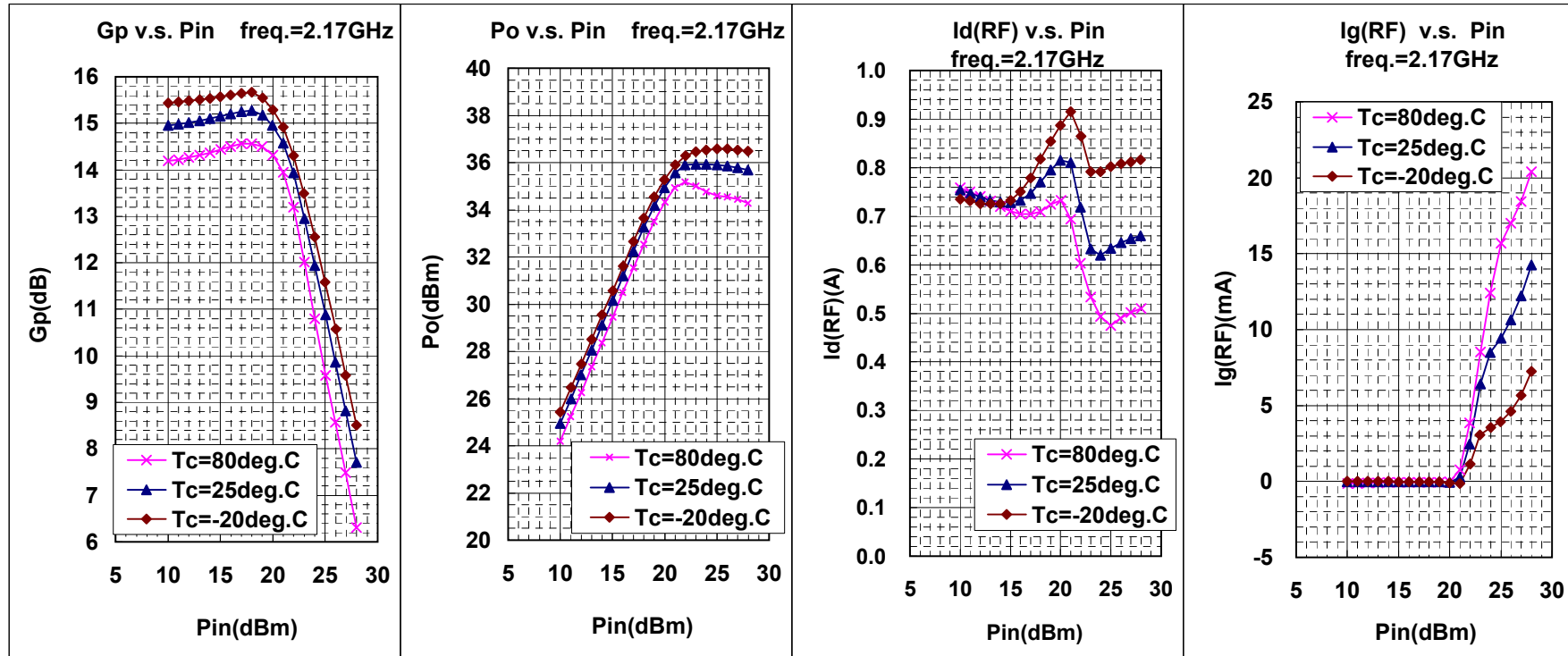

MGF0915A RF TEST DATA(CW)
Gp,Po,Id(RF),Ig(RF) v.s. Pin

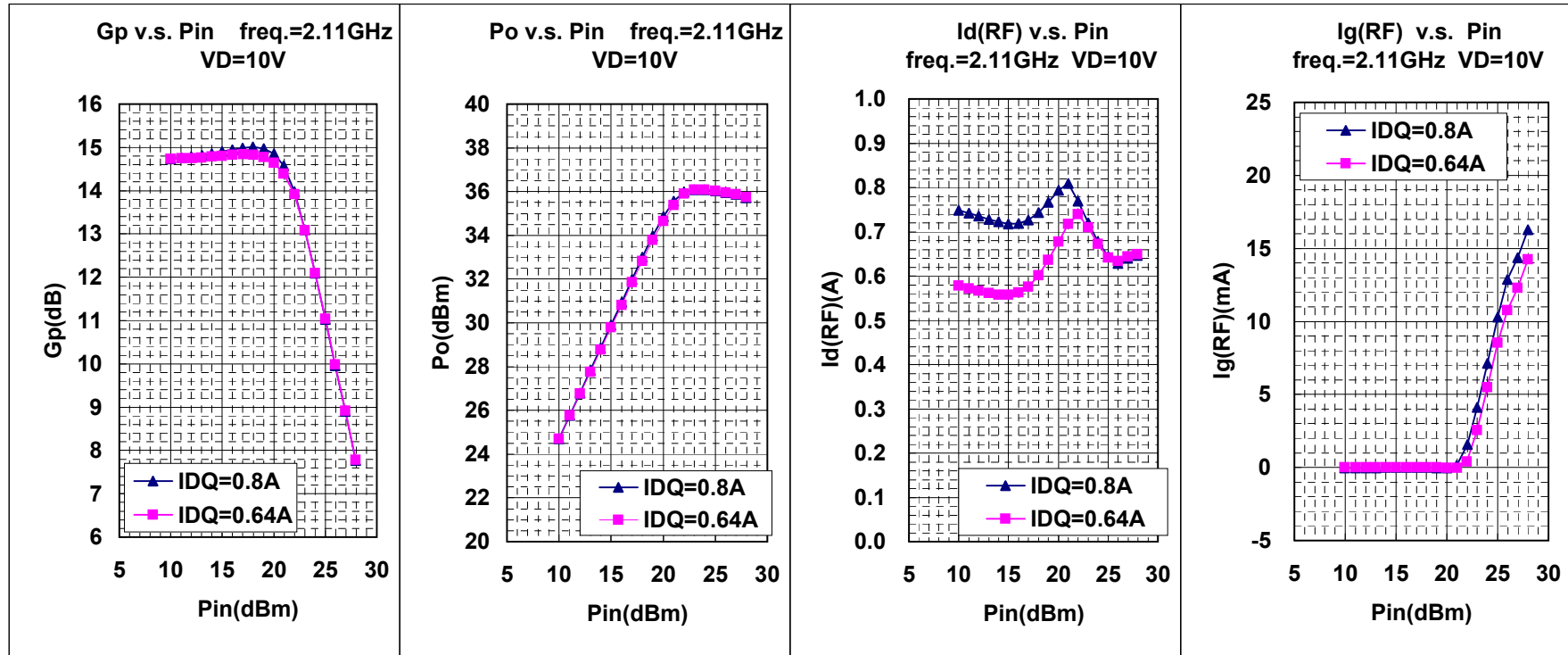

MGF0915A RF TEST DATA(CW)
Gp,Po,Id(RF),Ig(RF) v.s. Pin

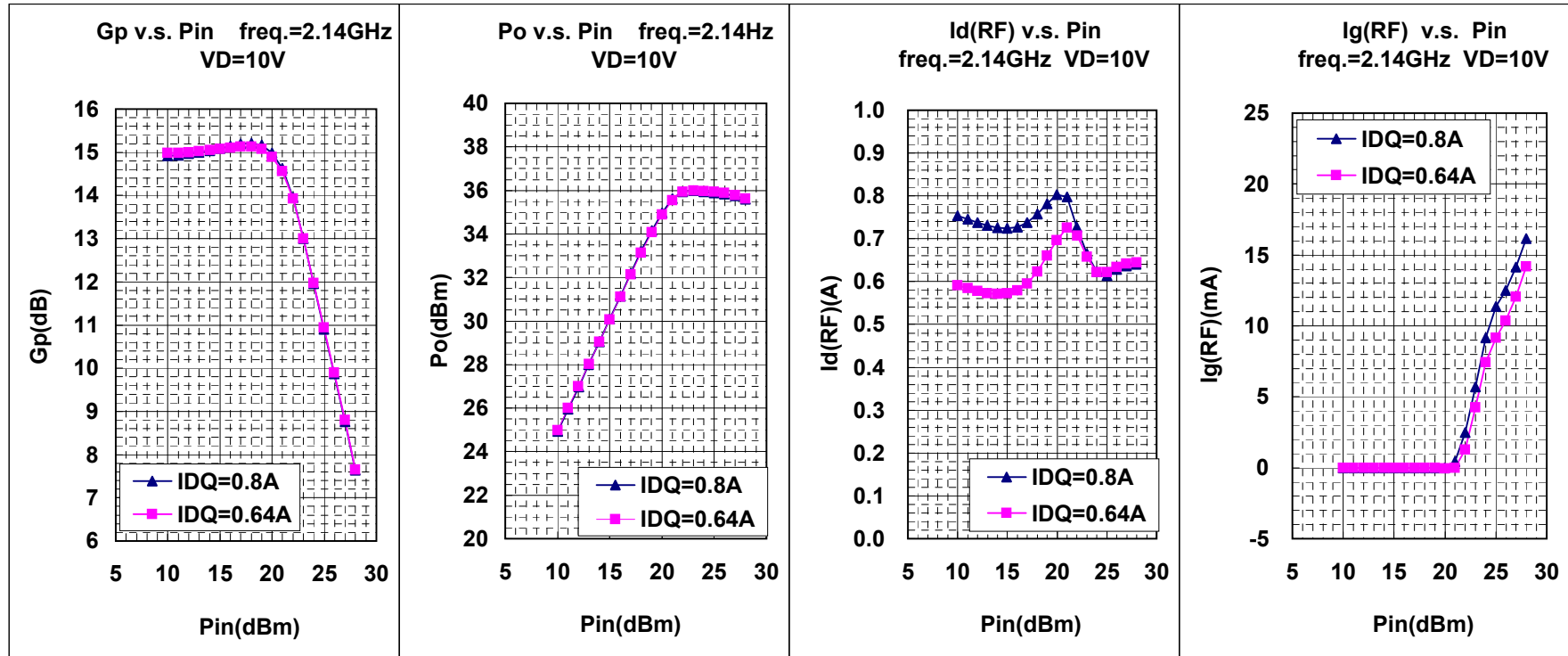

MGF0915A RF TEST DATA(CW)
Gp,Po,Id(RF),I_g(RF) v.s. Pin

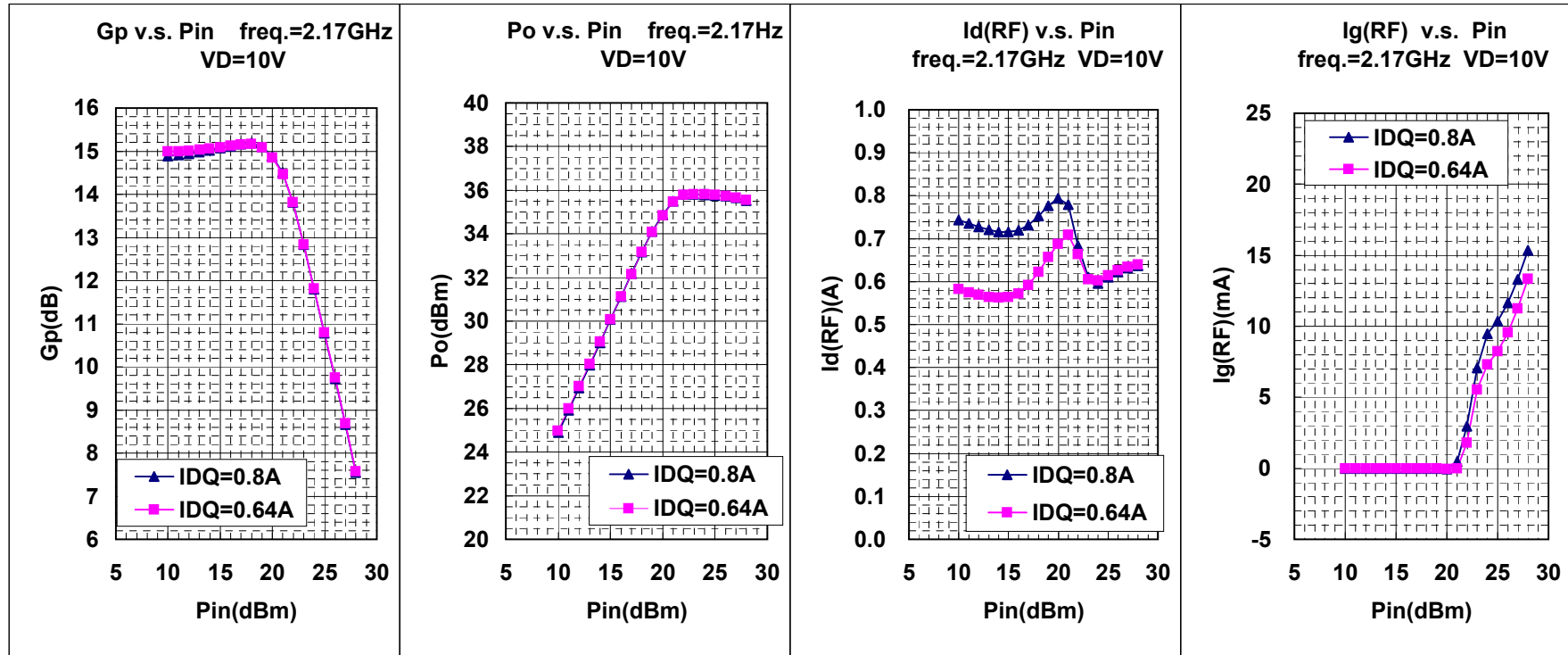

MGF0915A RF TEST DATA(CW)
Gp,Po,Id(RF),I_g(RF) v.s. Pin

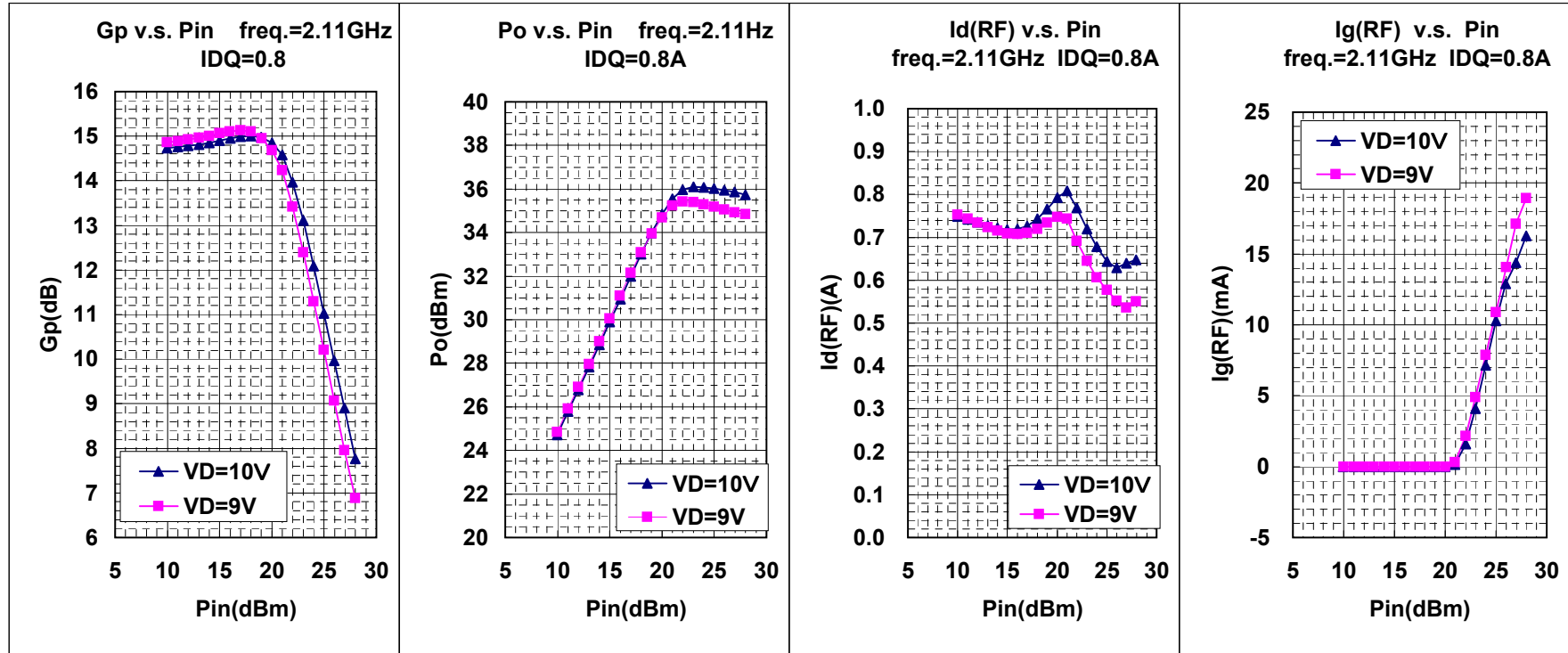

MGF0915A RF TEST DATA(CW)
Gp,Po,Id(RF),I_g(RF) v.s. Pin

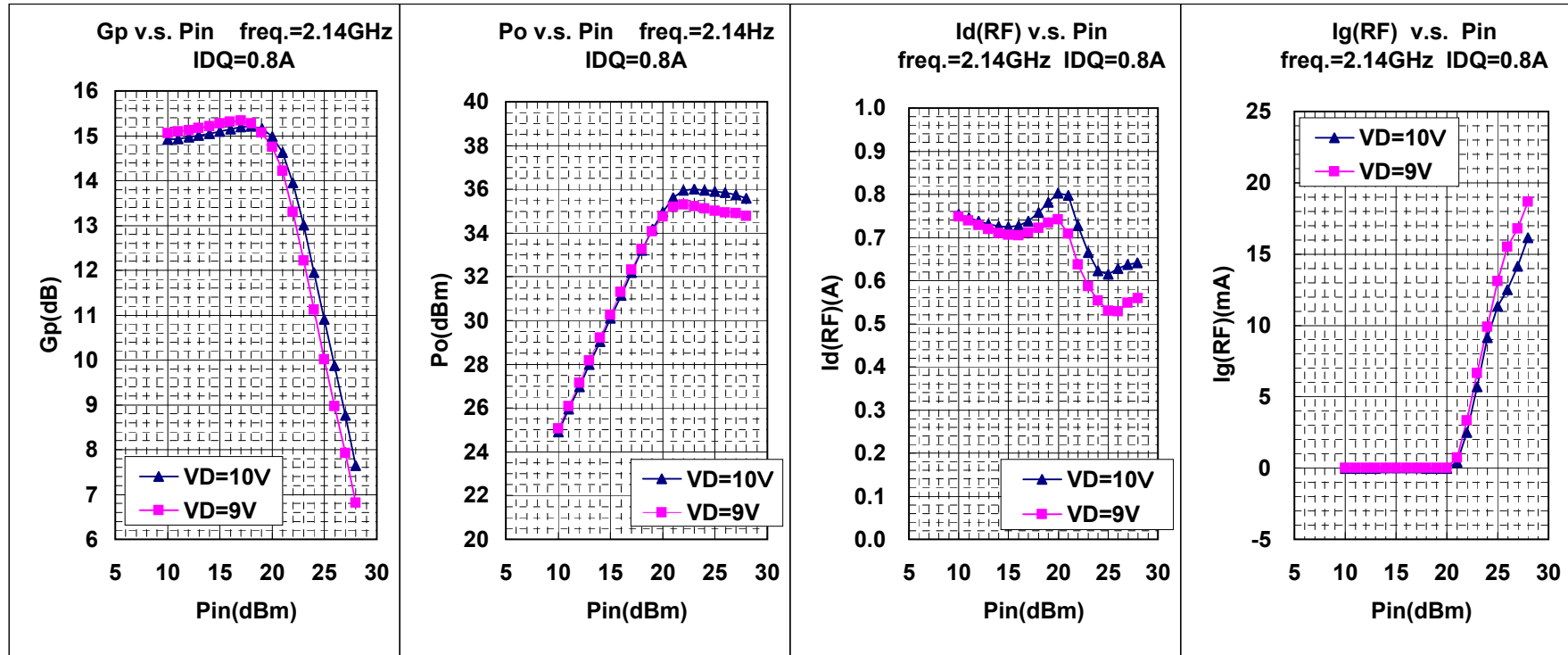

MGF0915A RF TEST DATA(CW)
Gp,Po,Id(RF),I_g(RF) v.s. Pin

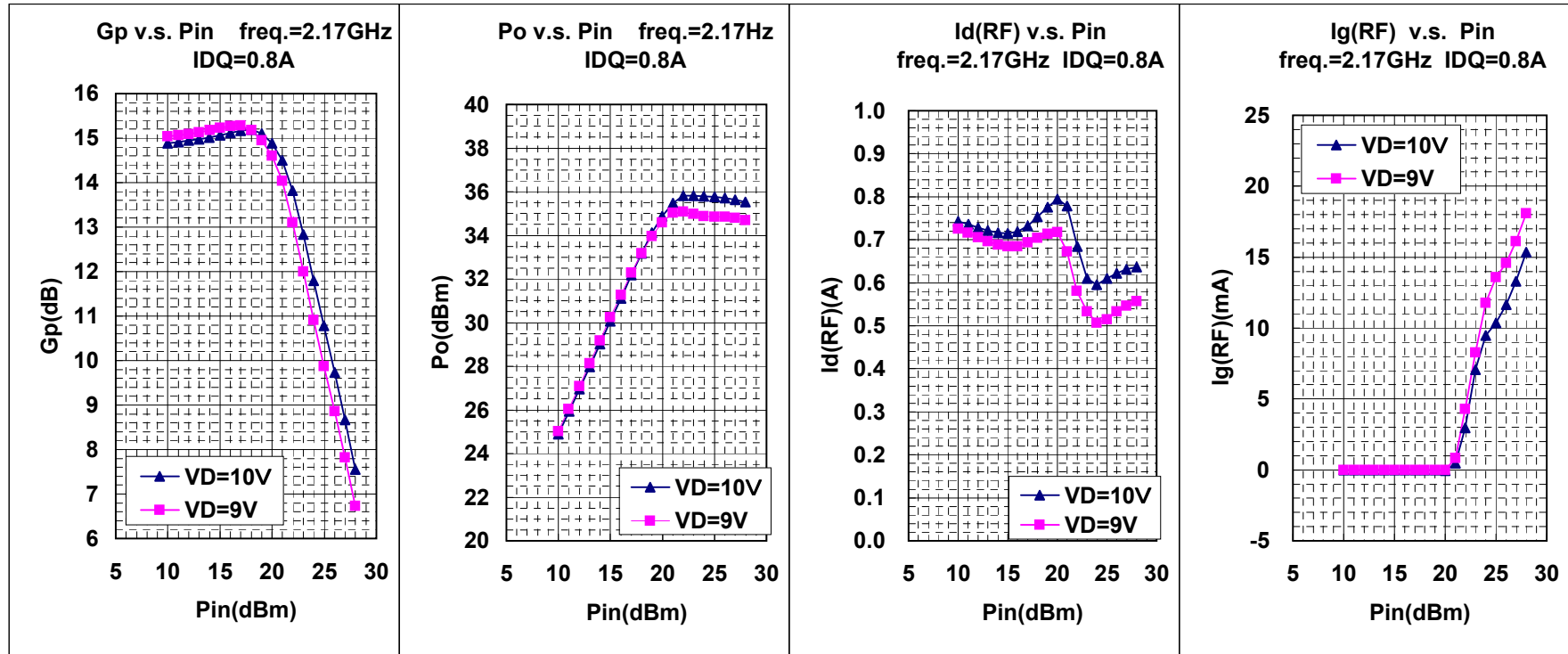

MGF0915A RF TEST DATA(W-CDMA) VD=10V, IDQ=0.8A
ACLR v.s. Po 3GPP TEST MODEL1 64ch's 2carrier Signal

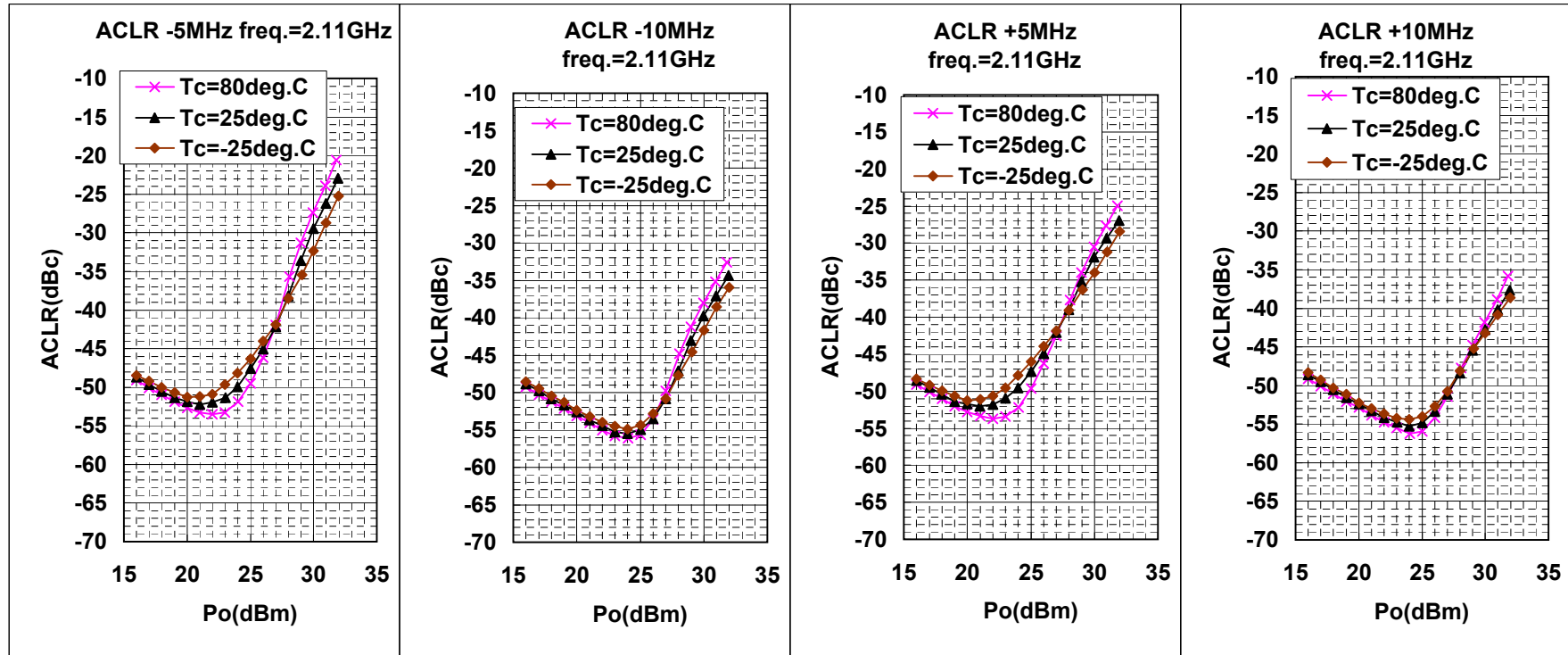

MGF0915A RF TEST DATA(W-CDMA) VD=10V, IDQ=0.8A
ACLR v.s. Po 3GPP TEST MODEL1 64ch's 2carrier Signal

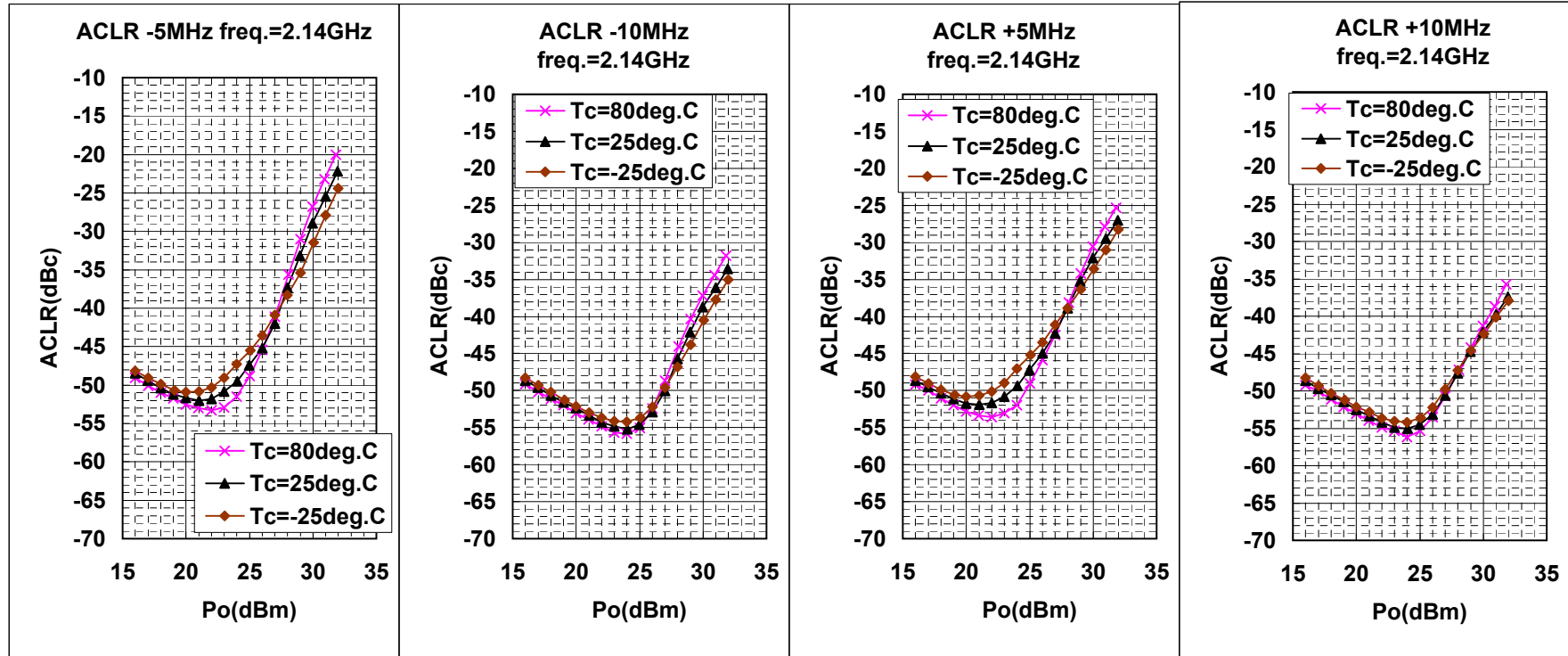

MGF0915A RF TEST DATA(W-CDMA) VD=10V, IDQ=0.8A
 ACLR v.s. Po 3GPP TEST MODEL1 64ch's 2carrier Signal

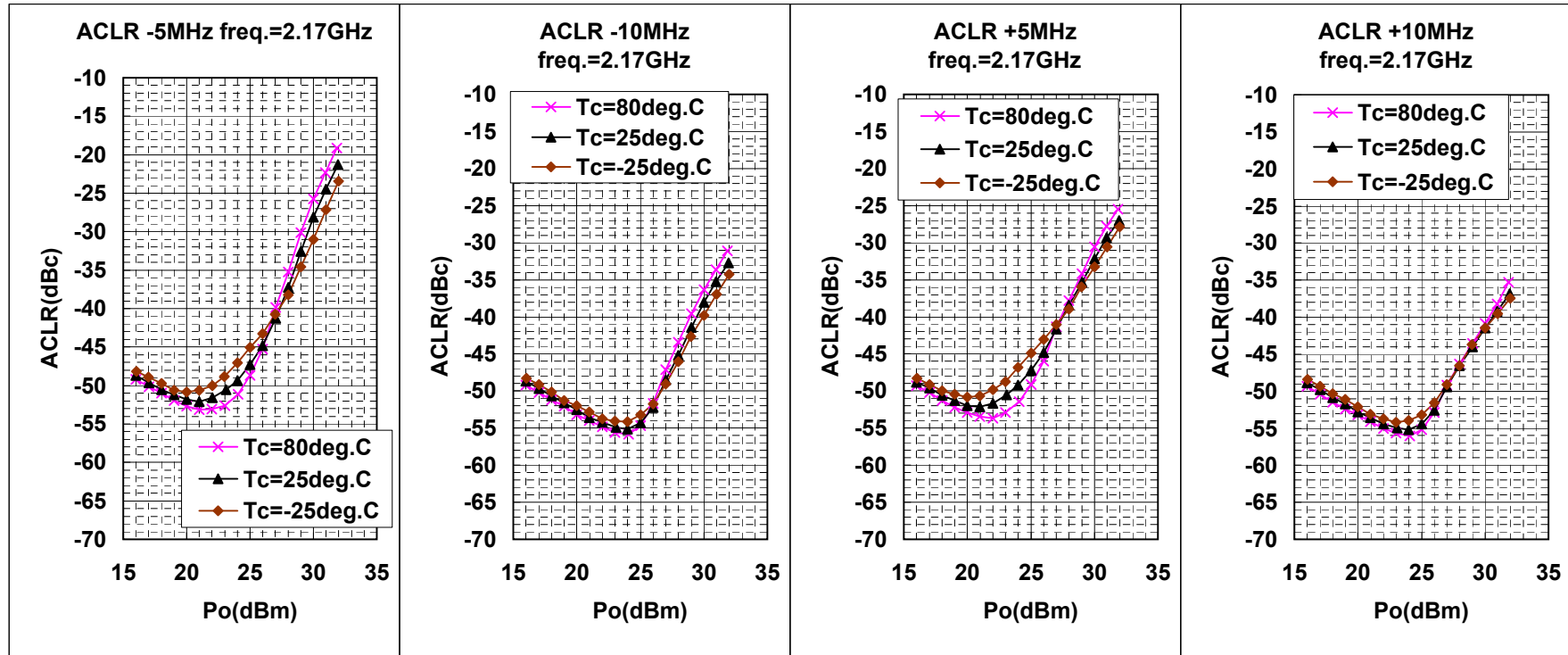

MGF0915A RF TEST DATA(W-CDMA)
ACLR v.s. Po 3GPP TEST MODEL1 64ch's 2carrier Signal

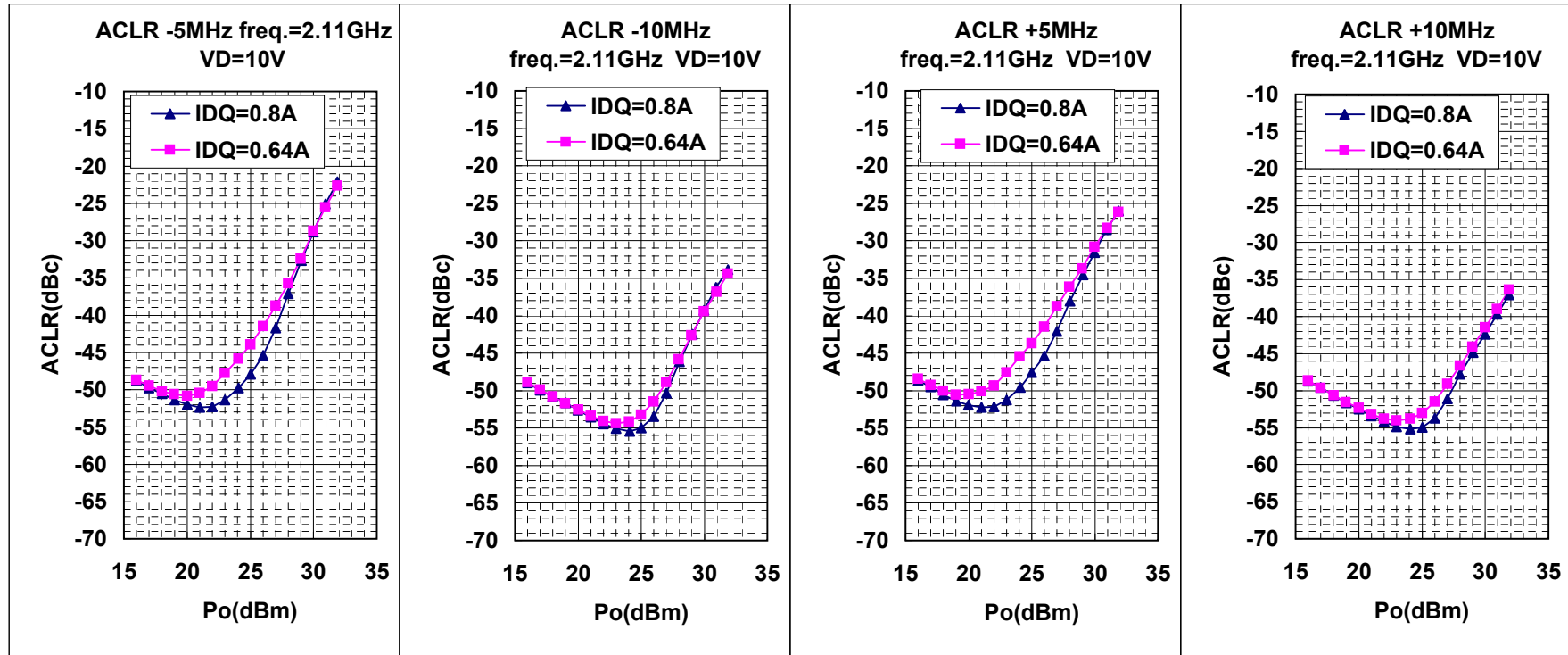

MGF0915A RF TEST DATA(W-CDMA)
ACLR v.s. Po 3GPP TEST MODEL1 64ch's 2carrier Signal

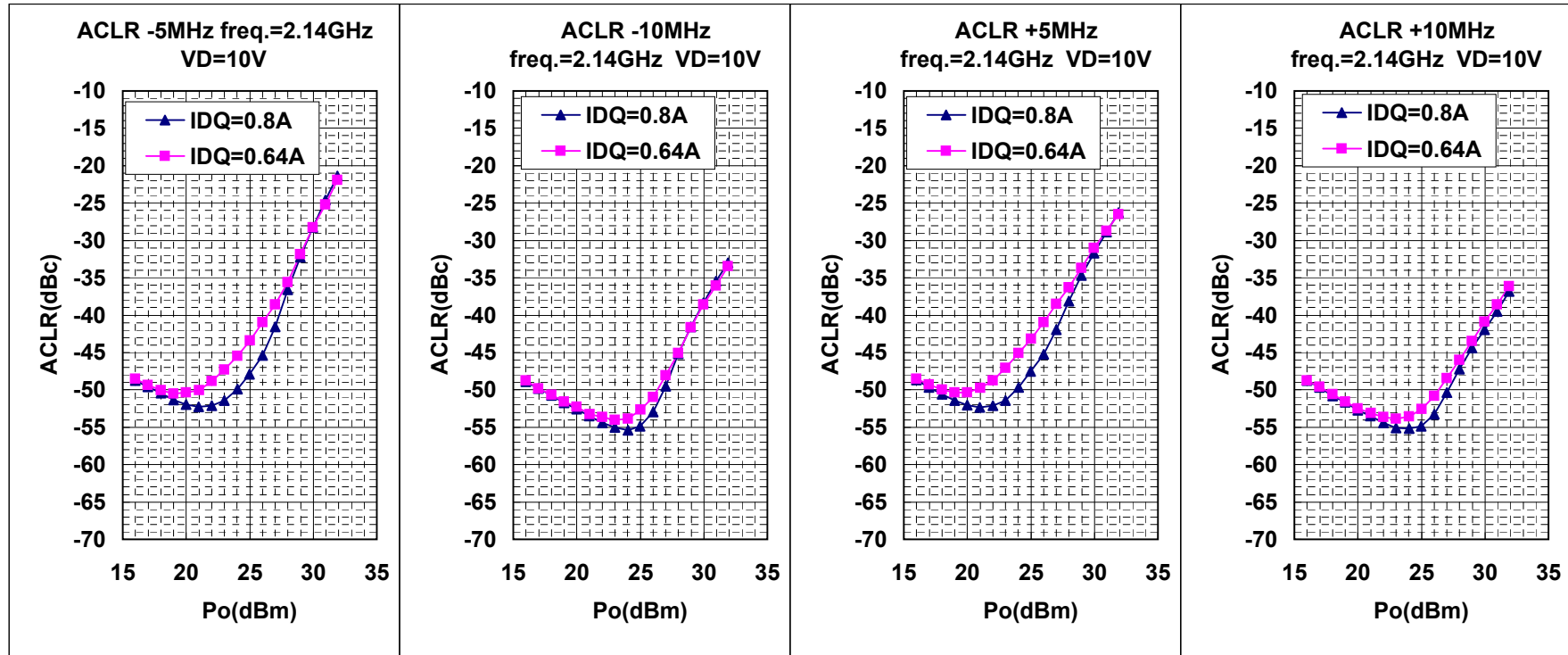

MGF0915A RF TEST DATA(W-CDMA)
ACLR v.s. Po 3GPP TEST MODEL1 64ch's 2carrier Signal

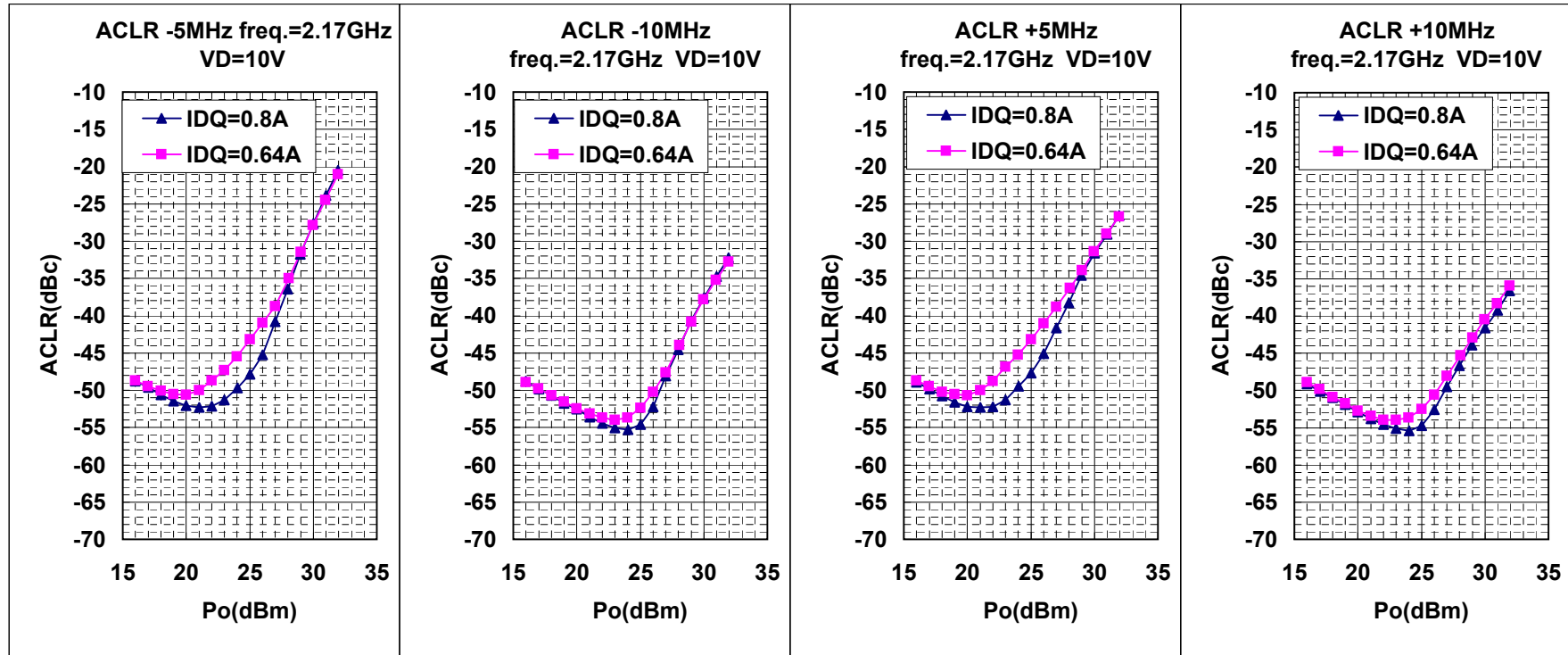

MGF0915A RF TEST DATA(W-CDMA)
ACLR v.s. Po 3GPP TEST MODEL1 64ch's 2carrier Signal

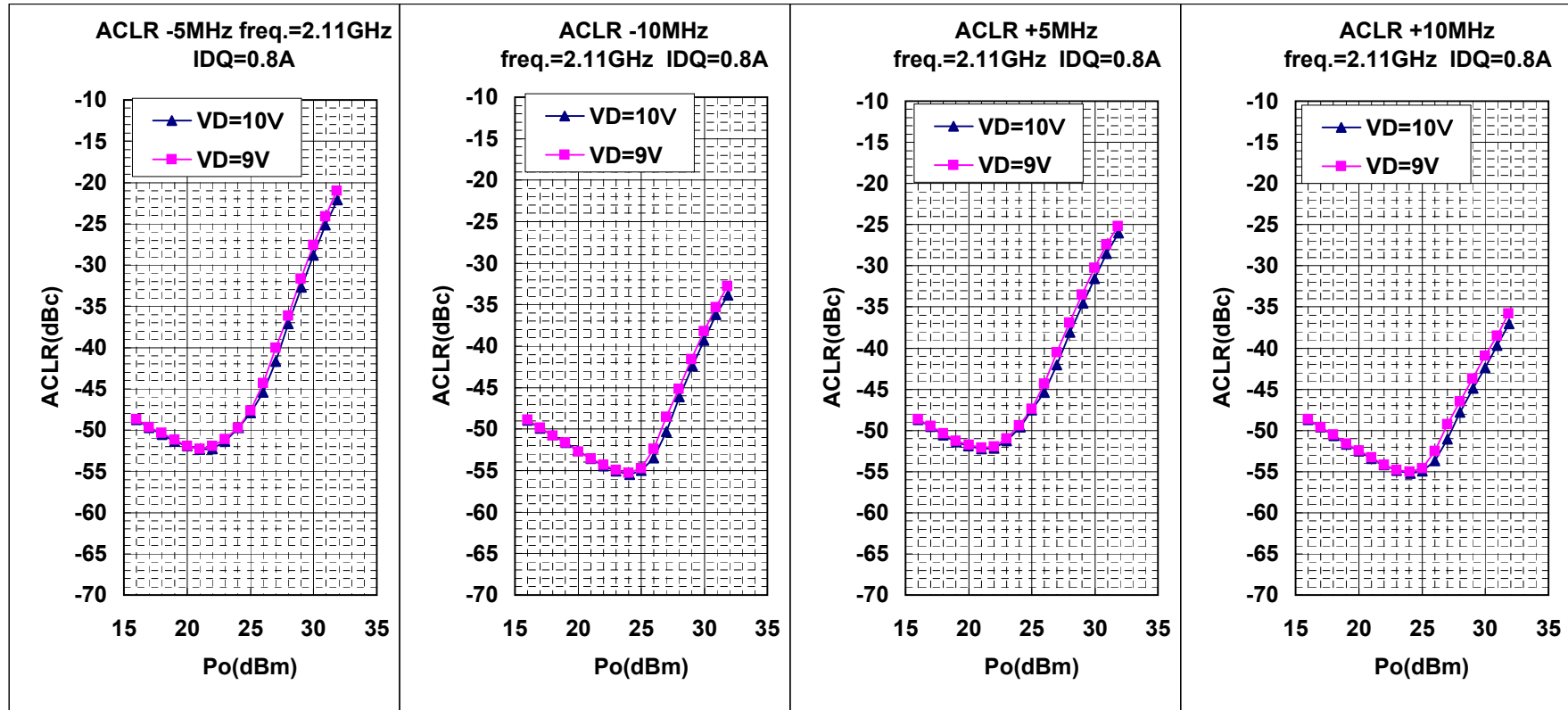

MGF0915A RF TEST DATA(W-CDMA)
ACLR v.s. Po 3GPP TEST MODEL1 64ch's 2carrier Signal

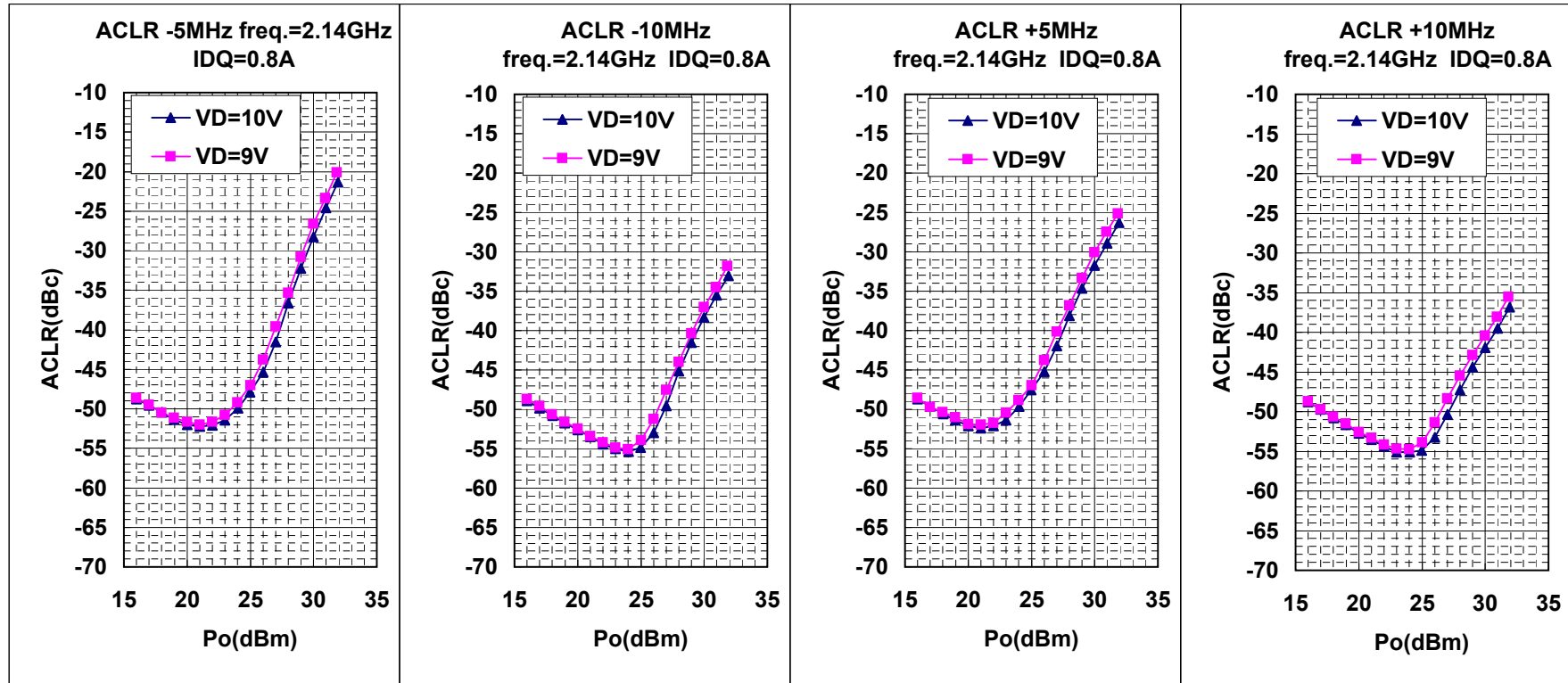

MGF0915A RF TEST DATA(W-CDMA)
ACLR v.s. Po 3GPP TEST MODEL1 64ch's 2carrier Signal

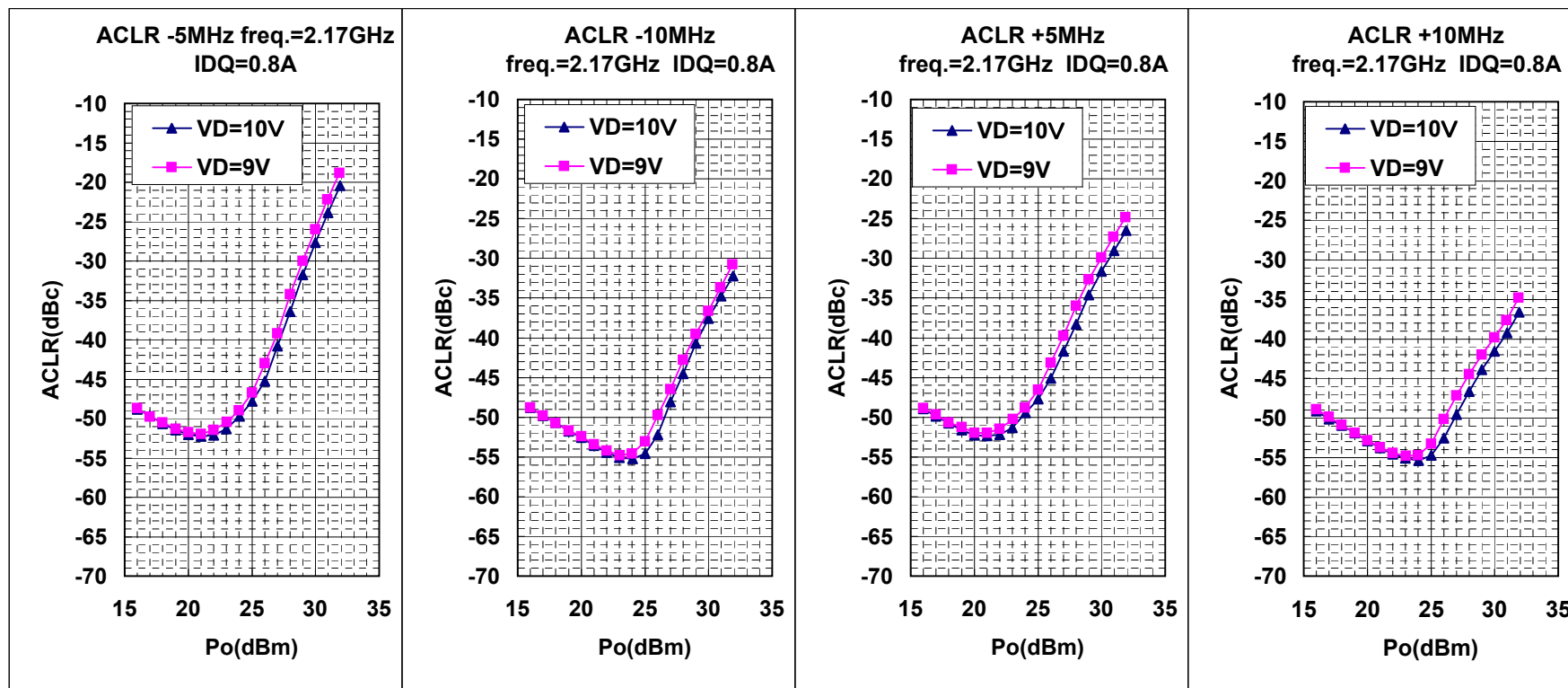

MGF0915A RF TEST DATA VD=10V, IDQ=0.8A
IM3, IM5 v.s. Pin

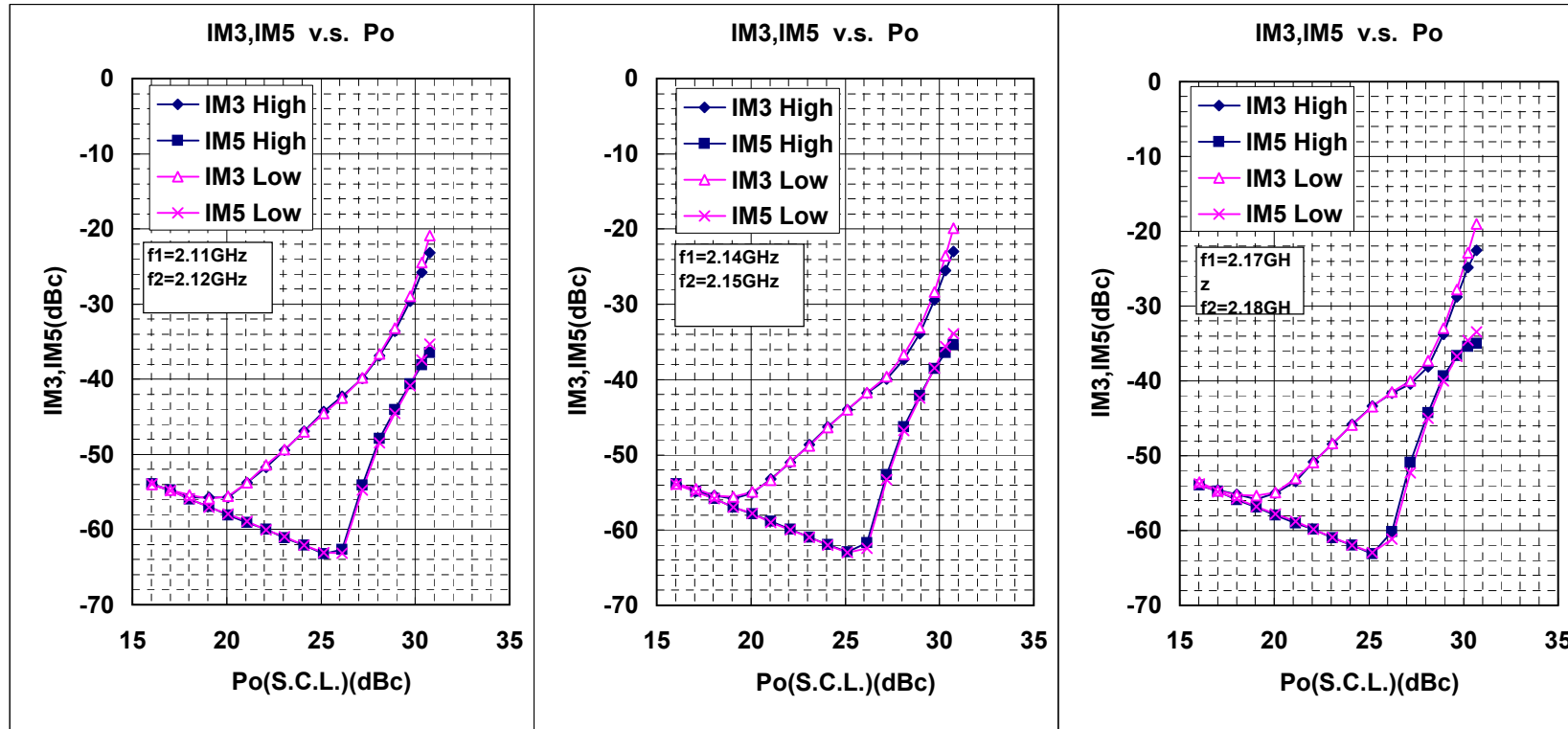

MGF0951P TEST FIXTURE $f=2.11-2.17\text{GHz}$

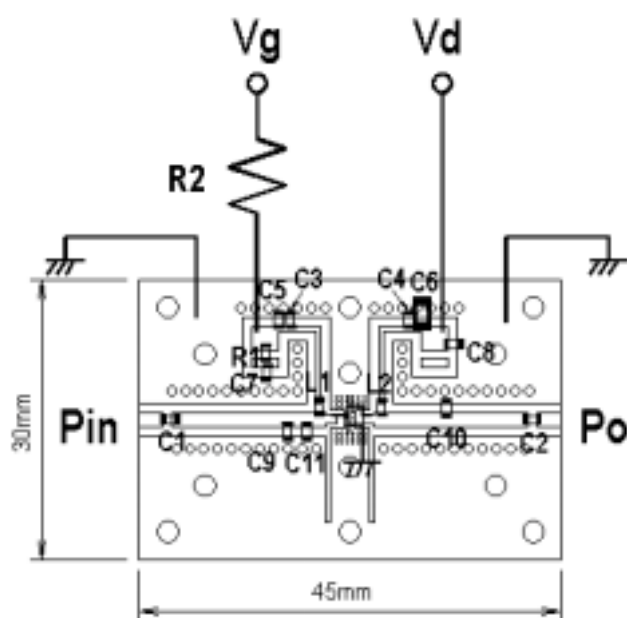

- C1,C2,C3,C4=20pF
- C5,C7,C8=1000pF
- C9=2pF
- C10=1pF
- C11=0.5pF
- C6=4.7uF
- L1,L2=12nH
- R1=51ohm
- R2=500ohm

Board material:FR4 Thickness=0.8(mm)
Specific dielectric constant=4.4

L & S BAND GaAs FET [SMD non - matched]**Requests Regarding Safety Designs**

Mitsubishi Electric constantly strives to raise the level of its quality and reliability. Despite these concerted efforts, however, there will be occasions when our semiconductor products suffer breakdowns, malfunctions or other problems. In view of this reality, it is requested that every feasible precaution be taken in the pursuit of redundancy design, malfunction prevention design and other safety-related designs, to prevent breakdowns or malfunctions in our products from resulting in accidents involving people, fires, social losses or other problems, thereby upholding the highest levels of safety in the products when in use by customers.

Matters of Importance when Using these Materials

1. These materials are designed as reference materials to ensure that all customers purchase Mitsubishi Electric semiconductors best suited to their specific use applications. Please be aware, however, that the technical information contained in these materials does not comprise consent for the execution or use of intellectual property rights or other rights owned by Mitsubishi Electric Corporation.
2. Mitsubishi Electric does not assume responsibility for damages resulting from the use of product data, graphs, charts, programs, algorithms or other applied circuit examples described in these materials, or for the infringement of the rights of third-party owners resulting from such use.
3. The data, graphs, charts, programs, algorithms and all other information described in these materials were current at the issue of these materials, with Mitsubishi Electric reserving the right to make any necessary updates or changes in the products or specifications in these materials without prior notice. Before purchasing Mitsubishi Electric semiconductor products, therefore, please obtain the latest available information from Mitsubishi Electric directly or an authorized dealer.
4. Every possible effort has been made to ensure that the information described in these materials is fully accurate. However, Mitsubishi Electric assumes no responsibility for damages resulting from inaccuracies occurring within these materials.
5. When using the product data, technical contents indicated on the graphs, charts, programs or algorithms described in these materials, assessments should not be limited to only the technical contents, programs and algorithm units. Rather, it is requested that ample evaluations be made of each individual system as a whole, with the customer assuming full responsibility for decisions on the propriety of application. Mitsubishi Electric does not accept responsibility for the propriety of application.
6. The products described in these materials, with the exception of special mention concerning use and reliability, have been designed and manufactured with the purpose of use in general electronic machinery. Accordingly these products have not been designed and manufactured with the purpose of application in machinery or systems that will be used under conditions that can affect human life, or in machinery or systems used in social infrastructure that demand a particularly high degree of reliability. When considering the use of the products described in these materials in transportation machinery (automobiles, trains, vessels), for objectives related to medical treatment, aerospace, nuclear power control, submarine repeaters or systems or other specialized applications, please consult with Mitsubishi Electric directly or an authorized dealer.
7. When considering use of products for purposes other than the specific applications described in these materials, please inquire at Mitsubishi Electric or an authorized dealer.
8. The prior consent of Mitsubishi Electric in writing is required for any reprinting or reproduction of these materials.
9. Please direct any inquiries regarding further details of these materials, or any other comments or matters of attention, to Mitsubishi Electric or an authorized dealer.