

V_{CE} = 650 V, I_C = 60 A
Trench Field Stop IGBTs with Fast Recovery Diode
KGF65A6H, MGF65A6H

Description

The KGF65A6H and MGF65A6H are 650 V Field Stop IGBTs. Sanken original trench structure decreases gate capacitance, and achieves high speed switching and switching loss reduction. Thus, these Field Stop IGBTs can improve the efficiency of your circuit.

Features

- Low Saturation Voltage
- High Speed Switching
- With Integrated Fast Recovery Diode
- RoHS Compliant

- V_{CE} ----- 650 V
- I_C (T_C = 100 °C) ----- 60 A
- Short Circuit Withstand Time ----- 10 μs
- V_{CE(sat)} ----- 1.9 V typ.
- t_f (T_J = 175 °C) ----- 60 ns typ.
- V_F ----- 1.8 V typ.

Applications

- Welding Invertor
- PFC Circuit

Packages

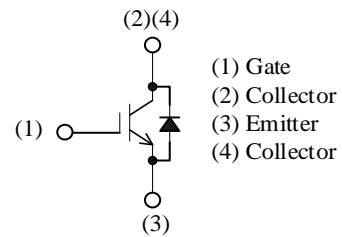
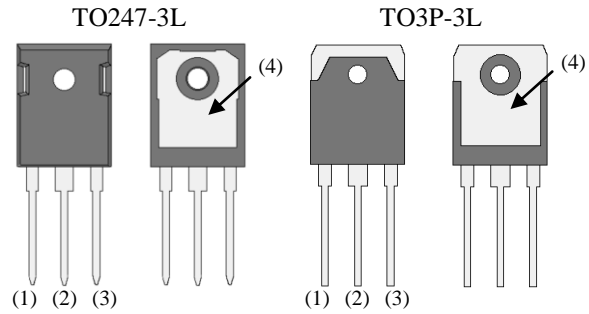

Not to scale

Selection Guide

Part Number	Package
KGF65A6H	TO247-3L
MGF65A6H	TO3P-3L

KGF65A6H, MGF65A6H

Absolute Maximum Ratings

Unless otherwise specified, $T_A = 25\text{ }^\circ\text{C}$.

Parameter	Symbol	Conditions	Rating	Unit	Remarks
Collector to Emitter Voltage	V_{CE}		650	V	
Gate to Emitter Voltage	V_{GE}		± 30	V	
Continuous Collector Current ⁽¹⁾	I_C	$T_C = 25\text{ }^\circ\text{C}$	80 ⁽²⁾	A	
		$T_C = 100\text{ }^\circ\text{C}$	60	A	
Pulsed Collector Current	$I_{C(PULSE)}$	$PW \leq 1\text{ ms}$, duty cycle $\leq 1\%$	180	A	
Diode Continuous Forward Current ⁽¹⁾	I_F	$T_C = 25\text{ }^\circ\text{C}$	40 ⁽²⁾	A	
		$T_C = 100\text{ }^\circ\text{C}$	30	A	
Diode Pulsed Forward Current	$I_{F(PULSE)}$	$PW \leq 1\text{ ms}$, duty cycle $\leq 1\%$	100	A	
Short Circuit Withstand Time	t_{SC}	$V_{GE} = 15\text{ V}$, $V_{CE} = 400\text{ V}$, $T_J = 175\text{ }^\circ\text{C}$	10	μs	
Power Dissipation	P_D	$T_C = 25\text{ }^\circ\text{C}$	405	W	
Operating Junction Temperature	T_J		175	$^\circ\text{C}$	
Storage Temperature	T_{STG}		-55 to 150	$^\circ\text{C}$	

Thermal Characteristics

Unless otherwise specified, $T_A = 25\text{ }^\circ\text{C}$.

Parameter	Symbol	Conditions	Min.	Typ.	Max.	Unit	Remarks
Thermal Resistance of IGBT (Junction to Case)	$R_{\theta JC}$ (IGBT)		—	—	0.38	$^\circ\text{C/W}$	
Thermal Resistance of Diode (Junction to Case)	$R_{\theta JC}$ (Di)		—	—	1.15	$^\circ\text{C/W}$	

⁽¹⁾ I_C and I_F are determined by the maximum junction temperature for TO3P-3L package.

⁽²⁾ Determined by bonding wires capability.

KGF65A6H, MGF65A6H

Electrical Characteristics

Unless otherwise specified, $T_A = 25\text{ }^\circ\text{C}$.

Parameter	Symbol	Conditions	Min.	Typ.	Max.	Unit	
Collector to Emitter Breakdown Voltage	$V_{(BR)CES}$	$I_C = 100\ \mu\text{A}$, $V_{GE} = 0\ \text{V}$	650	—	—	V	
Collector to Emitter Leakage Current	I_{CES}	$V_{CE} = 650\ \text{V}$, $V_{GE} = 0\ \text{V}$	—	—	100	μA	
Gate to Emitter Leakage Current	I_{GES}	$V_{GE} = \pm 30\ \text{V}$	—	—	± 500	nA	
Gate Threshold Voltage	$V_{GE(TH)}$	$V_{CE} = 10\ \text{V}$, $I_C = 1\ \text{mA}$	4.0	5.5	7.0	V	
Collector to Emitter Saturation Voltage	$V_{CE(sat)}$	$V_{GE} = 15\ \text{V}$, $I_C = 60\ \text{A}$	—	1.9	2.37	V	
Input Capacitance	C_{ies}	$V_{CE} = 20\ \text{V}$, $V_{GE} = 0\ \text{V}$, $f = 1.0\ \text{MHz}$	—	3500	—	pF	
Output Capacitance	C_{oes}		—	330	—		
Reverse Transfer Capacitance	C_{res}		—	170	—		
Gate Charge	Q_g	$V_{CE} = 520\ \text{V}$, $I_C = 60\ \text{A}$, $V_{GE} = 15\ \text{V}$	—	110	—	nC	
Turn-On Delay Time	$t_{d(on)}$	$T_J = 25\text{ }^\circ\text{C}$; see Figure 1	—	50	—	ns	
Rise Time	t_r		—	70	—		
Turn-Off Delay Time	$t_{d(off)}$		—	130	—		
Fall Time	t_f		—	40	—		
Turn-on Energy ⁽³⁾	E_{on}		—	1.4	—		mJ
Turn-off Energy	E_{off}	—	1.3	—			
Turn-On Delay Time	$t_{d(on)}$	$T_J = 175\text{ }^\circ\text{C}$; see Figure 1	—	50	—	ns	
Rise Time	t_r		—	70	—		
Turn-Off Delay Time	$t_{d(off)}$		—	160	—		
Fall Time	t_f		—	60	—		
Turn-on Energy ⁽³⁾	E_{on}		—	2.1	—		mJ
Turn-off Energy	E_{off}		—	1.8	—		
Emitter to Collector Diode Forward Voltage	V_F	$I_F = 30\ \text{A}$	—	1.8	—	V	
Emitter to Collector Diode Reverse Recovery Time	t_{rr}	$I_F = 30\ \text{A}$, $di/dt = 700\ \text{A}/\mu\text{s}$	—	50	—	ns	

⁽³⁾ Energy losses include the reverse recovery of diode.

Test Circuits and Waveforms

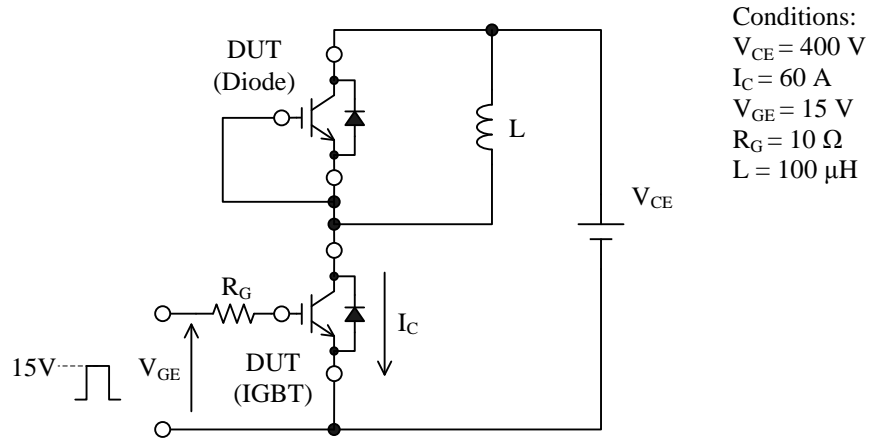

(a) Test Circuit

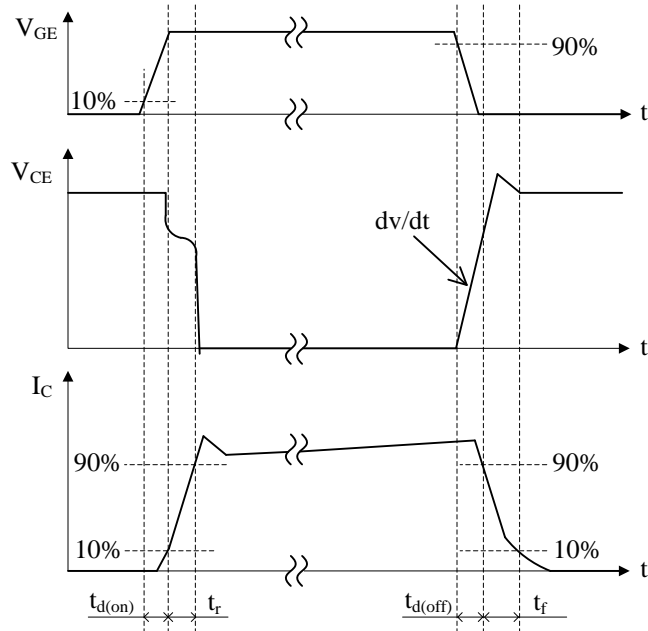

(b) Waveform

Figure 1. Test Circuits and Waveforms of dv/dt and Switching Time

Rating and Characteristic Curves

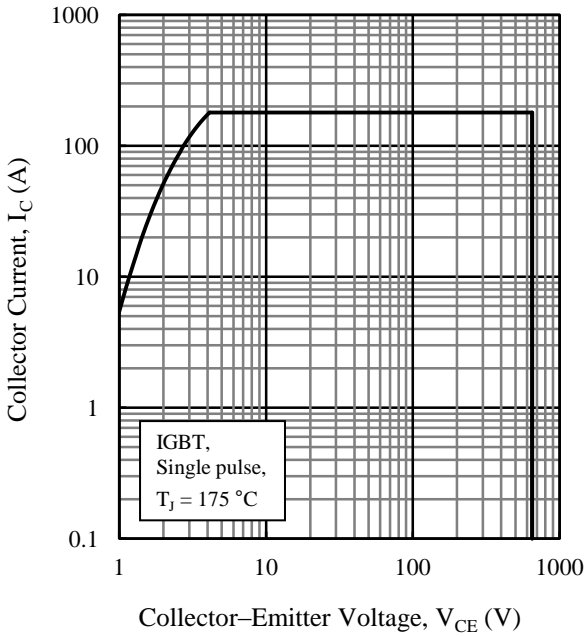

Figure 2. IGBT Reverse Bias Safe Operating Area

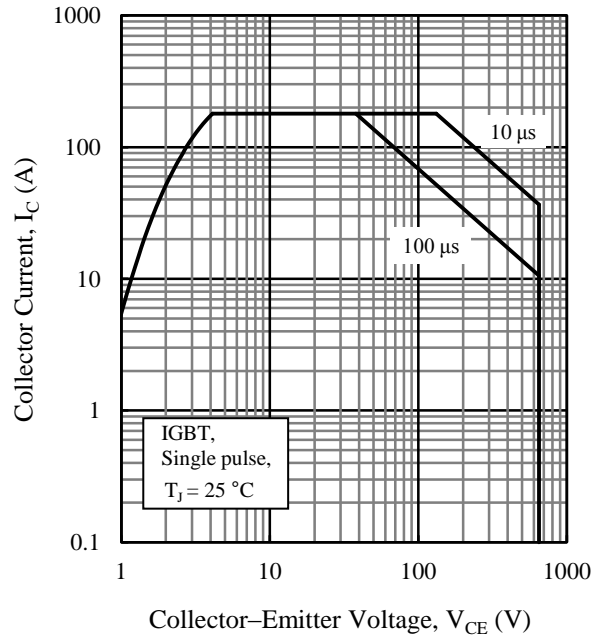

Figure 3. IGBT Safe Operating Area

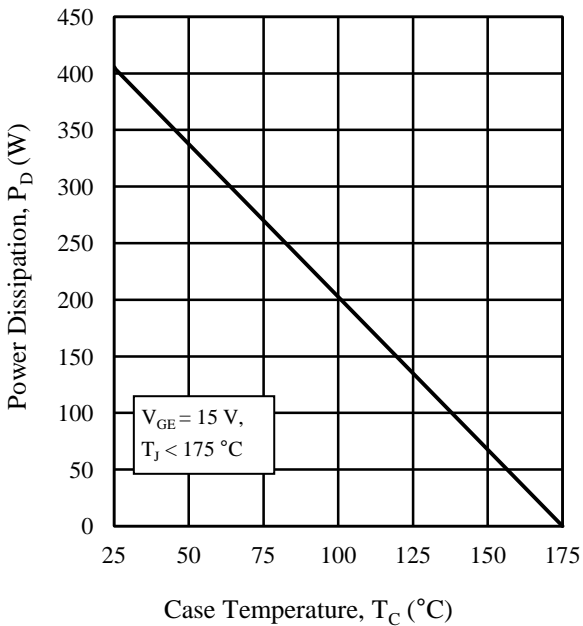

Figure 4. Power Dissipation vs. Case Temperature

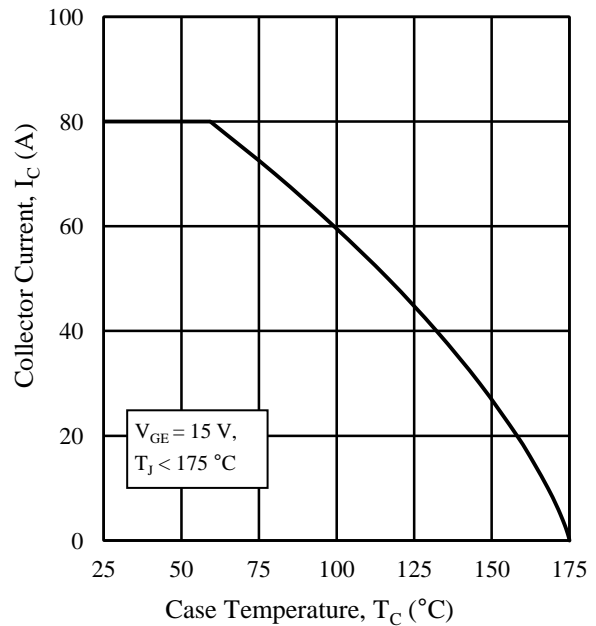

Figure 5. Collector Current vs. Case Temperature

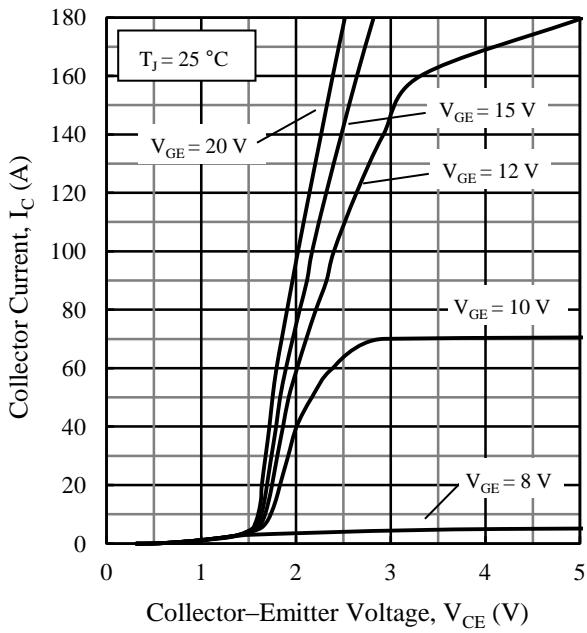

Figure 6. Output Characteristics ($T_J = 25\text{ }^\circ\text{C}$)

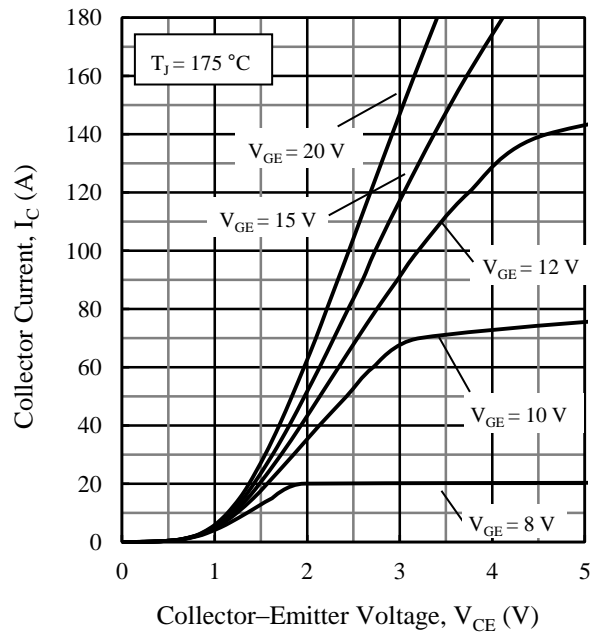

Figure 7. Output Characteristics ($T_J = 175\text{ }^\circ\text{C}$)

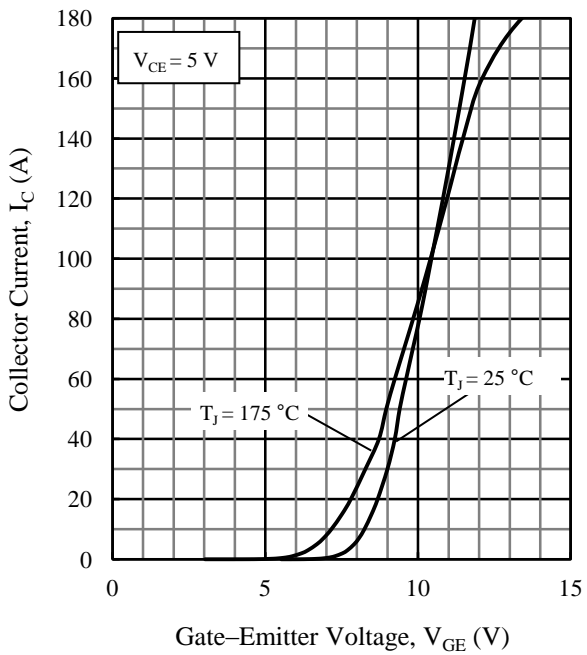

Figure 8. Transfer Characteristics

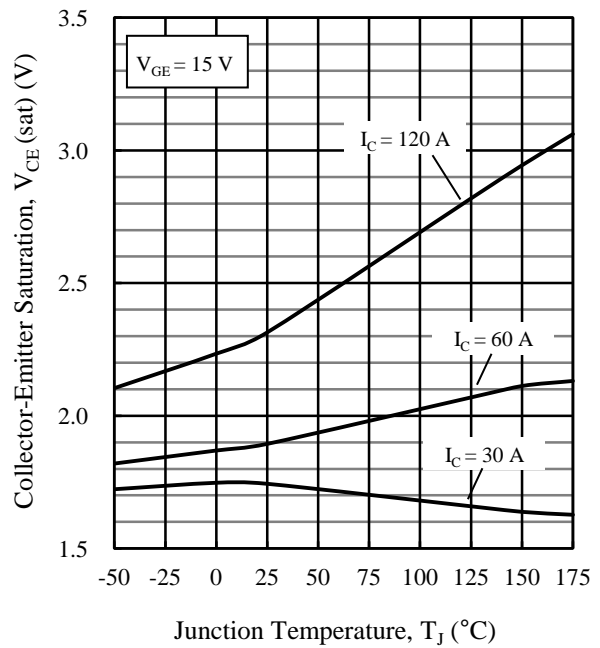

Figure 9. Saturation Voltage vs. Junction Temperature

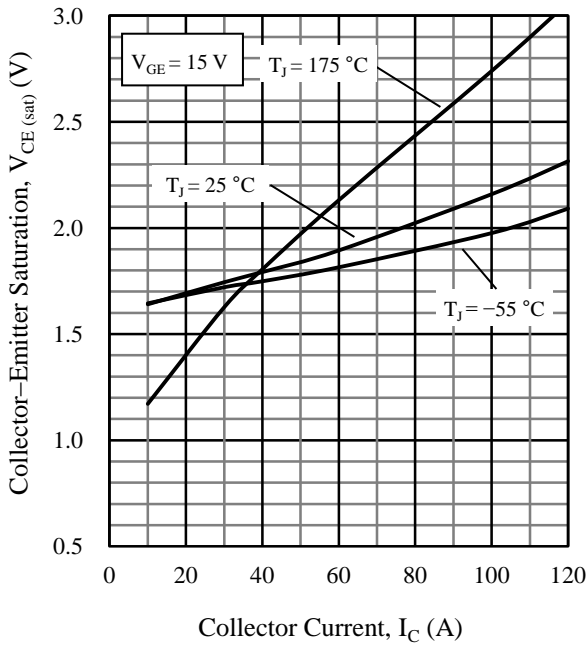

Figure 10. Saturation Voltage vs. Collector Current

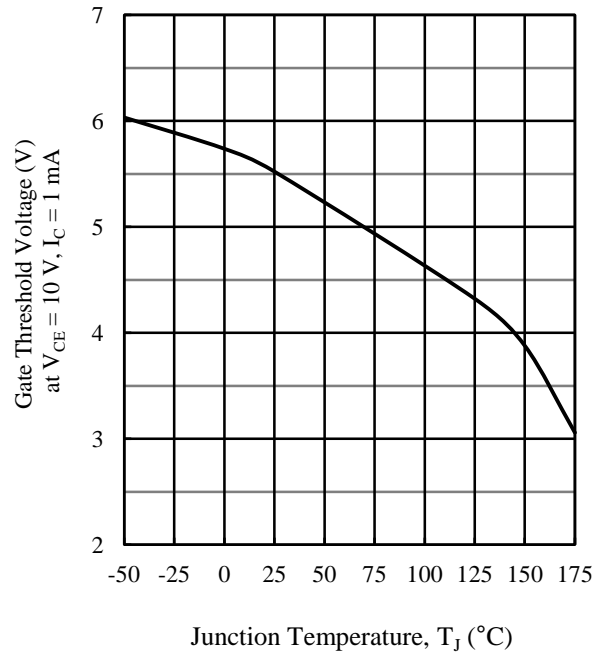

Figure 11. Gate Threshold Voltage vs. Junction Temperature

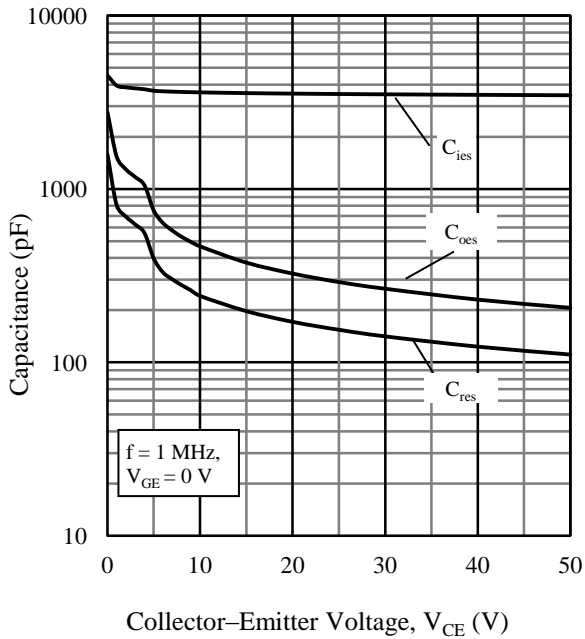

Figure 12. Capacitance Characteristics

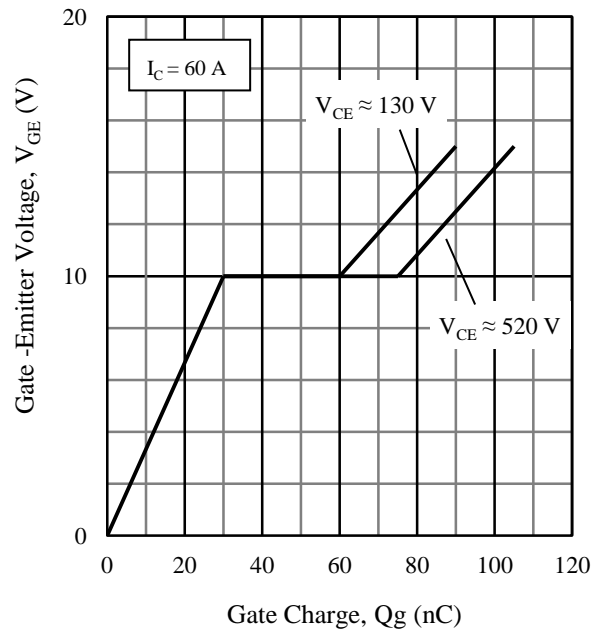

Figure 13. Typical Gate Charge

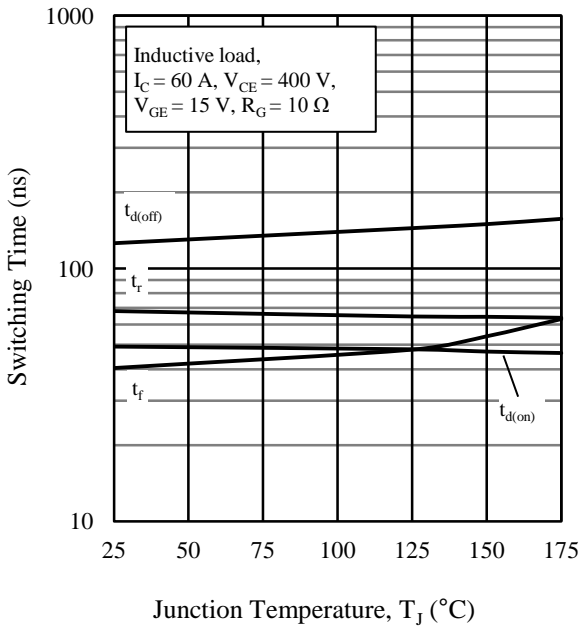

Figure 14. Switching Time vs. Junction Temperature

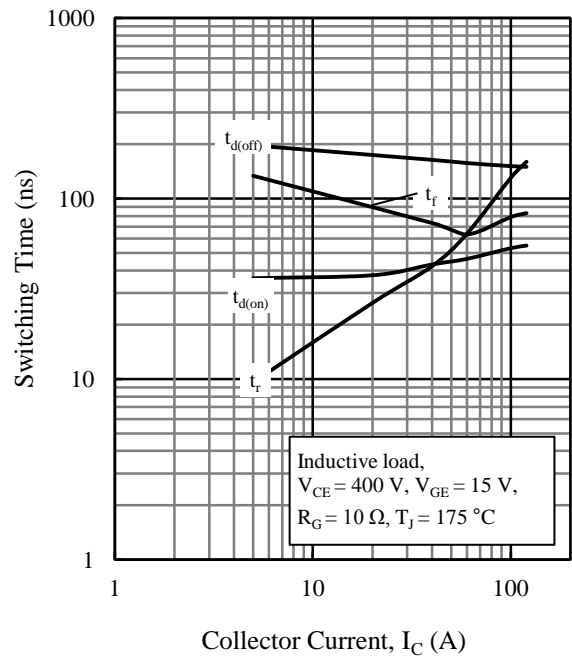

Figure 15. Switching Time vs. Collector Current

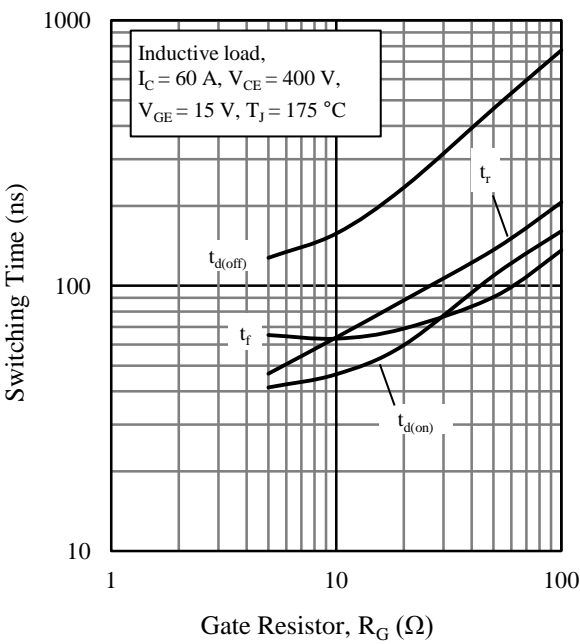

Figure 16. Switching Time vs. Gate Resistor

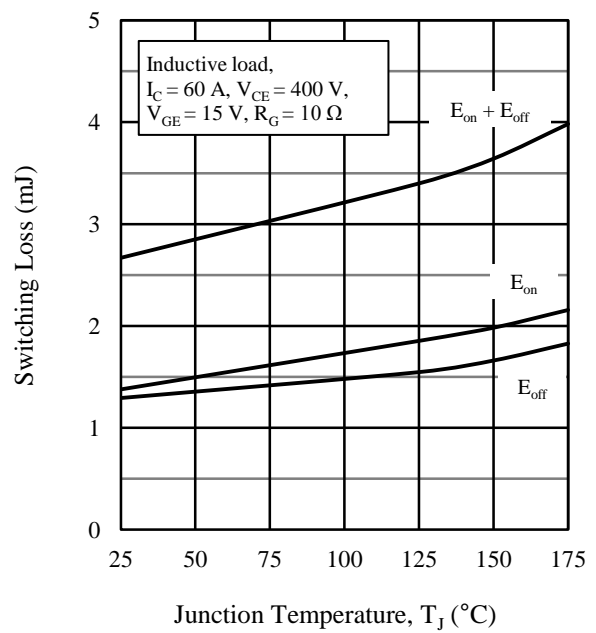

Figure 17. Switching Loss vs. Junction Temperature

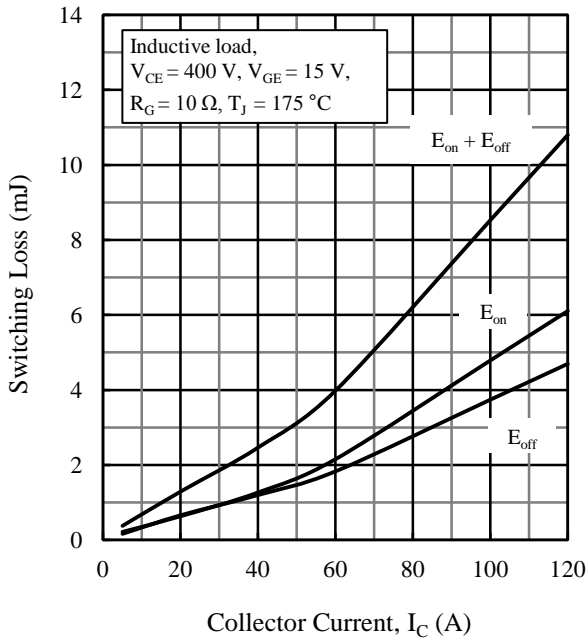

Figure 18. Switching Loss vs. Collector Current

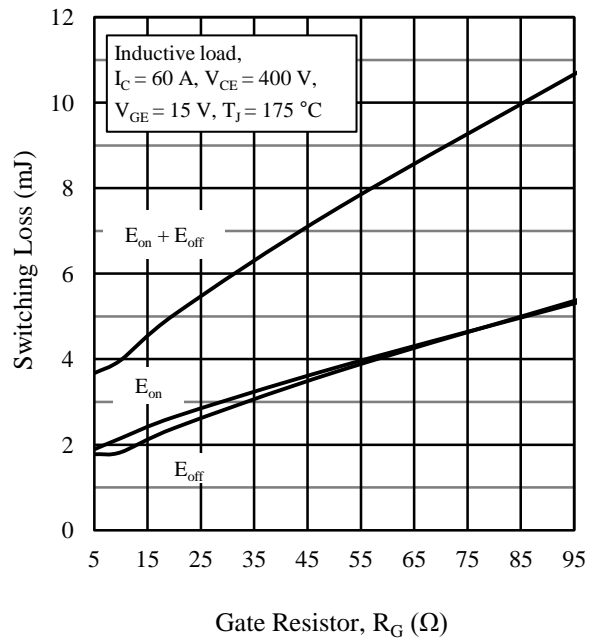

Figure 19. Switching Loss vs. Gate Resistor

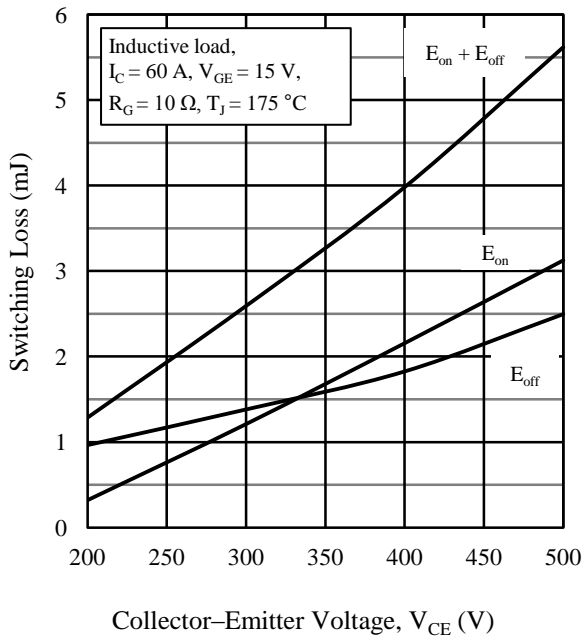

Figure 20. Switching Loss vs. Collector-Emmitter Voltage

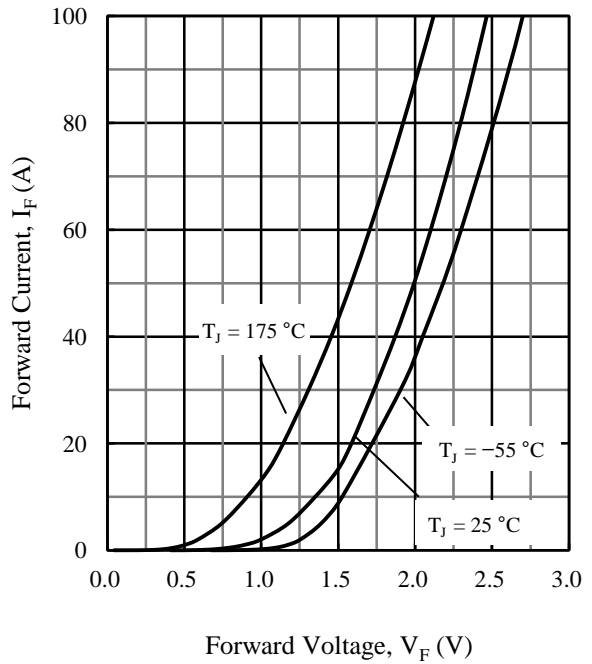

Figure 21. Diode Forward Characteristics

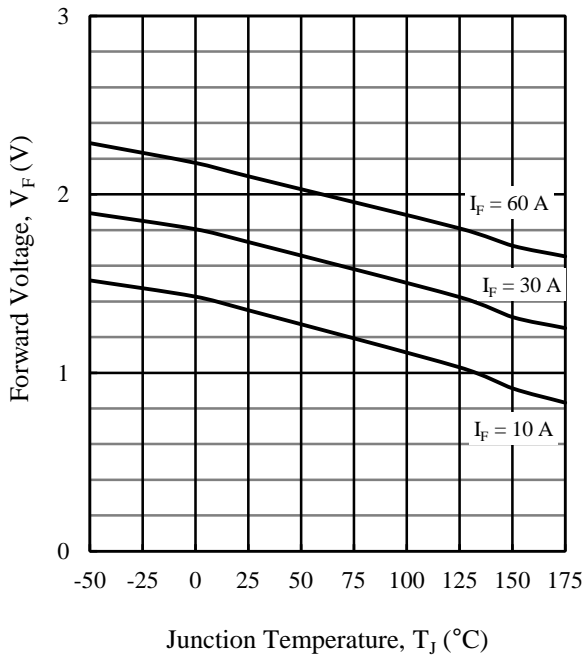

Figure 22. Diode Forward Voltage vs. Junction Temperature

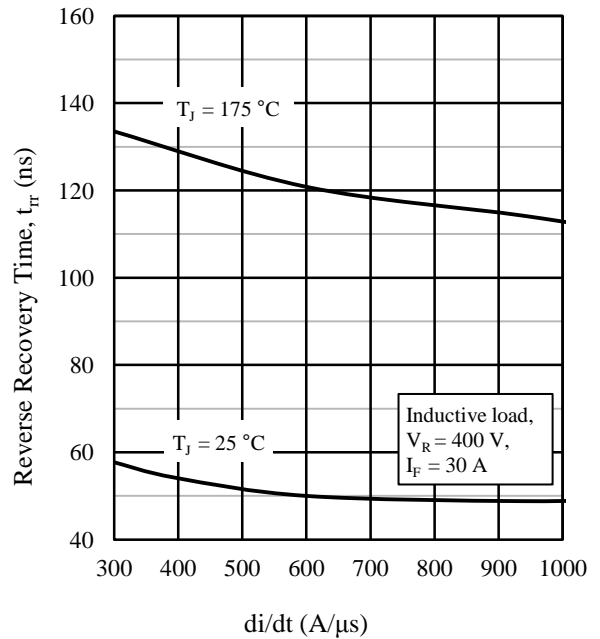

Figure 23. Diode Reverse Recovery Time vs. di/dt

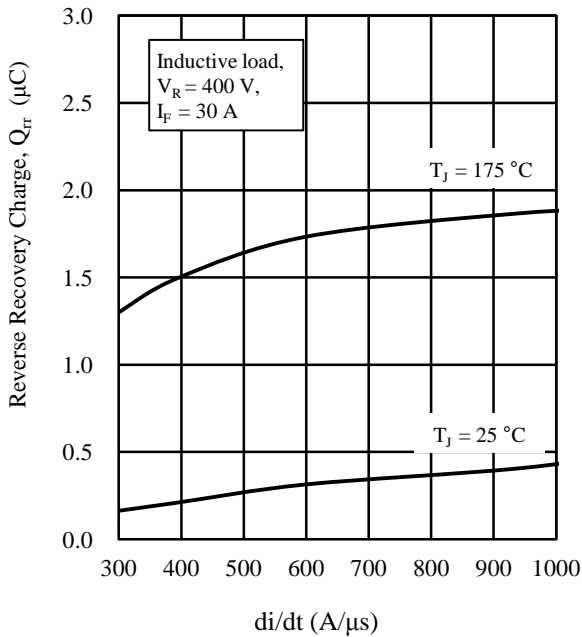

Figure 24. Diode Reverse Recovery Charge vs. di/dt

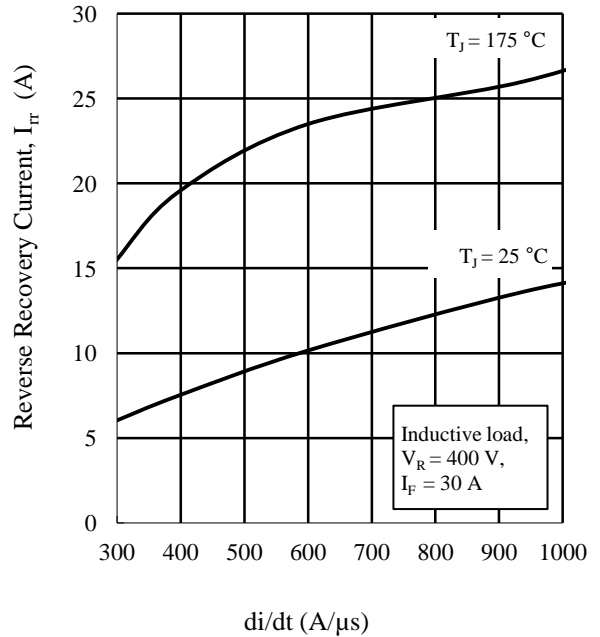

Figure 25. Diode Reverse Recovery Current vs. di/dt

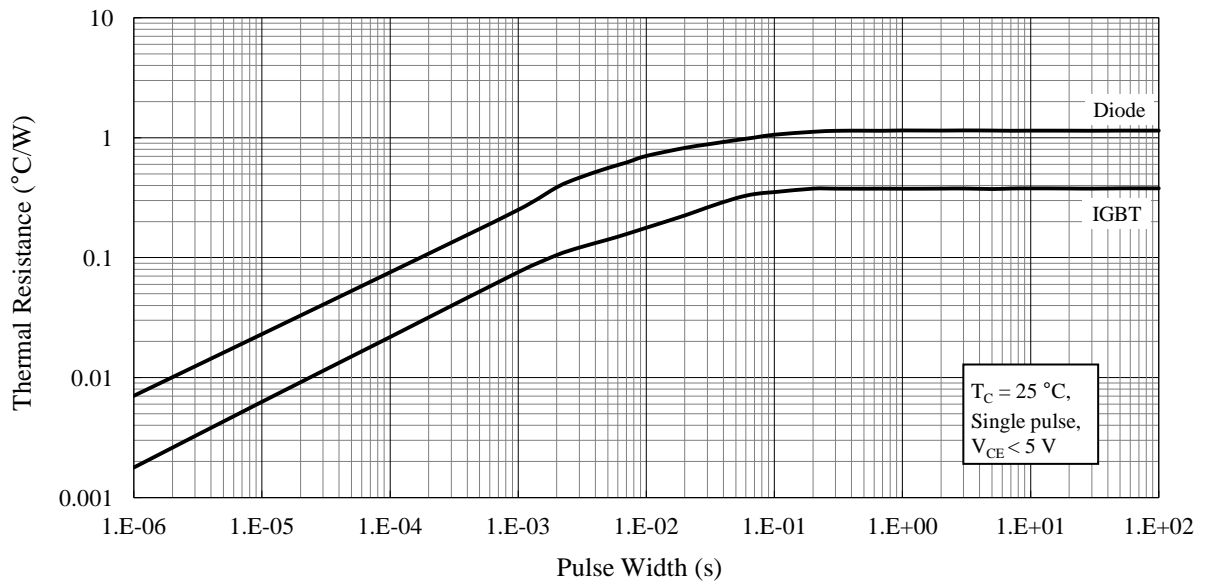
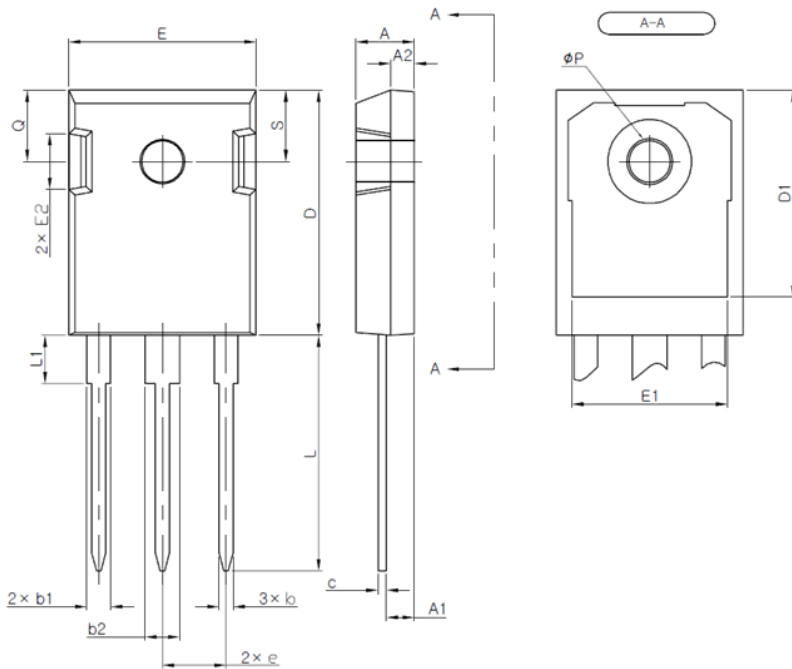

Figure 26. Transient Thermal Resistance

KGF65A6H, MGF65A6H

Physical Dimensions

● TO247-3L



SYMBOL	MIN	NOM	MAX
A	4.83	5.02	5.21
A1	2.29	2.41	2.54
A2	1.91	2.04	2.16
b	1.14	1.27	1.40
b1	1.91	2.10	2.20
b2	2.92	3.10	3.20
c	0.61	0.71	0.80
D	20.80	21.07	21.34
D1	17.43	17.63	17.83
E	15.75	15.94	16.13
E1	13.06	13.26	13.46
E2	4.32	4.58	4.83
e	5.25	5.45	5.65
L	19.81	20.19	20.57
L1	3.81	4.07	4.32
φP	3.55	3.60	3.65
Q	5.59	5.90	6.20
S	6.15 BSC		

NOTE
1. THESE DIMENSION DO NOT INCLUDE MOLD PROTRUSION

● TO3P-3L

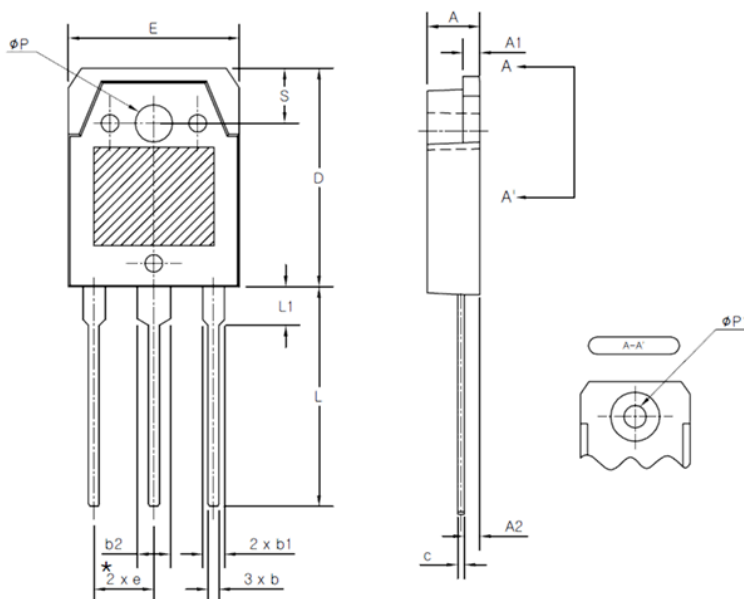

SYMBOL	MIN	NOM	MAX
A	4.60	4.80	5.00
A1	1.45	1.50	1.65
A2	1.20	1.40	1.60
b	0.80	1.00	1.20
b1	1.80	2.00	2.20
b2	2.80	3.00	3.20
c	0.55	0.60	0.75
D	19.70	19.90	20.10
E	15.40	15.60	15.80
*e	5.25	5.45	5.65
L	19.80	20.00	20.20
L1	3.30	3.50	3.70
φP	3.30	3.40	3.50
φP1	3.10	3.20	3.30
S	4.80	5.00	5.20

NOTE
1. THESE DIMENSIONS DO NOT INCLUDE PROTRUSIONS OF THE MOLD.
2. THE (*) MARK IS THE REFERENCE

NOTES:

- All dimensions in millimeters
- Pin treatment for TO247 and TO3P: Pb-free (RoHS compliant)
- When soldering the products, be sure to minimize the working time within the following limits:

260 ± 5 °C	10 ± 1 s, 2 times (flow)
380 ± 10 °C	3.5 ± 0.5 s, 1 time (soldering iron)
- Soldering should be at a distance of at least 1.5 mm from the body of the products.
- The recommended screw torque for TO247, TO3P and TO3PF: 0.686 N·m to 0.882 N·m (7 kgf·cm to 9 kgf·cm)

Marking Diagram

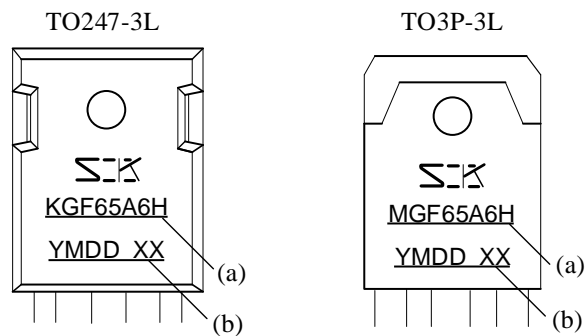

(a) Part Number

(b) Lot Number

Y is the last digit of the year of manufacture (0 to 9)

M is the month of the year (1 to 9, O, N, or D)

DD is the day of the month (01 to 31)

XX is the control number

Important Notes

- All data, illustrations, graphs, tables and any other information included in this document as to Sanken's products listed herein (the "Sanken Products") are current as of the date this document is issued. All contents in this document are subject to any change without notice due to improvement of the Sanken Products, etc. Please make sure to confirm with a Sanken sales representative that the contents set forth in this document reflect the latest revisions before use.
- The Sanken Products are intended for use as components of electronic equipment or apparatus (transportation equipment and its control systems, home appliances, office equipment, telecommunication equipment, measuring equipment, etc.). Prior to use of the Sanken Products, please put your signature, or affix your name and seal, on the specification documents of the Sanken Products and return them to Sanken. If considering use of the Sanken Products for any applications that require higher reliability (traffic signal control systems or equipment, disaster/crime alarm systems, etc.), you must contact a Sanken sales representative to discuss the suitability of such use and put your signature, or affix your name and seal, on the specification documents of the Sanken Products and return them to Sanken, prior to the use of the Sanken Products. The Sanken Products are not intended for use in any applications that require extremely high reliability such as: aerospace equipment; nuclear power control systems; and medical equipment or systems, whose failure or malfunction may result in death or serious injury to people, i.e., medical devices in Class III or a higher class as defined by relevant laws of Japan (collectively, the "Specific Applications"). Sanken assumes no liability or responsibility whatsoever for any and all damages and losses that may be suffered by you, users or any third party, resulting from the use of the Sanken Products in the Specific Applications or in manner not in compliance with the instructions set forth herein.
- In the event of using the Sanken Products by either (i) combining other products or materials therewith or (ii) physically, chemically or otherwise processing or treating the same, you must duly consider all possible risks that may result from all such uses in advance and proceed therewith at your own responsibility.
- Although Sanken is making efforts to enhance the quality and reliability of its products, it is impossible to completely avoid the occurrence of any failure or defect in semiconductor products at a certain rate. You must take, at your own responsibility, preventative measures including using a sufficient safety design and confirming safety of any equipment or systems in/for which the Sanken Products are used, upon due consideration of a failure occurrence rate or derating, etc., in order not to cause any human injury or death, fire accident or social harm which may result from any failure or malfunction of the Sanken Products. Please refer to the relevant specification documents and Sanken's official website in relation to derating.
- No anti-radioactive ray design has been adopted for the Sanken Products.
- No contents in this document can be transcribed or copied without Sanken's prior written consent.
- The circuit constant, operation examples, circuit examples, pattern layout examples, design examples, recommended examples, all information and evaluation results based thereon, etc., described in this document are presented for the sole purpose of reference of use of the Sanken Products and Sanken assumes no responsibility whatsoever for any and all damages and losses that may be suffered by you, users or any third party, or any possible infringement of any and all property rights including intellectual property rights and any other rights of you, users or any third party, resulting from the foregoing.
- All technical information described in this document (the "Technical Information") is presented for the sole purpose of reference of use of the Sanken Products and no license, express, implied or otherwise, is granted hereby under any intellectual property rights or any other rights of Sanken.
- Unless otherwise agreed in writing between Sanken and you, Sanken makes no warranty of any kind, whether express or implied, including, without limitation, any warranty (i) as to the quality or performance of the Sanken Products (such as implied warranty of merchantability, or implied warranty of fitness for a particular purpose or special environment), (ii) that any Sanken Product is delivered free of claims of third parties by way of infringement or the like, (iii) that may arise from course of performance, course of dealing or usage of trade, and (iv) as to any information contained in this document (including its accuracy, usefulness, or reliability).
- In the event of using the Sanken Products, you must use the same after carefully examining all applicable environmental laws and regulations that regulate the inclusion or use of any particular controlled substances, including, but not limited to, the EU RoHS Directive, so as to be in strict compliance with such applicable laws and regulations.
- You must not use the Sanken Products or the Technical Information for the purpose of any military applications or use, including but not limited to the development of weapons of mass destruction. In the event of exporting the Sanken Products or the Technical Information, or providing them for non-residents, you must comply with all applicable export control laws and regulations in each country including the U.S. Export Administration Regulations (EAR) and the Foreign Exchange and Foreign Trade Act of Japan, and follow the procedures required by such applicable laws and regulations.
- Sanken assumes no responsibility for any troubles, which may occur during the transportation of the Sanken Products including the falling thereof, out of Sanken's distribution network.
- Although Sanken has prepared this document with its due care to pursue the accuracy thereof, Sanken does not warrant that it is error free and Sanken assumes no liability whatsoever for any and all damages and losses which may be suffered by you resulting from any possible errors or omissions in connection with the contents included herein.
- Please refer to the relevant specification documents in relation to particular precautions when using the Sanken Products, and refer to our official website in relation to general instructions and directions for using the Sanken Products.
- All rights and title in and to any specific trademark or tradename belong to Sanken or such original right holder(s).

DSGN-AEZ-16002