

T-25-15

# Gate Turn-Off Thyristors

The GTO is a family of asymmetric gate turn-off thyristors designed primarily for dc power switching applications such as motor drives, switching power supplies, inverters, or wherever a need exists for high surge current capabilities and fast switching speeds.

- Fast Turn-Off With Reverse Gate Pulse
- High Voltage —  $V_{DRXM} = 1000$  and  $1200$  Volts
- Momentary Forward Pulse For Turn-On
- Minimizes Drive Losses
- Interdigitated Emitter Geometry Aids Turn-On Current Spreading and Improves Turn-On  $di/dt$
- Clip and Current Spreading Ring for Reliable High Surge Capability —  $I_{TSM} = 200$  A

**MGTO1000**  
**MGTO1200**

**GTOs**  
**18 AMPERES RMS**  
**1000 and 1200 VOLTS**

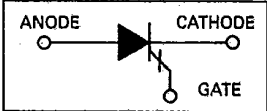
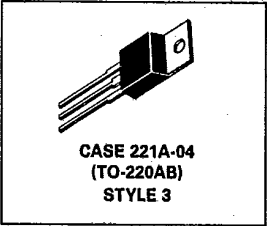

## MAXIMUM RATINGS

Rating	Symbol	Value	Unit
Repetitive Peak Off-State Voltage ( $T_J = -40$ to $+125^\circ\text{C}$ , 1/2 Sine Wave 50 to 60 Hz) Note 1	$V_{DRXM}$	1000 1200	Volts
Repetitive Peak Reverse Voltage, Gate Open ( $T_J = -40$ to $+125^\circ\text{C}$ ), Note 2	$V_{RRM}$	15	Volts
Repetitive Peak Reverse Gate Voltage, Note 3	$V_{GRM}$	15	Volts
On-State Current at $T_C = 65^\circ\text{C}$ (1/2 Cycle Sine Wave, 50 to 60 Hz)	$I_T(\text{RMS})$	18	Amps
Peak Nonrepetitive Surge Current (8.3 ms Conduction, Half Sine Wave $T_C = 65^\circ\text{C}$ )	$I_{TSM}$	200	Amps
Circuit Fusing ( $t = 8.3$ ms)	$I^2t$	167	$\text{A}^2\text{s}$
Repetitive Controllable On-State Current, Note 4	$I_{TCM}$	50	Amps
Nonrepetitive Maximum Interruptable On-State Current, Note 5	$I_{TCSM}$	70	Amps
Peak Forward Gate Power	$P_{GFM}$	10	Watts
Average Forward Gate Power	$P_{GF(AV)}$	3	Watts
Peak Reverse Gate Power	$P_{GRM}$	400	Watts
Average Reverse Gate Power	$P_{GR(AV)}$	5	Watts
Operating Junction Temperature Range	$T_J$	-40 to +125	$^\circ\text{C}$
Storage Temperature Range	$T_{stg}$	-40 to +150	$^\circ\text{C}$

- Notes: 1.  $V_{DRXM}$  for all types can be applied on a continuous basis without damage. Ratings apply for  $R = 39 \Omega$  or shorted gate conditions or negative voltage on the gate. Devices should not be tested for blocking voltage such that the supply voltage exceeds the rating of the device.
2. This is an asymmetric anode shorted part with a blocking gate-cathode junction. The ability to support a reverse voltage depends on the gate-cathode terminal conditions. Gate-cathode reverse bias increases  $V_{RRM}$ .
3. Instantaneous voltage at turn-off may exceed rated  $V_{GRM}$  provided  $P_{GRM}$  is not exceeded.
4.  $V_D$  Maximum Peak =  $V_{DRXM} - 300$  V,  $T_J < 125^\circ\text{C}$ ,  $L_G = 2 \mu\text{H}$ ,  $V_{GR} = 12$  V (See Figure 2)  
 $C_S = 0.1 \mu\text{F}$  for MGTO1000  
 $C_S = 0.05 \mu\text{F}$  for MGTO1200
5.  $V_D$  Maximum Peak =  $V_{DRXM} - 300$  V,  $T_J < 125^\circ\text{C}$ ,  $L_G = 2 \mu\text{H}$ ,  $V_{GR} = 12$  V (See Figure 2)  
 $C_S = 0.2 \mu\text{F}$  for MGTO1000  
 $C_S = 0.1 \mu\text{F}$  for MGTO1200

T-25-15

**THERMAL CHARACTERISTICS**

Characteristic	Symbol	Value	Unit
Thermal Resistance, Junction to Case	R <sub>θJC</sub>	1	°C/W
Thermal Resistance, Junction to Ambient	R <sub>θJA</sub>	60	°C/W

**ELECTRICAL CHARACTERISTICS (T<sub>J</sub> = 25°C unless otherwise noted), Note 1**

Characteristic	Symbol	Min	Typ	Max	Unit
Peak Forward Blocking Current (V <sub>D</sub> = Rated V <sub>DRM</sub> , R <sub>GK</sub> = 39 Ω, T <sub>J</sub> = 125°C)	I <sub>DRM</sub>	—	—	5	mA
Peak On-State Voltage (I <sub>TM</sub> = 50 A, Pulse Width ≤ 300 μs, Duty Cycle ≤ 2%, I <sub>GT</sub> = 300 mAdc)	V <sub>TM</sub>	—	2.7	3.1	Volts
Peak Gate Trigger Current (V <sub>D</sub> = 12 Vdc, R <sub>L</sub> = 1.4 Ω, Pulse Width ≥ 10 μs)	I <sub>GTM</sub>	—	60	300	mA
Peak Gate Trigger Voltage (V <sub>D</sub> = 12 Vdc, R <sub>L</sub> = 1.4 Ω, Pulse Width ≥ 10 μs)	V <sub>GTM</sub>	—	0.8	1.5	Volts
Reverse Gate Leakage Current (V <sub>GRM</sub> = 15 V, T <sub>J</sub> = 125°C)	I <sub>GRM</sub>	—	—	5	mA
Latching Current (PW = 300 μs, f = 60 Hz, Gate Pulse = 1 A, 10 μs, V <sub>D</sub> = 12 Vdc)	I <sub>L</sub>	—	1	—	Adc
Holding Current (PW = 300 μs, f = 60 Hz, Gate Pulse = 1 A, 10 μs, Anode Pulse = 6 A, 100 μs, V <sub>D</sub> = 12 Vdc)	I <sub>H</sub>	—	700	—	mA

**SWITCHING CHARACTERISTICS (T<sub>J</sub> = 25°C unless otherwise noted)**

RESISTIVE TURN-ON SWITCHING						
Gate Turn-On Time	V <sub>D</sub> = 600 V, I <sub>T</sub> = 50 A I <sub>G(pk)</sub> = 6 A, C <sub>S</sub> = 0.1 μF di/dt ≥ 7 A/μs See Figure 1 and Table 1(A)	t <sub>gt</sub>	—	1.5	—	μs
Turn-On Delay Time		t <sub>di</sub>	—	0.6	—	
Rise Time		t <sub>ri</sub>	—	0.9	—	
INDUCTIVE TURN-OFF SWITCHING						
Gate Turn-Off Time	V <sub>D(pk)</sub> = 700 V, I <sub>T</sub> = 50 A, V <sub>GR</sub> = 12 V I <sub>G(pk)</sub> = 6 A L <sub>G</sub> = 2 μH, C <sub>S</sub> = 0.1 μF See Figure 2 and Table 1(B)	t <sub>gq</sub>	—	3	—	μs
Storage Time		T <sub>si</sub>	—	2.6	—	
Fall Time		T <sub>fi</sub>	—	0.4	—	
GATE TURN-OFF CHARGE						
Gate Charge	V <sub>D(pk)</sub> = 700 V, I <sub>T</sub> = 50 A V <sub>GR</sub> = 12 V L <sub>G</sub> = 2 μH, C <sub>S</sub> = 0.1 μF See Table 1(B)	Q <sub>GQ</sub>	—	35	—	μC
Peak Reverse Gate Current		I <sub>GQ</sub>	—	17	—	
Peak Tail Current		I <sub>TLP</sub>	—	5	—	A
STATIC dv/dt						
Critical Exponent of Rise Time	V <sub>(pk)</sub> = V <sub>DRM</sub> - 400 V R <sub>GK</sub> = 39 Ω, T <sub>J</sub> = 125°C Linear Waveform	dv/dt	—	10,000	—	V/μs

3

Note 1. This device is rated for use in applications subject to high surge conditions. Care must be taken to insure proper heat-sinking is used at sustained currents (see derating curves).

T-25-15

TABLE 1 — TERMS, SYMBOLS AND DEFINITIONS FOR SWITCHING WITH GTO'S  
 NOTE: The parameters are shown on two separate graphs for clarity.

Terms	Symbols	Definitions
<b>RESISTIVE TURN-ON SWITCHING</b>		
Turn-On Time	$t_{gt}$	
Delay Time	$t_{di}$	
Rise Time	$t_{ri}$	

(A)

<b>INDUCTIVE TURN-OFF SWITCHING</b>		
Gate Controlled Turn-Off Time	$t_{gq}$	
Current Storage Time	$t_{si}$	
Current Fall Time	$t_{fj}$	
Turn-Off Gate Charge	$Q_{GQ}$	
Peak Tail Current	$I_{TLP}$	

(B)

- $t_{si}$  — current storage time 10%  $I_{GR}$  to 90%  $I_T$
- $t_{fj}$  — current fall time 90%  $I_T$  to  $I_{TLP}$  inflection point
- $t_{gq}$  — gate controlled turn-off time ( $t_{si} + t_{fj}$ )
- $t_{di}$  — current delay time. 10%  $I_{G(pk)}$  to 10%  $I_T$
- $t_{ri}$  — current rise time. 10%  $I_T$  to 90%  $I_T$
- $t_{gt}$  — turn-on time ( $t_{di} + t_{ri}$ )

3

T-25-15

FIGURE 1 — RESISTIVE SWITCHING TEST CIRCUIT (TURN-ON)

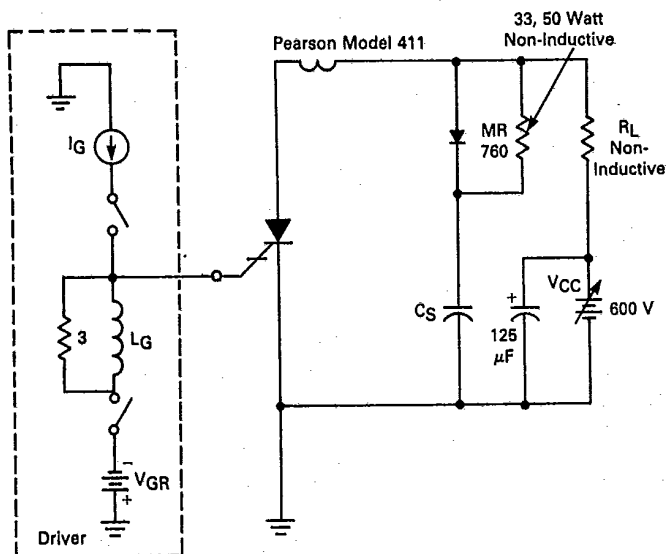

VGR = 12 V  
 IT = 50 A Peak  
 IG(pk) = 6.0 A  $di_g/dt \geq 7.0 A/\mu s$   
 LG = 2.0  $\mu H$   
 CS = 0.1  $\mu F$   
 VCC = Specified Value  
 PW = 150  $\mu s$   
 f = 10 Hz

Adjust RL as required for IT peak.

FIGURE 2 — INDUCTIVE SWITCHING TEST CIRCUIT (TURN-OFF)

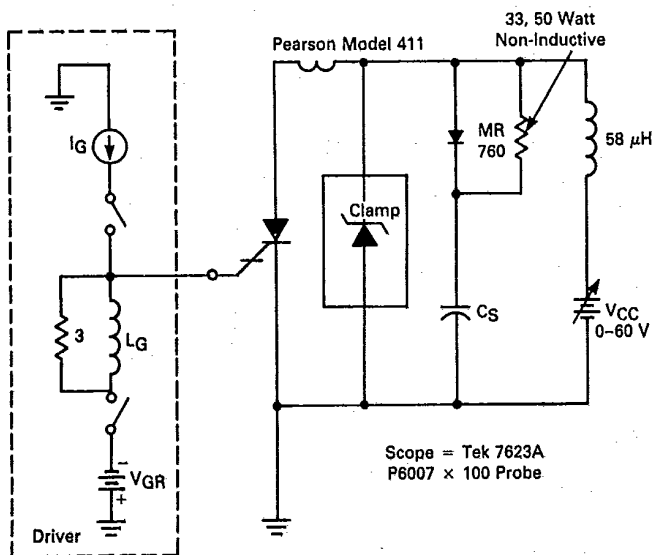

VGR = 12 V  
 IT = 50 A Peak  
 \*LG = 2.0  $\mu H$   
 CS as specified  
 PW = 150  $\mu s$   
 f = 10 Hz  
 Adjust VCC for specified IT

\*LG: 1 Layer Air Core  
 2 3/4" OD 45 Turns No. 14 AWG

Clamp: MOSORB Transient Suppressor  
 Zener Series Stack, 1N6292 or  
 1.5KE75 adjusted for  
 specified V(pk)

Scope = Tek 7623A  
 P6007 x 100 Probe

These circuits are used to evaluate the GTO maximum ratings and switching characteristics

MOSORB is a trademark of Motorola Inc.

3

T-25-15

FIGURE 3 — 50-60 Hz HALF WAVE CURRENT DERATING

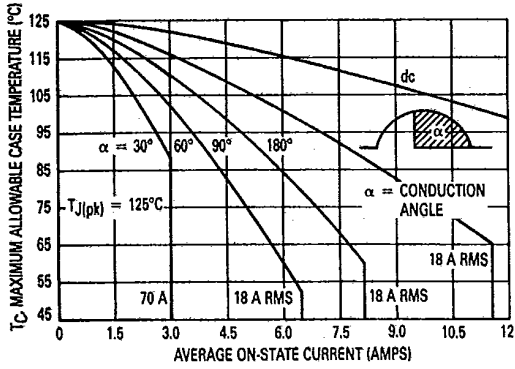

NOTE: Sine wave and rectangular chopper curves allow estimation of heat sink requirements at low frequencies (50 or 60 Hz) where switching losses are low compared to conduction losses. Heat sink sizes should be based on conduction angles that include the worst case peak current as well as the

FIGURE 4 — 50-60 Hz FULL WAVE CURRENT DERATING

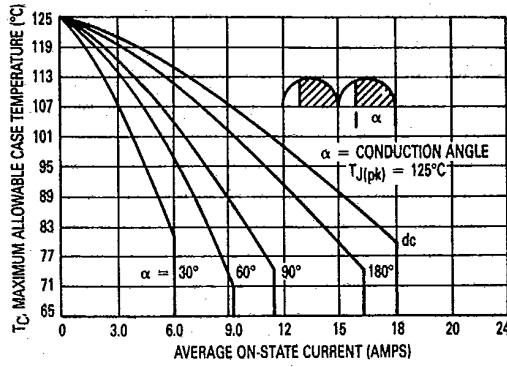

longest conduction time. Operation at high frequencies should also be evaluated using the pulsed rating curves. Surge operation with high power pulses may require determination of the pulse power, energy, and peak T<sub>J</sub> rise to achieve safe turn-off.

FIGURE 5 — CURRENT DERATING 50-60 Hz RECTANGULAR WAVEFORM

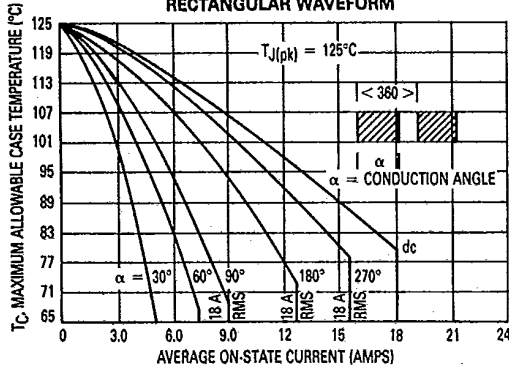

FIGURE 6 — HALF WAVE 50-60 Hz POWER DISSIPATION

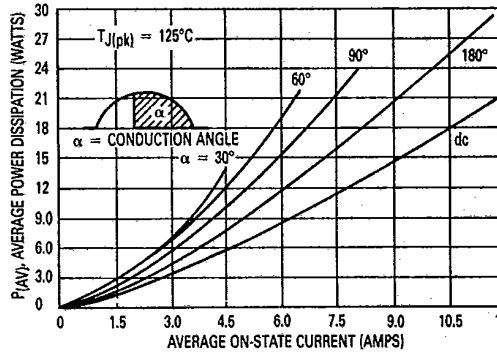

FIGURE 7 — FULL WAVE 50-60 Hz POWER DISSIPATION

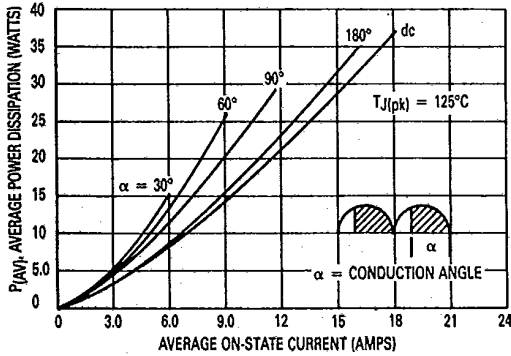
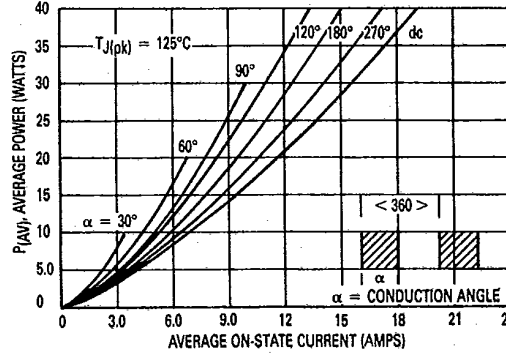

FIGURE 8 — POWER DISSIPATION versus FORWARD CURRENT RECTANGULAR WAVEFORM



3

FIGURE 9 — FIRING CHARACTERISTICS

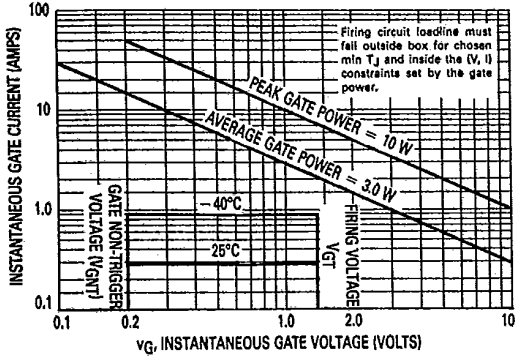

FIGURE 10 — NONREPETITIVE SURGE CHARACTERISTICS

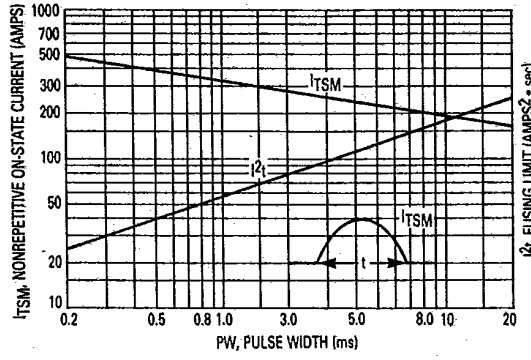

FIGURE 11 — MAXIMUM INTERRUPTABLE CURRENT

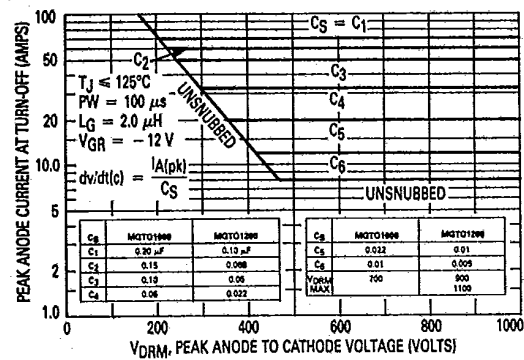
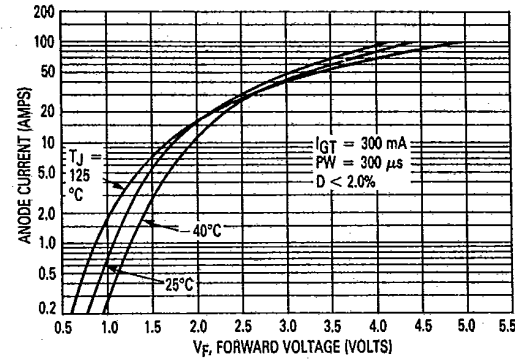

FIGURE 12 — MAXIMUM FORWARD VOLTAGE versus CURRENT



3

NOTE: In bridge inverter configurations the upper and lower snubber capacitors are in parallel, permitting a snubber  $\geq \frac{C_S}{2}$  when stray inductance is kept low. Unsnubbed operation is not recommended although high currents at low voltages can be switched, given well defined load conditions. The use of a small snubber insures that the worst case  $dv/dt$  stress is known.

FIGURE 13 — TYPICAL GATE TRIGGER CURRENT

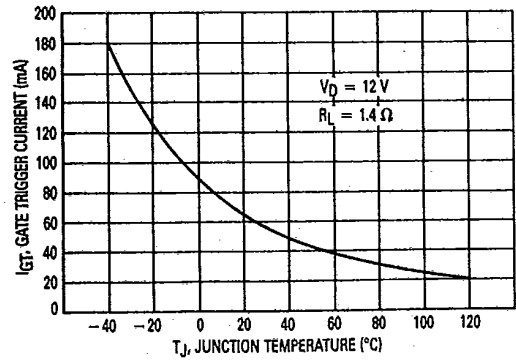
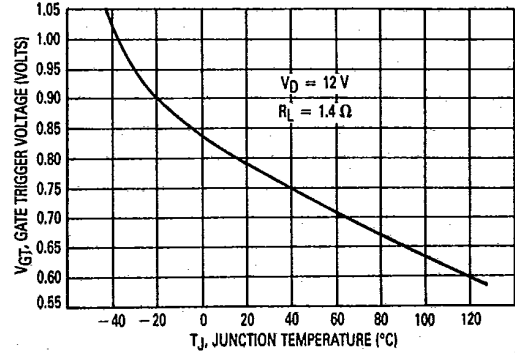

FIGURE 14 — TYPICAL GATE TRIGGER VOLTAGE



T-25-15

FIGURE 15 — THERMAL RESPONSE

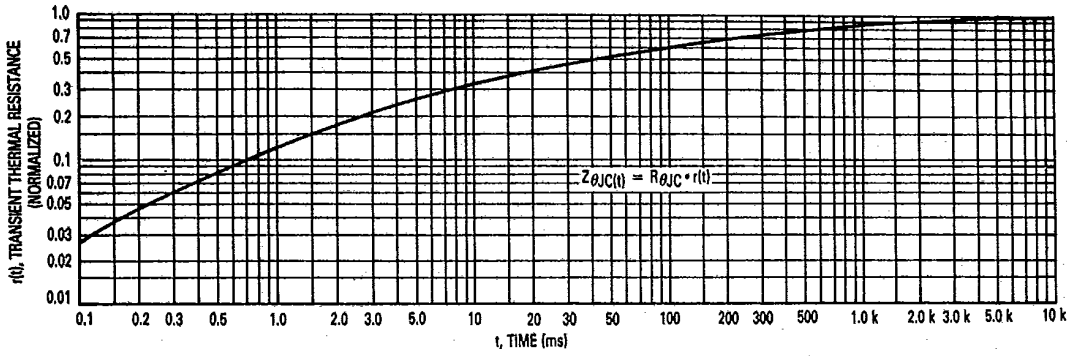

FIGURE 16 — TYPICAL LATCHING CURRENT

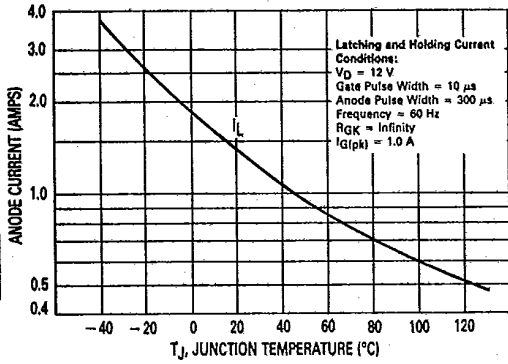
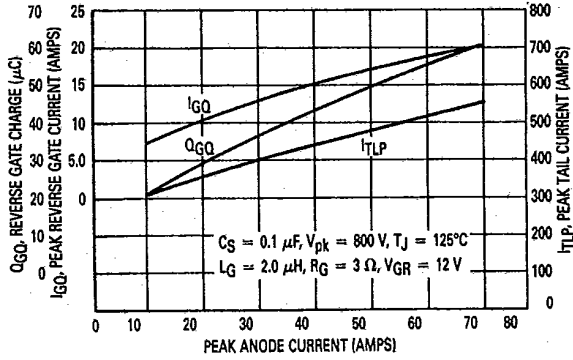

FIGURE 17 — TYPICAL TURN-OFF DYNAMICS



3

FIGURE 18 — TYPICAL TURN-OFF SWITCHING SPEED

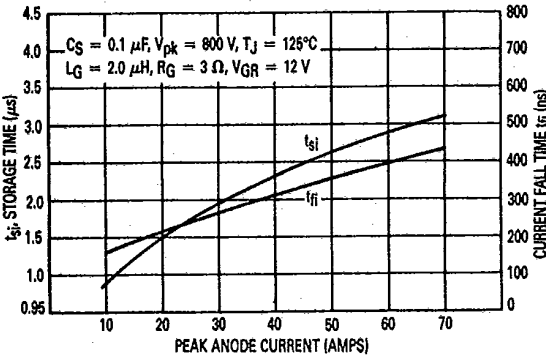

FIGURE 19 — CONDUCTION ENERGY PER PULSE

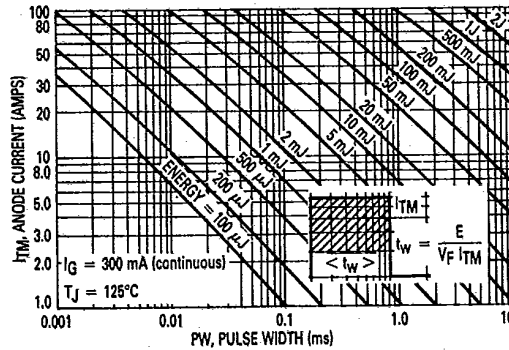

FIGURE 20 — ENERGY PER PULSE AT TURN-ON

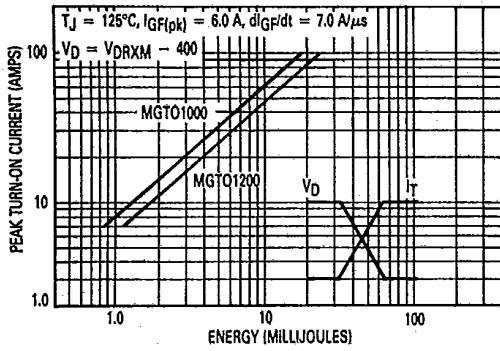

FIGURE 21 — MGTO1000, 1000M TURN-OFF ENERGY (INDUCTIVE LOAD)

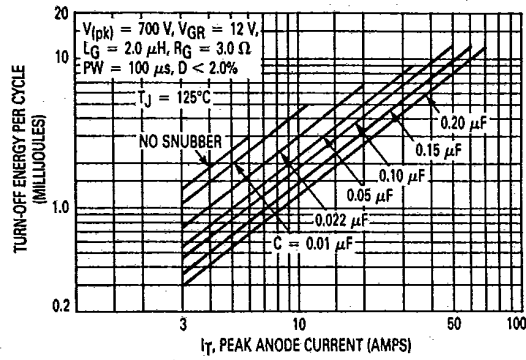

FIGURE 22 — MGTO1200, 1200M, TURN-OFF ENERGY (INDUCTIVE LOAD)

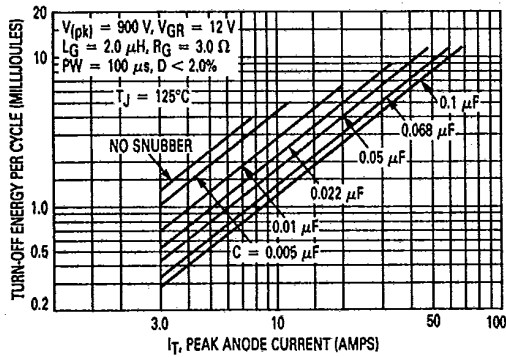
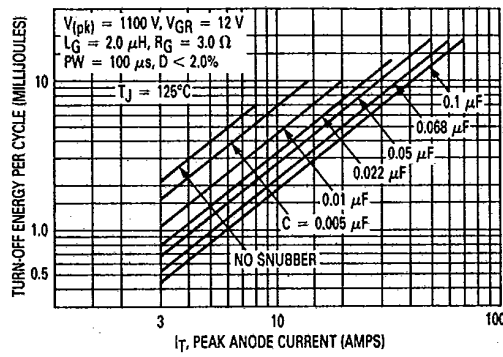

FIGURE 23 — MGTO1400, 1400M, TURN-OFF ENERGY (INDUCTIVE LOAD)



3