

# GaAs Hyperabrupt Varactor Diodes

## MGV Series

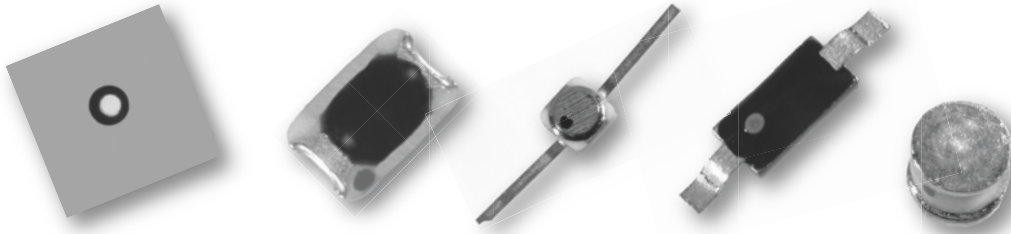

### Description

The MGV series of hyperabrupt varactor diodes feature passivated mesa construction for low leakage and excellent post tuning drift. Available in three constant gamma families of 0.75, 1.0 and 1.25. These diodes will find application in tunable filters and oscillators up to 40 GHz. Optimum performance is obtained using die however packaged devices are available as well diodes screened per MIL-PRF-19500 and MIL-PRF-38534.

### Features

- 0 to 22 Volt tuning voltage
- Tuning ratios up to 10 (typical)
- Three constant gamma families - 0.75, 1.0, and 1.25
- Screening per MIL-PRF-19500 and MIL-PRF-35834 available

### Absolute Maximum Ratings

Parameters	Rating
Reverse Voltage	22 V
Forward Current	100 mA
Power Dissipation	
Chip	250 mW at $T_C = 25\text{ }^\circ\text{C}$ , derate linearly to zero at $T_C = +200\text{ }^\circ\text{C}$
E28, E28X, & 0805-2	100 mW at $T_A = 25\text{ }^\circ\text{C}$ , derate linearly to zero at $T_A = +150\text{ }^\circ\text{C}$
H20, P55 & P55	100 mW at $T_A = 25\text{ }^\circ\text{C}$ , derate linearly to zero at $T_A = +200\text{ }^\circ\text{C}$
Operating Temperature	
Chip	-65 $^\circ\text{C}$ to +200 $^\circ\text{C}$
E28, E28X, & 0805-2	-65 $^\circ\text{C}$ to +150 $^\circ\text{C}$
H20, P55 & P55	-65 $^\circ\text{C}$ to +200 $^\circ\text{C}$
Storage Temperature	Same as operating temperature.
Soldering Temperature	
Chip	+320 $^\circ\text{C}$ for 10 seconds
Packaged	+260 $^\circ\text{C}$ peak per JEDEC J-STD-20C



# GaAs Hyperabrupt Varactor Diodes

## MGV Series, $\Gamma = 0.75 \pm 10\%$

### Chip

Electrical Specifications,  $T_A = 25\text{ }^\circ\text{C}$   $V_{BR} = 22\text{ V min.}$

Model	$I_R$ MAX nA	$C_J$			Tuning Ratio			Q MIN	Package
		MIN pF	NOM pF	MAX pF	MIN	TYP	TYP		
MGV075-08	100	0.25	0.30	0.35	2.2	2.8	3.5	4,000	C01A
MGV075-09	100	0.35	0.40	0.45	2.2	2.8	3.5	4,000	C01A
MGV075-10	100	0.45	0.50	0.55	2.2	2.8	3.5	3,000	C01A
MGV075-11	100	0.63	0.70	0.77	2.2	2.8	3.5	3,000	C01A
MGV075-12	100	0.72	0.80	0.88	2.2	2.8	3.5	3,000	C01A
MGV075-13	100	0.90	1.00	1.10	2.2	2.8	3.5	3,000	C01A
MGV075-14	100	1.08	1.20	1.32	2.2	2.8	3.5	3,000	C01A
MGV075-15	100	1.35	1.50	1.65	2.2	2.8	3.5	3,000	C01A
MGV075-16	100	1.62	1.80	1.98	2.2	2.8	3.5	3,000	C01A
MGV075-17	100	1.80	2.00	2.20	2.2	2.8	3.5	3,000	C01A
Test Conditions	$V_R = 18\text{ V}$	$V_R = 4\text{ V}$ $F = 1\text{ MHz}$			$V_R = 2\text{ to }12\text{ V}$ $F = 1\text{ MHz}$		$V_R = 2\text{ to }20\text{ V}$	$V_R = 4\text{ V}$ $F = 50\text{ MHz}$	

### Typical Performance, Chips

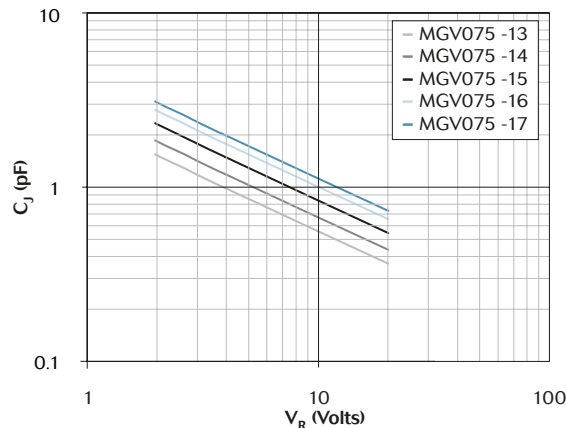
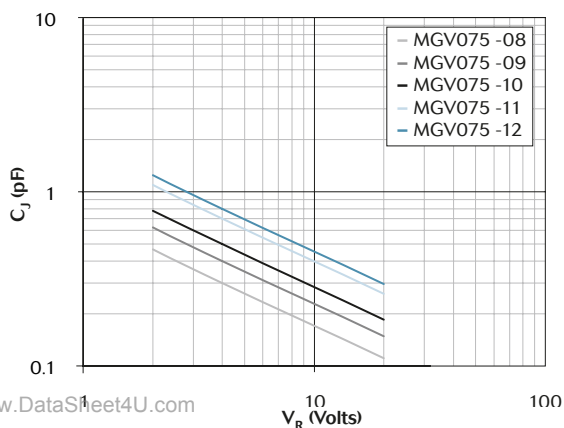

www.DataSheet4U.com

### Outline Drawing

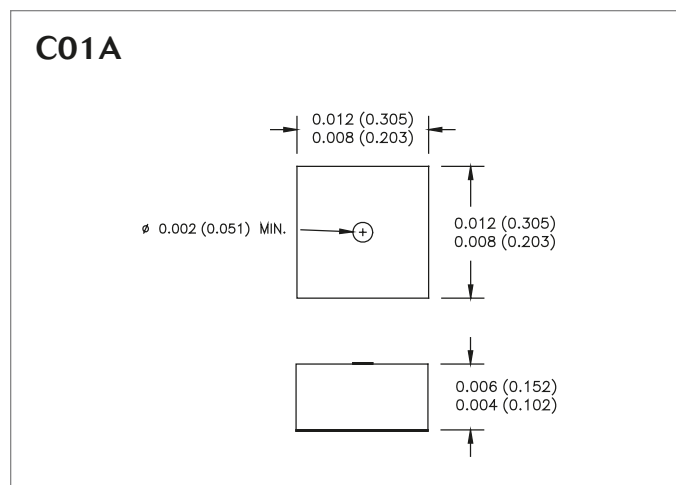

# GaAs Hyperabrupt Varactor Diodes

## MGV Series, $\Gamma = 0.75 \pm 10\%$

### Packaged

Electrical Specifications,  $T_A = 25^\circ\text{C}$   $V_{BR} = 22\text{ V min.}$

Model	$I_R$ MAX nA	$C_T$			Tuning Ratio			Q MIN	$C_P$ TYP pF	$L_P$ TYP nH	Package
		MIN pF	NOM pF	MAX pF	MIN	TYP	TYP				
MGV075-08-E28 / 28 X	100	0.32	0.38	0.44	1.4	2.2	2.7	4,000	0.08	0.4	E28 / 28X
MGV075-08H20	100	0.41	0.48	0.56	0.4	1.4	1.7	4,000	0.18	0.5	H20
MGV075-08-P55	100	0.36	0.43	0.50	0.9	1.8	2.2	4,000	0.13	0.35	P55
MGV075-08-0805-2	100	0.30	0.36	0.42	1.6	2.3	2.9	4,000	0.06	0.4	0805-2
MGV075-09-E28 / 28 X	100	0.42	0.48	0.54	1.6	2.3	2.9	4,000	0.08	0.4	E28 / 28X
MGV075-09-H20	100	0.51	0.58	0.66	0.9	1.7	2.1	4,000	0.18	0.5	H20
MGV075-09-P55	100	0.46	0.53	0.60	1.3	2.0	2.5	4,000	0.13	0.35	P55
MGV075-09-0805-2	100	0.40	0.46	0.52	1.8	2.4	3.0	4,000	0.06	0.4	0805-2
MGV075-10-E28 / 28 X	100	0.52	0.58	0.64	1.8	2.4	3.0	3,000	0.08	0.4	E28 / 28X
MGV075-10-H20	100	0.61	0.68	0.76	1.2	1.9	2.4	3,000	0.18	0.5	H20
MGV075-10-P55	100	0.56	0.63	0.70	1.5	2.1	2.7	3,000	0.13	0.35	P55
MGV075-10-0805-2	100	0.50	0.56	0.62	1.9	2.5	3.1	3,000	0.06	0.4	0805-2
MGV075-11-E28 / 28 X	100	0.70	0.78	0.86	1.9	2.5	3.1	3,000	0.08	0.4	E28 / 28X
MGV075-11-H20	100	0.79	0.88	0.98	1.5	2.1	2.7	3,000	0.18	0.5	H20
MGV075-11-P55	100	0.74	0.83	0.92	1.7	2.3	2.9	3,000	0.13	0.35	P55
MGV075-11-0805-2	100	0.68	0.76	0.84	2.0	2.6	3.2	3,000	0.06	0.4	0805-2
MGV075-12-E28 / 28 X	100	0.79	0.88	0.97	1.9	2.5	3.2	3,000	0.08	0.4	E28 / 28X
MGV075-12-H20	100	0.88	0.98	1.09	1.6	2.2	2.8	3,000	0.18	0.5	H20
MGV075-12-P55	100	0.83	0.93	1.03	1.7	2.4	3.0	3,000	0.13	0.35	P55
MGV075-12-0805-2	100	0.77	0.86	0.95	2.0	2.6	3.3	3,000	0.06	0.4	0805-2
MGV075-13-E28 / 28 X	100	0.97	1.08	1.19	2.0	2.6	3.2	3,000	0.08	0.4	E28 / 28X
MGV075-13-H20	100	1.06	1.18	1.31	1.7	2.3	2.9	3,000	0.18	0.5	H20
MGV075-13-P55	100	1.01	1.13	1.25	1.8	2.5	3.1	3,000	0.13	0.35	P55
MGV075-13-0805-2	100	0.95	1.06	1.17	2.0	2.6	3.3	3,000	0.06	0.4	0805-2
MGV075-14-E28 / 28 X	100	1.15	1.28	1.41	2.0	2.6	3.3	3,000	0.08	0.4	E28 / 28X
MGV075-14-H20	100	1.24	1.38	1.53	1.8	2.4	3.0	3,000	0.18	0.5	H20
MGV075-14-P55	100	1.19	1.33	1.47	1.9	2.5	3.2	3,000	0.13	0.35	P55
MGV075-14-0805-2	100	1.13	1.26	1.39	2.1	2.7	3.3	3,000	0.06	0.4	0805-2
MGV075-15-E28 / 28 X	100	1.42	1.58	1.74	2.1	2.7	3.3	3,000	0.08	0.4	E28 / 28X
MGV075-15-H20	100	1.51	1.68	1.86	1.9	2.5	3.1	3,000	0.18	0.5	H20
MGV075-15-P55	100	1.46	1.63	1.80	2.0	2.6	3.2	3,000	0.13	0.35	P55
MGV075-15-0805-2	100	1.40	1.56	1.72	2.1	2.7	3.4	3,000	0.06	0.4	0805-2
MGV075-16-E28 / 28 X	100	1.69	1.88	2.07	2.1	2.7	3.4	3,000	0.08	0.4	E28 / 28X
MGV075-16-H20	100	1.78	1.98	2.19	1.9	2.5	3.2	3,000	0.18	0.5	H20
MGV075-16-P55	100	1.73	1.93	2.13	2.0	2.6	3.3	3,000	0.13	0.35	P55
MGV075-16-0805-2	100	1.67	1.86	2.05	2.1	2.7	3.4	3,000	0.06	0.4	0805-2
MGV075-17-E28 / 28 X	100	1.87	2.08	2.29	2.1	2.7	3.4	3,000	0.08	0.4	E28 / 28X
MGV075-17-H20	100	1.96	2.18	2.41	1.9	2.6	3.2	3,000	0.18	0.5	H20
MGV075-17-P55	100	1.91	2.13	2.35	2.0	2.6	3.3	3,000	0.13	0.35	P55
MGV075-17-0805-2	100	1.85	2.06	2.27	2.1	2.7	3.4	3,000	0.06	0.4	0805-2
<b>Test Conditions</b>	$V_R = 18\text{ V}$	$V_R = 4\text{ V}$ $F = 1\text{ MHz}$			$V_R = 2\text{ to }12$		$V_R = 2\text{ to }20$	$V_R = 4\text{ V}$ $F = 50\text{ MHz}$	$F = 1\text{ GHz}$		



# GaAs Hyperabrupt Varactor Diodes

## MGV Series, $\Gamma = 1.00 \pm 10\%$

### Chip

Electrical Specifications,  $T_A = 25\text{ }^\circ\text{C}$   $V_{BR} = 22\text{ V min.}$

Model	$I_R$ MAX nA	$C_J$			Tuning Ratio			Q MIN	Package
		MIN pF	NOM pF	MAX pF	MIN	TYP	TYP		
MGV100-08	100	0.30	0.35	0.40	2.7	3.4	5.0	4,000	C01A
MGV100-09	100	0.40	0.45	0.50	2.7	3.4	5.0	4,000	C01A
MGV100-20	100	0.50	0.55	0.61	2.7	3.4	5.0	4,000	C01A
MGV100-21	100	0.58	0.65	0.72	2.7	3.4	5.0	4,000	C01A
MGV100-22	100	0.72	0.80	0.88	2.7	3.4	5.0	3,000	C01A
MGV100-23	100	0.90	1.00	1.10	2.7	3.4	5.0	3,000	C01A
MGV100-24	100	1.08	1.20	1.32	2.7	3.4	5.0	3,000	C01A
MGV100-25	100	1.35	1.50	1.65	2.7	3.4	5.0	3,000	C01A
MGV100-26	100	1.63	1.70	1.87	2.7	3.4	5.0	3,000	C01A
MGV100-27	100	1.80	2.00	2.20	2.7	3.4	5.0	3,000	C01A
Test Conditions	$V_R = 18\text{ V}$	$V_R = 4\text{ V}$ $F = 1\text{ MHz}$			$V_R = 2\text{ to }12\text{ V}$ $F = 1\text{ MHz}$		$V_R = 2\text{ to }20\text{ V}$	$V_R = 4\text{ V}$ $F = 50\text{ MHz}$	

### Typical Performance, Chips

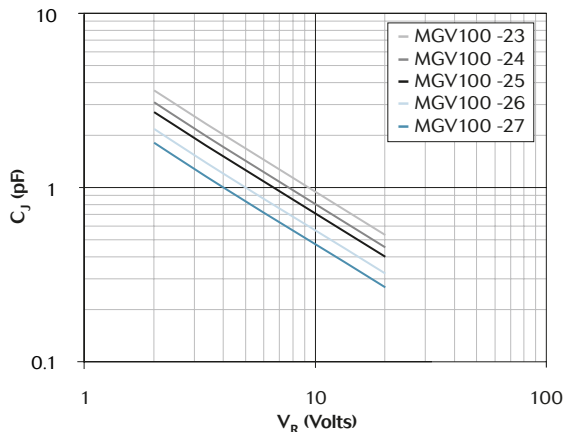
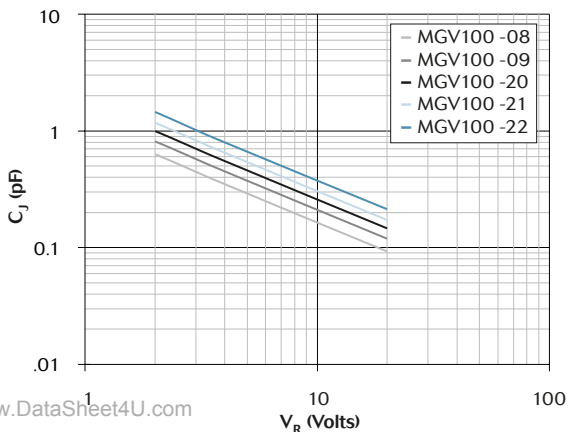

### Outline Drawing

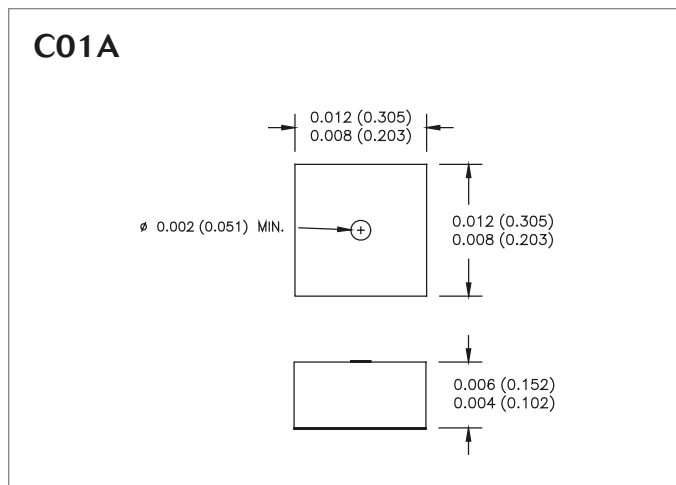

# GaAs Hyperabrupt Varactor Diodes

## MGV Series, $\Gamma = 1.00 \pm 10\%$

### Packaged

Electrical Specifications,  $T_A = 25^\circ\text{C}$   $V_{BR} = 22\text{ V min.}$

Model	$I_R$ MAX nA	$C_T$			Tuning Ratio			Q MIN	$C_P$ TYP pF	$L_P$ TYP nH	Package
		MIN pF	NOM pF	MAX pF	MIN	TYP	TYP				
MGV100-08-E28 / 28 X	100	0.37	0.43	0.49	1.9	2.7	4.0	4,000	0.08	0.4	E28 / 28X
MGV100-08H20	100	0.46	0.53	0.61	0.8	1.9	2.8	4,000	0.18	0.5	H20
MGV100-08-P55	100	0.41	0.48	0.55	1.4	2.3	3.4	4,000	0.13	0.35	P55
MGV100-08-0805-2	100	0.35	0.41	0.47	2.1	2.9	4.3	4,000	0.06	0.4	0805-2
MGV100-09-E28 / 28 X	100	0.47	0.53	0.59	2.1	2.9	4.2	4,000	0.08	0.4	E28 / 28X
MGV100-09-H20	100	0.56	0.63	0.71	1.3	2.2	3.2	4,000	0.18	0.5	H20
MGV100-09-P55	100	0.51	0.58	0.65	1.7	2.5	3.7	4,000	0.13	0.35	P55
MGV100-09-0805-2	100	0.45	0.51	0.57	2.2	3.0	4.4	4,000	0.06	0.4	0805-2
MGV100-20-E28 / 28 X	100	0.57	0.63	0.70	2.2	3.0	4.3	4,000	0.08	0.4	E28 / 28X
MGV100-20-H20	100	0.66	0.73	0.82	1.6	2.4	3.5	4,000	0.18	0.5	H20
MGV100-20-P55	100	0.61	0.68	0.76	1.9	2.7	3.9	4,000	0.13	0.35	P55
MGV100-20-0805-2	100	0.55	0.61	0.68	2.3	3.1	4.5	4,000	0.06	0.4	0805-2
MGV100-21-E28 / 28 X	100	0.65	0.73	0.81	2.3	3.0	4.4	4,000	0.08	0.4	E28 / 28X
MGV100-21-H20	100	0.74	0.83	0.93	1.7	2.6	3.8	4,000	0.18	0.5	H20
MGV100-21-P55	100	0.69	0.78	0.87	2.0	2.8	4.1	4,000	0.13	0.35	P55
MGV100-21-0805-2	100	0.63	0.71	0.79	2.4	3.1	4.6	4,000	0.06	0.4	0805-2
MGV100-22-E28 / 28 X	100	0.79	0.88	0.97	2.4	3.1	4.5	3,000	0.08	0.4	E28 / 28X
MGV100-22-H20	100	0.88	0.98	1.09	1.9	2.7	4.0	3,000	0.18	0.5	H20
MGV100-22-P55	100	0.83	0.93	1.03	2.1	2.9	4.3	3,000	0.13	0.35	P55
MGV100-22-0805-2	100	0.77	0.86	0.95	2.4	3.2	4.7	3,000	0.06	0.4	0805-2
MGV100-23-E28 / 28 X	100	0.97	1.08	1.19	2.4	3.2	4.6	3,000	0.08	0.4	E28 / 28X
MGV100-23-H20	100	1.06	1.18	1.31	2.1	2.8	4.2	3,000	0.18	0.5	H20
MGV100-23-P55	100	1.01	1.13	1.25	2.3	3.0	4.4	3,000	0.13	0.35	P55
MGV100-23-0805-2	100	0.95	1.06	1.17	2.5	3.2	4.7	3,000	0.06	0.4	0805-2
MGV100-24-E28 / 28 X	100	1.15	1.28	1.41	2.5	3.2	4.7	3,000	0.08	0.4	E28 / 28X
MGV100-24-H20	100	1.24	1.38	1.53	2.2	2.9	4.3	3,000	0.18	0.5	H20
MGV100-24-P55	100	1.19	1.33	1.47	2.3	3.1	4.5	3,000	0.13	0.35	P55
MGV100-24-0805-2	100	1.13	1.26	1.39	2.5	3.2	4.8	3,000	0.06	0.4	0805-2
MGV100-25-E28 / 28 X	100	1.42	1.58	1.74	2.5	3.2	4.8	3,000	0.08	0.4	E28 / 28X
MGV100-25-H20	100	1.51	1.68	1.86	2.3	3.0	4.5	3,000	0.18	0.5	H20
MGV100-25-P55	100	1.46	1.63	1.80	2.4	3.1	4.6	3,000	0.13	0.35	P55
MGV100-25-0805-2	100	1.40	1.56	1.72	2.6	3.3	4.8	3,000	0.06	0.4	0805-2
MGV100-26-E28 / 28 X	100	1.70	1.78	1.96	2.5	3.3	4.8	3,000	0.08	0.4	E28 / 28X
MGV100-26-H20	100	1.79	1.88	2.08	2.4	3.1	4.5	3,000	0.18	0.5	H20
MGV100-26-P55	100	1.74	1.83	2.02	2.5	3.2	4.7	3,000	0.13	0.35	P55
MGV100-26-0805-2	100	1.68	1.76	1.94	2.6	3.3	4.8	3,000	0.06	0.4	0805-2
MGV100-27-E28 / 28 X	100	1.87	2.08	2.29	2.6	3.3	4.8	3,000	0.08	0.4	E28 / 28X
MGV100-27-H20	100	1.96	2.18	2.41	2.4	3.1	4.6	3,000	0.18	0.5	H20
MGV100-27-P55	100	1.91	2.13	2.35	2.5	3.2	4.7	3,000	0.13	0.35	P55
MGV100-27-0805-2	100	1.85	2.06	2.27	2.6	3.3	4.9	3,000	0.06	0.4	0805-2
<b>Test Conditions</b>	$V_R = 18\text{ V}$	$V_R = 4\text{ V}$ $F = 1\text{ MHz}$			$V_R = 2\text{ to }12$		$V_R = 2\text{ to }20$	$V_R = 4\text{ V}$ $F = 50\text{ MHz}$	$F = 1\text{ GHz}$		



# GaAs Hyperabrupt Varactor Diodes

## MGV Series, $\Gamma = 1.25 \pm 10\%$

### Chip

Electrical Specifications,  $T_A = 25\text{ }^\circ\text{C}$   $V_{BR} = 22\text{ V min.}$

Model	$I_R$ MAX nA	$C_J$			Tuning Ratio			Q MIN	Package
		MIN pF	NOM pF	MAX pF	MIN	TYP	TYP		
MGV125-08	100	0.25	0.30	0.35	4.0	5.0	8.4	4,000	C01A
MGV125-09	100	0.35	0.40	0.45	4.0	5.0	8.5	4,000	C01A
MGV125-20	100	0.45	0.50	0.55	4.0	5.0	8.6	4,000	C01A
MGV125-21	100	0.63	0.70	0.77	4.0	5.0	8.8	4,000	C01A
MGV125-22	100	0.90	1.00	1.10	4.0	5.0	9.0	3,000	C01A
MGV125-23	100	1.08	1.20	1.32	4.0	5.0	9.5	3,000	C01A
MGV125-24	100	1.35	1.50	1.65	4.0	5.0	10	3,000	C01A
MGV125-25	100	1.63	1.70	1.87	4.0	5.0	10	3,000	C01A
MGV125-26	100	1.80	2.00	2.20	4.0	5.0	10	3,000	C01A
Test Conditions	$V_R = 18\text{ V}$	$V_R = 4\text{ V}$ $F = 1\text{ MHz}$			$V_R = 2\text{ to }12\text{ V}$ $F = 1\text{ MHz}$		$V_R = 2\text{ to }20\text{ V}$	$V_R = 4\text{ V}$ $F = 50\text{ MHz}$	

### Typical Performance, Chips

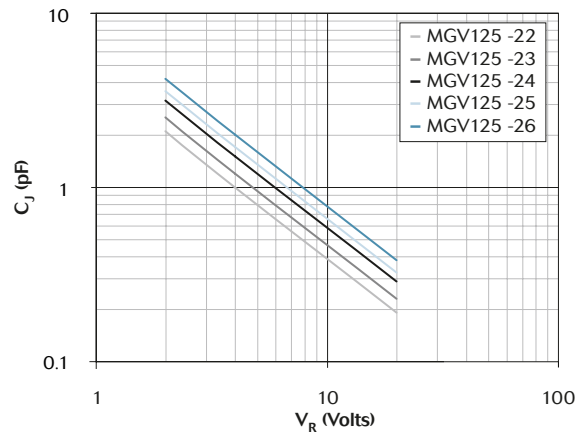
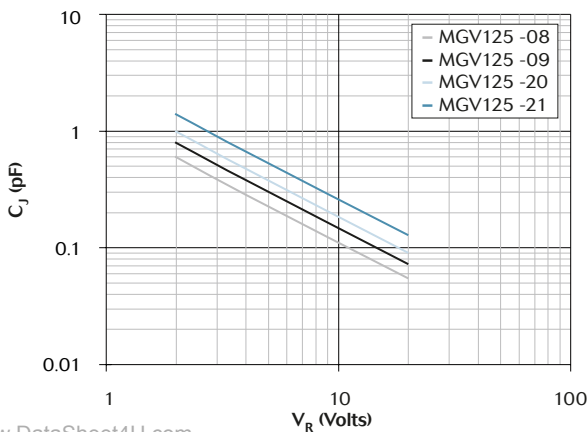

www.DataSheet4U.com

### Outline Drawing

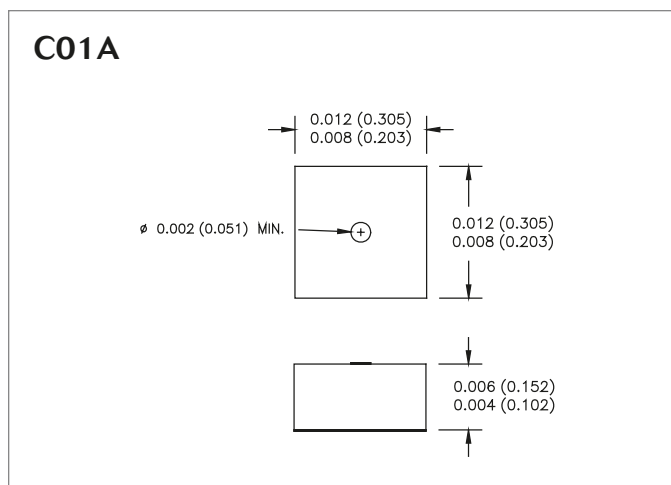

# GaAs Hyperabrupt Varactor Diodes

## MGV Series, $\Gamma = 1.25 \pm 10\%$

### Packaged

Electrical Specifications,  $T_A = 25^\circ\text{C}$   $V_{BR} = 22\text{ V min.}$

Model	$I_R$ MAX nA	$C_T$			Tuning Ratio			Q MIN	$C_P$ TYP pF	$L_P$ TYP nH	Package
		MIN pF	NOM pF	MAX pF	MIN	TYP	TYP				
MGV125-08-E28 / 28 X	100	0.32	0.38	0.44	2.5	3.9	6.5	4,000	0.08	0.4	E28 / 28X
MGV125-08H20	100	0.41	0.48	0.56	0.7	2.4	4.1	4,000	0.18	0.5	H20
MGV125-08-P55	100	0.36	0.43	0.50	1.6	3.1	5.3	4,000	0.13	0.35	P55
MGV125-08-0805-2	100	0.30	0.36	0.42	2.9	4.1	7.0	4,000	0.06	0.4	0805-2
MGV125-09-E28 / 28 X	100	0.42	0.48	0.54	2.9	4.1	7.0	4,000	0.08	0.4	E28 / 28X
MGV125-09-H20	100	0.51	0.58	0.66	1.6	3.0	5.1	4,000	0.18	0.5	H20
MGV125-09-P55	100	0.46	0.53	0.60	2.3	3.6	6.0	4,000	0.13	0.35	P55
MGV125-09-0805-2	100	0.40	0.46	0.52	3.2	4.3	7.4	4,000	0.06	0.4	0805-2
MGV125-20-E28 / 28 X	100	0.52	0.58	0.64	3.2	4.3	7.3	4,000	0.08	0.4	E28 / 28X
MGV125-20-H20	100	0.61	0.68	0.76	2.2	3.4	5.8	4,000	0.18	0.5	H20
MGV125-20-P55	100	0.56	0.63	0.70	2.7	3.8	6.6	4,000	0.13	0.35	P55
MGV125-20-0805-2	100	0.50	0.56	0.62	3.4	4.5	7.7	4,000	0.06	0.4	0805-2
MGV125-21-E28 / 28 X	100	0.70	0.78	0.86	3.4	4.5	7.9	4,000	0.08	0.4	E28 / 28X
MGV125-21-H20	100	0.79	0.88	0.98	2.7	3.8	6.7	4,000	0.18	0.5	H20
MGV125-21-P55	100	0.74	0.83	0.92	3.1	4.2	7.3	4,000	0.13	0.35	P55
MGV125-21-0805-2	100	0.68	0.76	0.84	3.6	4.6	8.1	4,000	0.06	0.4	0805-2
MGV125-22-E28 / 28 X	100	0.97	1.08	1.19	3.6	4.6	8.3	3,000	0.08	0.4	E28 / 28X
MGV125-22-H20	100	1.06	1.18	1.31	3.1	4.2	7.5	3,000	0.18	0.5	H20
MGV125-22-P55	100	1.01	1.13	1.25	3.3	4.4	7.9	3,000	0.13	0.35	P55
MGV125-22-0805-2	100	0.95	1.06	1.17	3.7	4.7	8.5	3,000	0.06	0.4	0805-2
MGV125-23-E28 / 28 X	100	1.15	1.28	1.41	3.7	4.7	8.9	3,000	0.08	0.4	E28 / 28X
MGV125-23-H20	100	1.24	1.38	1.53	3.2	4.3	8.2	3,000	0.18	0.5	H20
MGV125-23-P55	100	1.19	1.33	1.47	3.4	4.5	8.6	3,000	0.13	0.35	P55
MGV125-23-0805-2	100	1.13	1.26	1.39	3.7	4.8	9.1	3,000	0.06	0.4	0805-2
MGV125-24-E28 / 28 X	100	1.42	1.58	1.74	3.7	4.8	9.5	3,000	0.08	0.4	E28 / 28X
MGV125-24-H20	100	1.51	1.68	1.86	3.4	4.5	8.9	3,000	0.18	0.5	H20
MGV125-24-P55	100	1.46	1.63	1.80	3.6	4.6	9.2	3,000	0.13	0.35	P55
MGV125-24-0805-2	100	1.40	1.56	1.72	3.8	4.8	9.6	3,000	0.06	0.4	0805-2
MGV125-25-E28 / 28 X	100	1.70	1.78	1.96	3.8	4.8	9.6	3,000	0.08	0.4	E28 / 28X
MGV125-25-H20	100	1.79	1.88	2.08	3.5	4.5	9.0	3,000	0.18	0.5	H20
MGV125-25-P55	100	1.74	1.83	2.02	3.6	4.7	9.3	3,000	0.13	0.35	P55
MGV125-25-0805-2	100	1.68	1.76	1.94	3.8	4.8	9.7	3,000	0.06	0.4	0805-2
MGV125-26-E28 / 28 X	100	1.87	2.08	2.29	3.8	4.8	9.6	3,000	0.08	0.4	E28 / 28X
MGV125-26-H20	100	1.96	2.18	2.41	3.5	4.6	9.2	3,000	0.18	0.5	H20
MGV125-26-P55	100	1.91	2.13	2.35	3.7	4.7	9.4	3,000	0.13	0.35	P55
MGV125-26-0805-2	100	1.85	2.06	2.27	3.8	4.9	9.7	3,000	0.06	0.4	0805-2
<b>Test Conditions</b>	$V_R = 18\text{ V}$	$V_R = 4\text{ V}$ $F = 1\text{ MHz}$			$V_R = 2\text{ to }12$		$V_R = 2\text{ to }20$	$V_R = 4\text{ V}$ $F = 50\text{ MHz}$	$F = 1\text{ GHz}$		

## Outline Drawings

### E28 (non-hermetic)

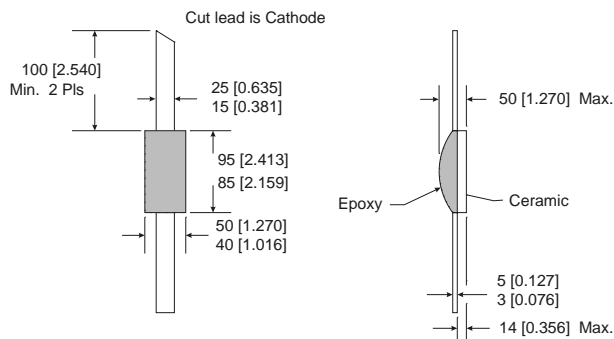

### H20 (hermetic)

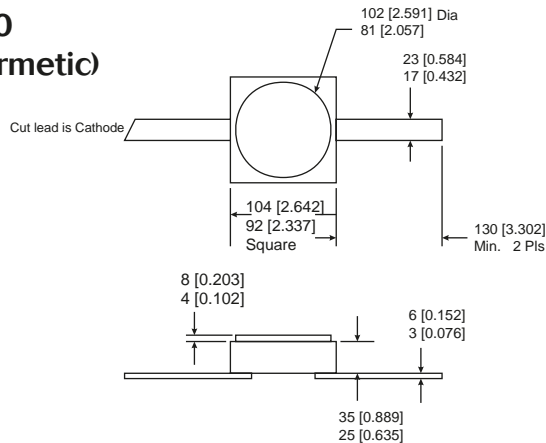

### P55 (hermetic)

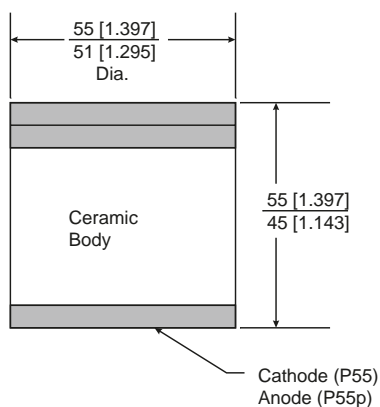

www.DataSheet4U.com

### 0805-02 (non-hermetic)

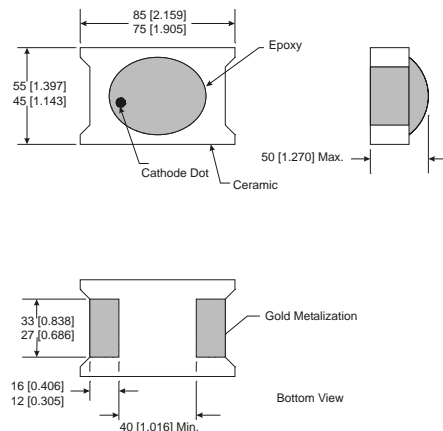

#### Aeroflex / Metelics

Aeroflex Microelectronic Solutions  
975 Stewart Drive, Sunnyvale, CA 94085  
TEL: 408-737-8181  
Fax: 408-733-7645

[www.aeroflex-metelics.com](http://www.aeroflex-metelics.com)

[sales@eroflex-metelics.com](mailto:sales@eroflex-metelics.com)



Aeroflex / Metelics, Inc. reserves the right to make changes to any products and services herein at any time without notice. Consult Aeroflex or an authorized sales representative to verify that the information in this data sheet is current before using this product. Aeroflex does not assume any responsibility or liability arising out of the application or use of any product or service described herein, except as expressly agreed to in writing by Aeroflex; nor does the purchase, lease, or use of a product or service from Aeroflex convey a license under any patent rights, copyrights, trademark rights, or any other of the intellectual rights of Aeroflex or of third parties. Copyright 2003 Aeroflex / Metelics. All rights reserved.



Our passion for performance is defined by three attributes represented by these three icons: solution-minded, performance-driven and customer-focused.