

MH203A

High Linearity Cellular-Band MMIC Mixer

The Communications Edge™

Product Information

Product Features

- +34 dBm Input IP3
- 7.3 dB Conversion Loss
- RF: 800 – 960 MHz
- LO: 1000 – 1310 MHz
- IF: 70 – 350 MHz
- +17 dBm Drive Level
- Lead-free / RoHS-compliant / Green SOIC-8 package
- No External Bias Required

Applications

- 2.5G and 3G GSM/CDMA/wCDMA Mobile Infrastructure

Product Description

The MH203A is a passive GaAs MESFET mixer that provides high dynamic range performance in a low-cost lead-free/green/RoHS-compliant SOIC-8 package. WJ's MH203A uses patented techniques to realize +34 dBm Input IP3 at an LO drive level of +17 dBm and can be used for upconverting or downconverting high-side LO applications. This single monolithic integrated circuit does not require any external baluns or bias elements.

Typical applications include frequency up/down conversion, modulation and demodulation for receivers and transmitters used in 2.5G and 3G GSM/CDMA/wCDMA mobile infrastructure in the cellular frequency band.

Functional Diagram

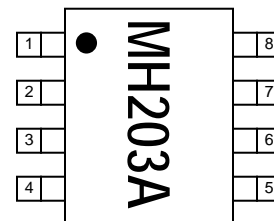

Function	Pin No.
LO	2
IF & RF*	7
GND	1, 3, 4, 6, 8
N/C or GND	5

* External components (inductors & capacitors) are required to diplex the signal

Specifications

Parameters	Units	Min	Typ	Max	Comments
RF Frequency Range	MHz		800 – 960		
LO Frequency Range	MHz		1000 – 1310		
IF Frequency Range	MHz		70 – 350		
SSB Conversion Loss	dB		7.3	8.5	See note 1
Noise Figure	dB		7.8	9.0	See note 2
Input IP3	dBm	+28	+31.5		RF=900-960MHz, IF>300MHz, See note 3
Input IP3	dBm	+30	+34		All other RF/IF combinations, See notes 1 and 3
Input P1dB	dBm		+17.5		
2*LO – RF Isolation	dB		35		Referenced to the LO level at the RF port
LO – RF Isolation	dB	25	30		
LO – IF Isolation	dB	50	60		
RF – IF Isolation	dB		25		
Return Loss: RF Port	dB	10	20		See note 4
Return Loss: IF Port	dB	10	23		See note 4
Return Loss: LO Port	dB	10	15		LO=1064-1089MHz, See note 5
LO Drive Level	dBm		+17		

1. Test conditions unless otherwise noted: RF / IF = 803 / 200, 963 / 200, and 963 / 350 MHz with a high-side LO at +17 dBm in a downconverting application at 25 °C.

The diplexer shown on the application circuit is used in the test fixture.

2. Assumes LO injection noise is filtered at the thermal noise floor, -174 dBm/Hz, at the RF, IF, and Image frequencies.

3. IIP3 is measured with Af = 1 MHz with RFin = 0 dBm / tone.

4. The return loss is measured after the diplexer which splits the RF and IF signals from the mixer.

5. The minimum LO port return loss is 9 dB for LO=1000-1064MHz and LO=1089-1310MHz.

Absolute Maximum Rating

Parameter	Rating
Operating Case Temperature	-40 to +85 °C
Storage Temperature	-65 to +100 °C
LO Power	+21 dBm
Input IF / RF Power	+20 dBm

Operation of this device above any of these parameters may cause permanent damage.

Ordering Information

Part No.	Description
MH203A-G	High Dynamic Range Cellular-band MMIC Mixer (lead-free/green/RoHS-compliant SOIC-8 package)
MH203A-PCB	Fully-Assembled Mixer Application Board

Specifications and information are subject to change without notice



MH203A

High Linearity Cellular-Band MMIC Mixer

The Communications Edge™

Product Information

Typical Upconversion Performance Plots Performance using the circuitry on the MH203A-PCB Evaluation Board

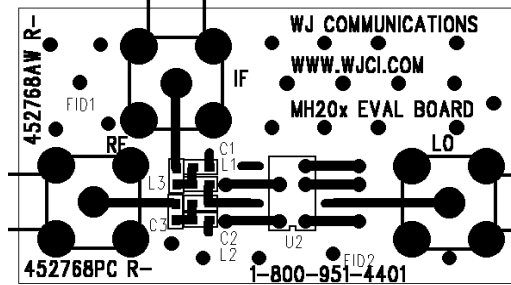
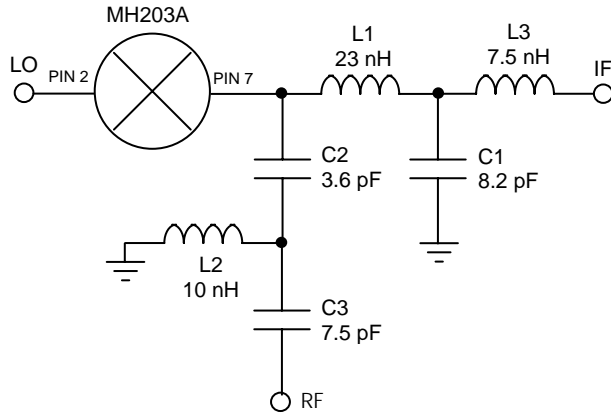

Circuit Board Material: .014" FR-4, 4 layers, .062" total thickness
 All passive components are 0402 size.
 All other pins on mixer are grounded.

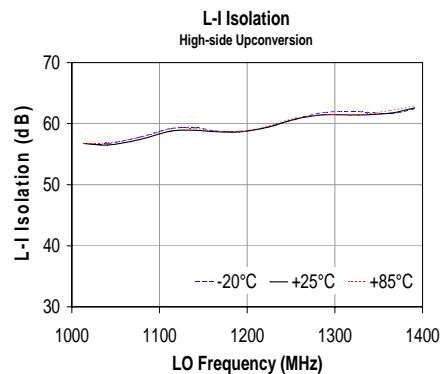
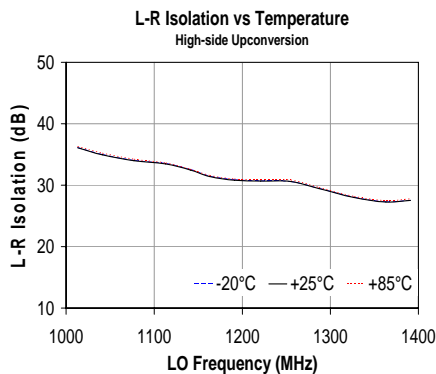
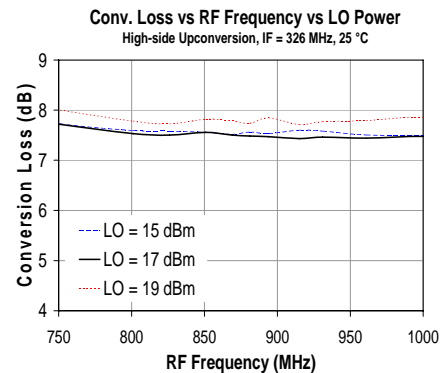
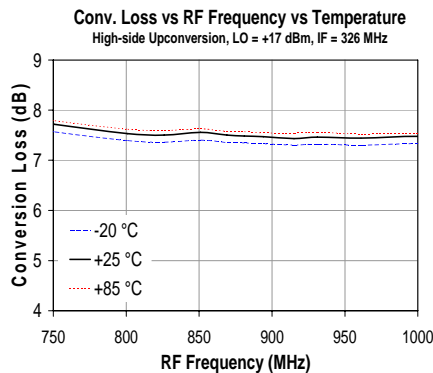
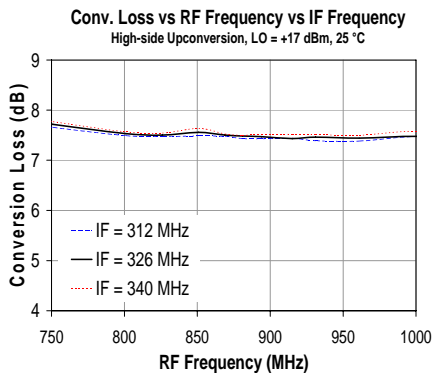
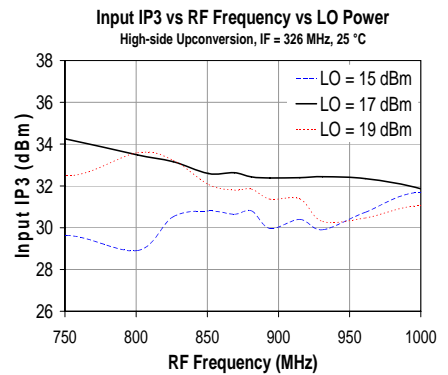
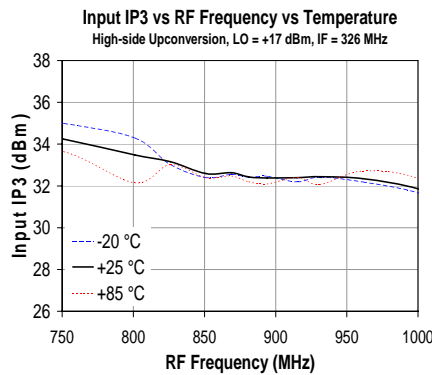
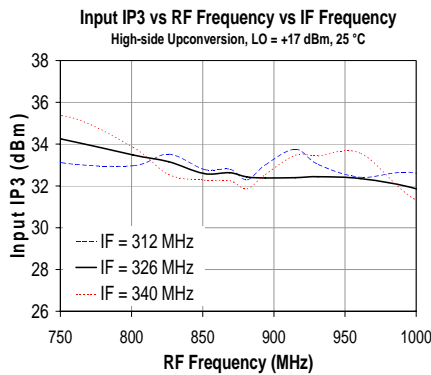

Specifications and information are subject to change without notice



Typical Downconversion Performance Plots Performance using the circuitry on the MH203A-PCB Evaluation Board

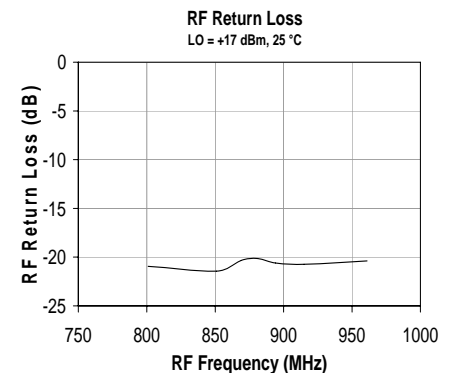
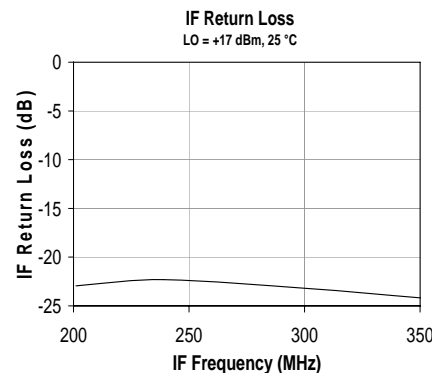
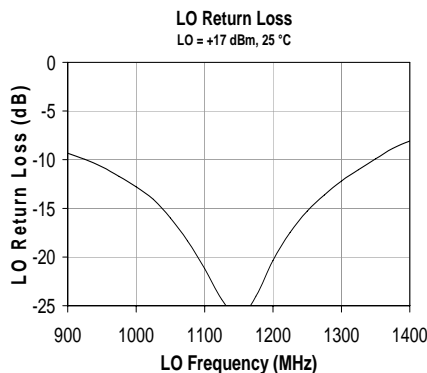
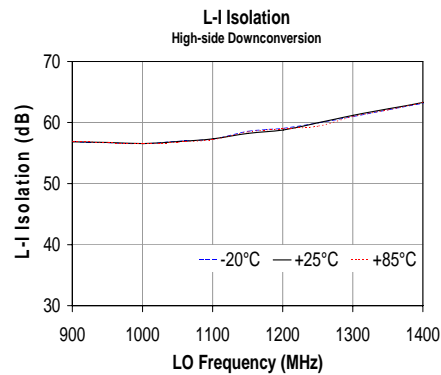
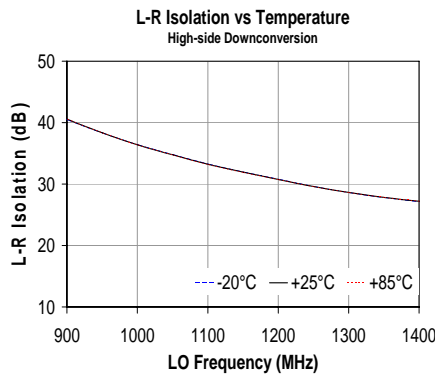
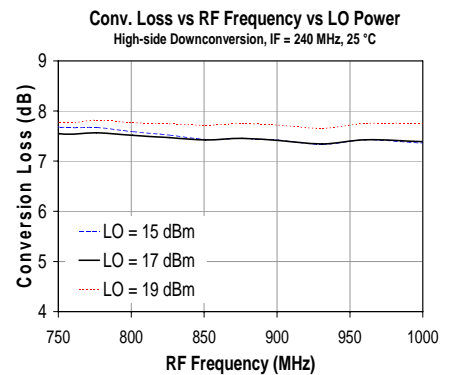
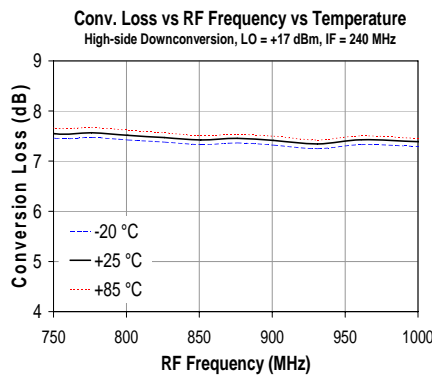
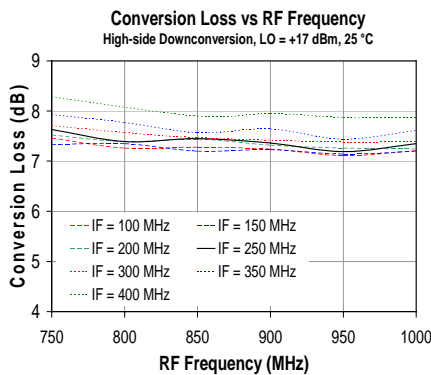
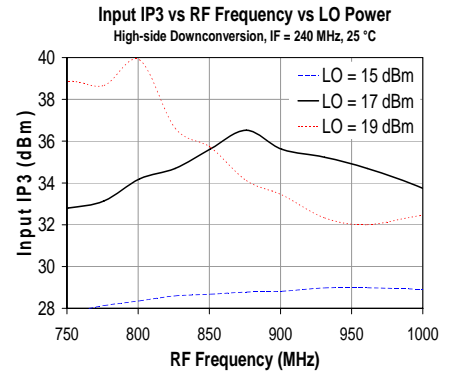
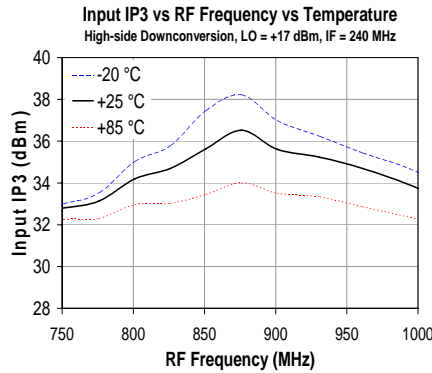
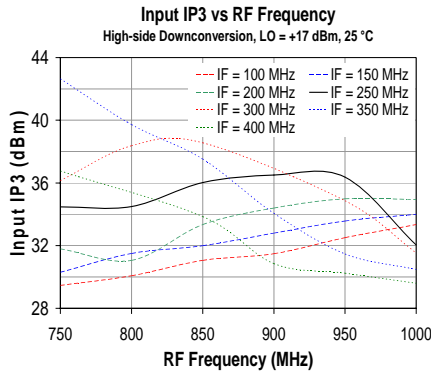

MH203A-G (Lead-Free/Green SOIC-8 Package) Mechanical Information

This package is lead-free/green/RoHS-compliant. The plating material on the leads is NiPdAu. It is compatible with both lead-free (maximum 260 °C reflow temperature) and lead (maximum 245 °C reflow temperature) soldering processes.

Outline Drawing

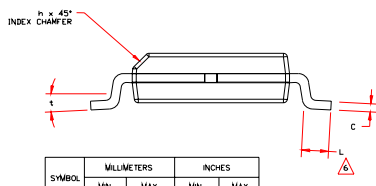
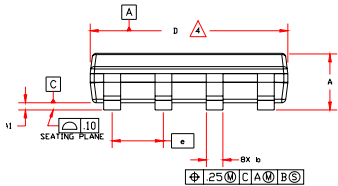
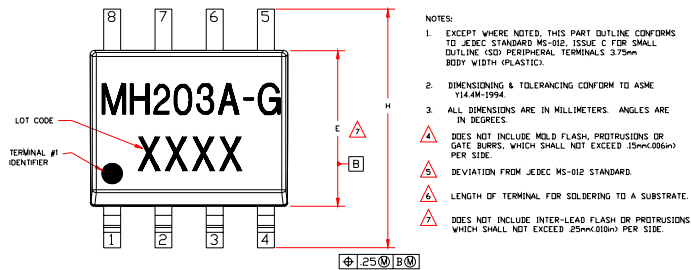

SYMBOL	MILLIMETERS		INCHES	
	MIN.	MAX.	MIN.	MAX.
A	1.30	1.40	.051	.055
At	.10	.25	.004	.010
b		.41		.016
C		.20		.008
D	4.80	5.00	.189	.197
E	3.80	4.00	.150	.157
e	1.27 BSC		.050 BSC	
H	5.80	6.20	.228	.244
h	.25	.50	.01	.02
L	.40	1.27	.016	.050
t	0	8*	0	8*

Product Marking

The component will be marked with an "MH203A-G" designator with an alphanumeric lot code on the top surface of the package. The obsolete tin-lead package is marked with an "M203A" designator with an alpha numeric lot code.

Tape and reel specifications for this part are located on the website in the "Application Notes" section.

ESD / MSL Information



Caution! ESD sensitive device.

ESD Rating: Class 1B

Value: Passes ≥ 500V to <1000 V

Test: Human Body Model (HBM)

Standard: JEDEC Standard JESD22-A114

ESD Rating: Class III

Value: Passes ≥ 500 V to <1000 V

Test: Charged Device Model (CDM)

Standard: JEDEC Standard JESD22-C101

MSL Rating: Level 2 at +260 °C convection reflow

Standard: JEDEC Standard J-STD-020

Land Pattern / Mounting Configuration

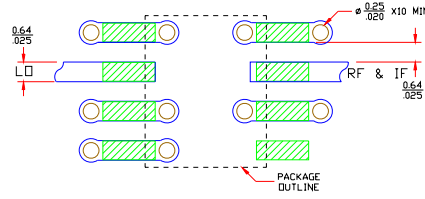
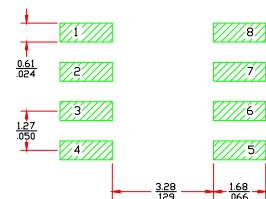

Notes: 1. Ground vias are critical for RF grounding considerations.
2. A minimum of 10 ground vias are required for 14 mil and 28 mil FR4 board.
3. Trace width depends on PC board.

Functional Pin Layout

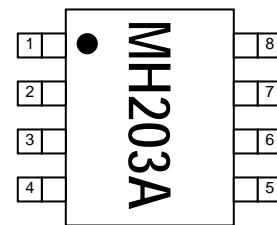

Pin	Function
1	Ground
2	LO Port
3	Ground
4	Ground
5	No Connect / Ground
6	Ground
7	RF / IF Port*
8	Ground

* External components (inductors & capacitors) are required to duplex the signal