

Product Features

- +27 dBm Input IP3
- RF 1800 – 2000 MHz
- IF 200 – 300 MHz
- Low-side LO configuration
- +13 dBm LO Drive Level
- High L-I & L-R Isolation (>30 dB)
- Lead-free/green/RoHS-compliant 6-pin 3x3 mm DFN package
- No External Bias Required

Applications

- 2.5G/3G GSM/CDMA/WCDMA

Product Description

The MH302 is a passive Quad-MOSFET mixer that provides high dynamic range performance in a low cost 3x3 mm 6-pin DFN (Dual Flat No-Lead) lead-free/green/RoHS-compliant package.

WJ's MH302 uses patented techniques to realize +27 dBm Input IP3 at an LO drive level of +13 dBm when used in a simple application circuit with a low-side LO configuration. The LO can also be driven with higher power levels up +20 dBm to achieve higher IP3 performance. This mixer integrates internal circuitry to provide single-ended interfaces for the RF & LO ports.

Typical applications include frequency up/down conversion, modulation and demodulation for receivers and transmitters used in 3G UMTS, PCS, and DCS1800 mobile infrastructure.

Functional Diagram

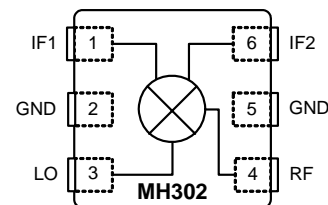

| Function | Pin No. |
|-----------------------|---------|
| IF Differential Input | 1 |
| LO port | 3 |
| RF port | 4 |
| IF differential Input | 6 |
| Ground | 2, 5 |

Specifications

| Parameters | Units | Minimum | Typical | Maximum | Comments |
|------------------------------|-------|---------|---------|---------|--------------------------|
| RF Frequency Range | MHz | 1800 | | 2000 | |
| LO Frequency Range | MHz | 1540 | | 1740 | |
| IF Frequency Range | MHz | 200 | 260 | 300 | See note 2 |
| SSB Conversion Loss | dB | | 7.5 | 8.0 | See note 3 |
| Input IP3 | dBm | +23 | +25 | | RF = 1.8 GHz, See note 4 |
| Input IP3 | dBm | +26 | +27 | | RF = 1.9 GHz, See note 4 |
| Input IP3 | dBm | +23 | +25 | | RF = 2.0 GHz, See note 4 |
| Input 1 dB Compression Point | dBm | +16 | +18 | | See note 5 |
| Noise Figure | dB | | 8 | | |
| LO Input Drive Level | dBm | | +13 | | |
| LO-RF Isolation | dB | 28 | 32 | | |
| LO-IF Isolation | dB | 29 | 35 | | |
| Return Loss: RF Port | dB | | 15 | | |
| Return Loss: LO Port | dB | | 10 | | |
| Return Loss: IF Port | dB | | 15 | | |

- Data was taken using an application board in a 50 Ω system, with a low side LO at +13 dBm in a downconverting application at 25 $^{\circ}$ C with an IF frequency = 260 MHz.
- An IF frequency of 260 MHz is a nominal frequency. The IF frequency can be specified by the user within the constraints of the specified minimum and maximum RF & LO frequency range.
- The conversion loss includes the loss of an IF transformer (M/A COM ETK4-2T, nominal loss 0.7 dB at 260 MHz).
- Input IP3 is measured using two tones with an input power of +3 dBm / tone separated by 1 MHz.
- Although the input P1dB level is much higher, the continuous RF input power should not exceed +12 dBm. Operation above +12 dBm may cause permanent damage.

Absolute Maximum Ratings

| Parameters | Rating |
|----------------------------|--------------------------|
| Operating Case Temperature | -40 to +85 $^{\circ}$ C |
| Storage Temperature | -40 to +125 $^{\circ}$ C |
| LO Input Power | +20 dBm |
| RF Input Power | +12 dBm |

Operation of this device above any of these parameters may cause permanent damage.

Ordering Information

| Part No. | Description |
|-----------|--|
| MH302-G | PCS/UMTS-band Quad-FET Mixer (lead-free/green/RoHS-compliant Package) |
| MH302-PCB | Fully-Assembled MH302 Application Board |

Specifications and information are subject to change without notice



Typical Performance Charts

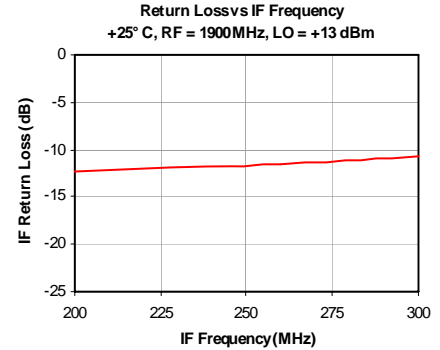
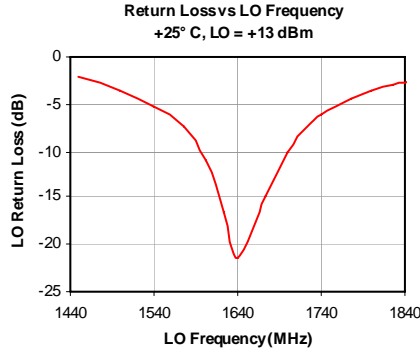
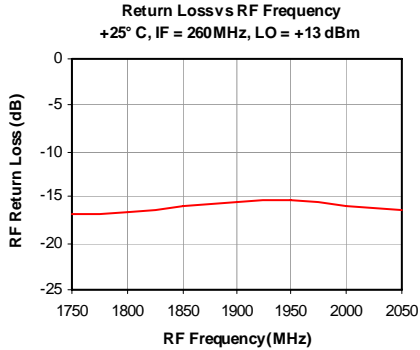
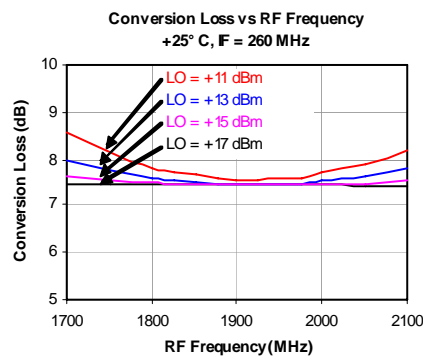
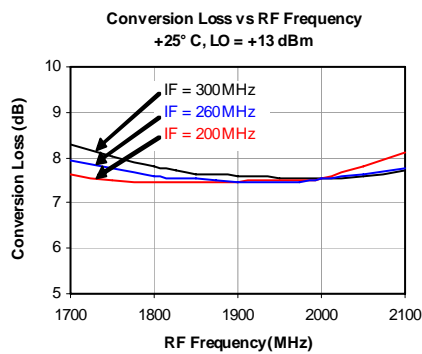
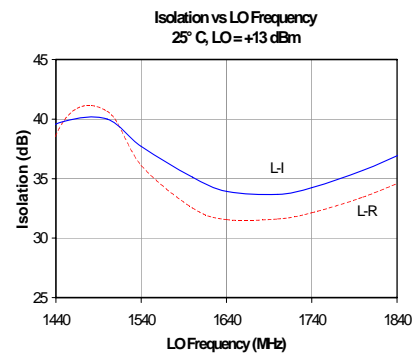
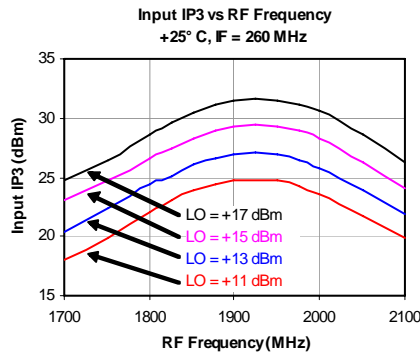
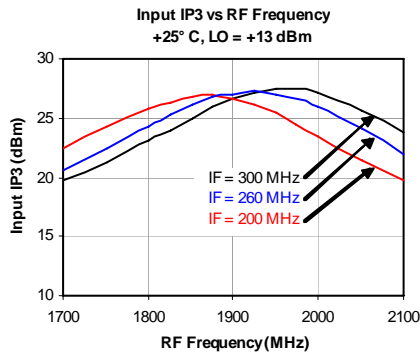

Application Circuit

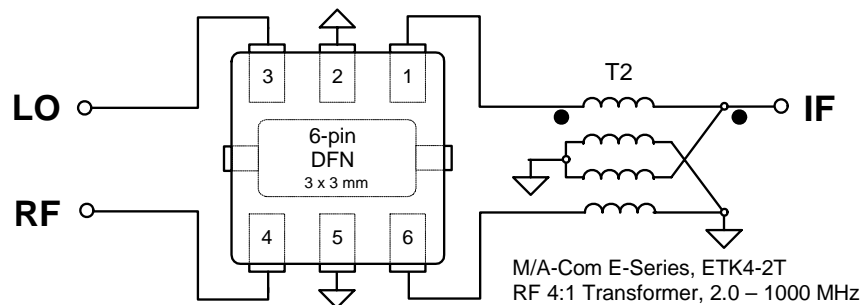



MH302-G Mechanical Information

This package is lead-free/Green/RoHS-compliant. The plating material on the leads is annealed matte tin over copper. It is compatible with both lead-free (maximum 260 °C reflow temperature) and leaded (maximum 245 °C reflow temperature) soldering processes.

Package Information

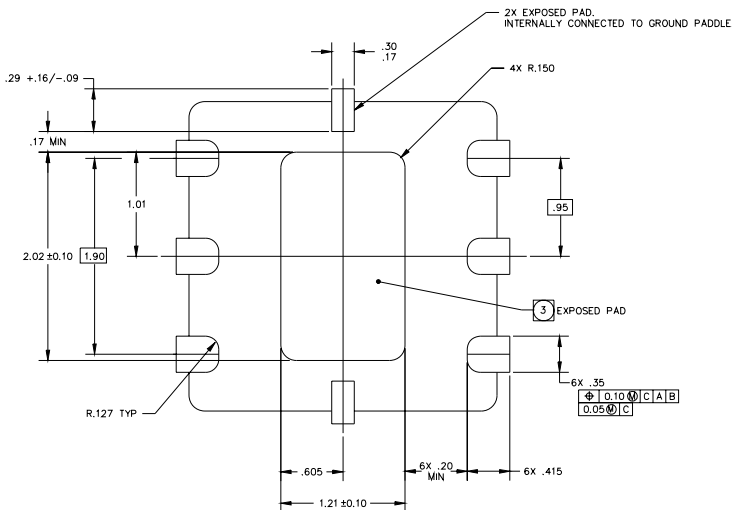
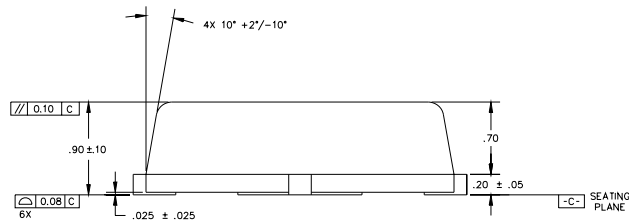
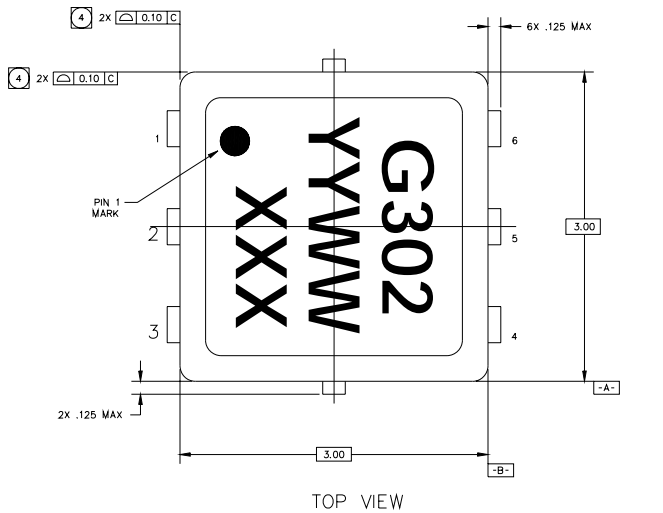

- NOTES:
1. DIMENSIONING AND TOLERANCING CONFORM TO ASME Y14.5M-1994
 2. DIMENSIONS ARE EXPRESSED IN MILLIMETERS, ANGLES ARE EXPRESSED IN DEGREES.
 3. COPLANARITY APPLIES TO THE EXPOSED HEAT SINK SLUG AS WELL AS THE TERMINALS.
 4. PROFILE TOLERANCE WILL BE APPLICABLE ONLY TO THE PLASTIC BODY, AND NOT THE METALIZED FEATURES (SUCH AS THE TERMINAL TIPS AND TIE BARS). METALIZED FEATURES MAY PROTRUDE A MAXIMUM OF .125 FROM THE PLASTIC BODY PROFILE.
 5. PACKAGE CONFORMS TO JEDEC MO-229 VARIATION VEEA.

Product Marking

The component will be laser marked with a model number "G302" designator exactly as shown followed by an assembly date code in location shown by "YYWW". A laser marked lot code will be in the location shown by "XXX" and is unique for every assembly lot. The obsolete tin-lead package is marked with an "M302" designator.

Tape and reel specifications for this part are located on the website in the "Application Notes" section.

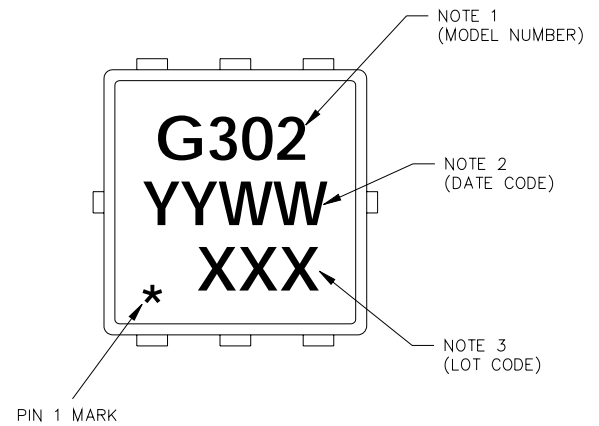

Functional Schematic Diagram

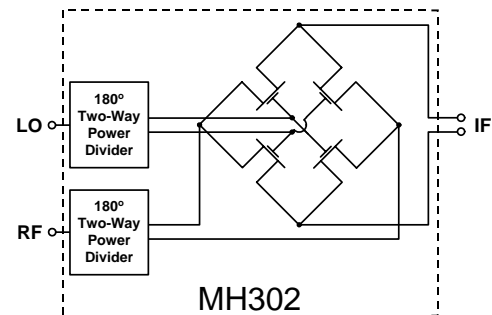

ESD / MSL Information

ESD Rating: Class 1B
 Value: Passes at 500 V
 Test: Human Body Model (HBM)
 Standard: JEDEC Standard JESD22-A114

MSL Rating: Level 1 at 260 °C convection reflow
 Standard: JEDEC Standard J-STD-020