

MHP-TAT18 Series Breaker



Description

The new Metal Hybrid PPTC device, MHP-TAT18, offers a 9VDC rating and a higher current rating than typical MHP-TAM devices. MHP-TAT18 helps to meet the battery safety requirements of higher-capacity Lithium (Ion) Polymer and prismatic batteries found in most mobile devices such as laptop PC's, tablets, and smart phones. MHP technology connects a bimetal protector in parallel with a Polymeric Positive Temperature Coefficient (PPTC) device. The PPTC device to act as a heater and to help keep the bimetal latched until the fault is removed. The resulting MHP-TAT18 series helps to provide resettable overtemperature protection.

Circuit Diagram

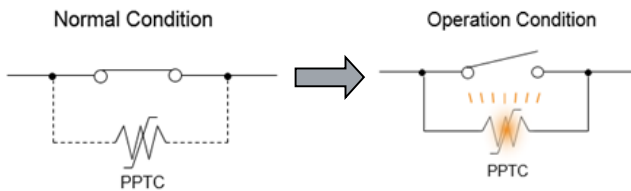

Features

- High current capacity with low resistance
- Overtemperature and overcurrent protection
- Multiple activation temperature ratings (72°C, 77°C, 82°C, 85°C, 90°C)
- Compact size (L: 5.8mm x W: 3.80mm x H: 1.15mm) allows for ultra-thin battery pack designs
- Evaluated to UL 60730-1 and UL 60730-2-9, CAN/CSA E60730-1, CAN/CSA E730-2-9 and IEC 60730-1 and IEC 60730-2-9.

Agency Approvals

Agency	Agency File Number
	E349829
	DK-74156-M1-UL

Applications

Battery cell protection for high-capacity Lithium Polymer and Prismatic cells used in:

- Gaming PCs
- Notebook PCs
- Ultra-book
- Tablets
- Battery-powered portable devices

Typical Electrical Ratings

Specification	MHP-TAT18-9-72	MHP-TAT18-9-77	MHP-TAT18-9-82	MHP-TAT18-9-85	MHP-TAT18-9-90
Operation Temperature	72°C+/-5°C	77°C+/-5°C	82°C+/-5°C	85°C+/-5°C	90°C+/-5°C
Reset Temperature	≥40°C	≥40°C	≥40°C	≥40°C	≥40°C
Hold Current	18A@25°C				
Contact Rating	DC 9V/30A, 6000 Cycles				
Maximum Breaking Current	DC 5V/80A, 100 Cycles				
Maximum Open Voltage	DC 28V/30A, 100 Cycles				
Minimum Hold Voltage	3V				
Maximum Leakage Current	200mA@25°C				
Resistance	2.5 milliohms Max.				

Precautions for Electrical Characteristics:

- Device electrical characteristics may change depending on installation conditions. Users should independently evaluate the suitability of and test each product in their own application.
- If any terminal or lead extensions are added to the device, especially in the case of high current discharging, the device performance may be negatively impacted due to variations in welding methods or materials. Please avoid designs that might cause heat to be generated around the joints of the lead extensions or on the extended terminals.
- SMT solder reflow, wave-soldering and manual soldering irons are not permitted.

Dimensions

A		B		C		D		E	
Min	Max	Min	Max	Min	Max	Min	Max	Min	Max
10.9mm	11.5mm	1.05mm	1.15mm	3.75mm	3.85mm	2.6mm	2.8mm	2.6mm	2.8mm

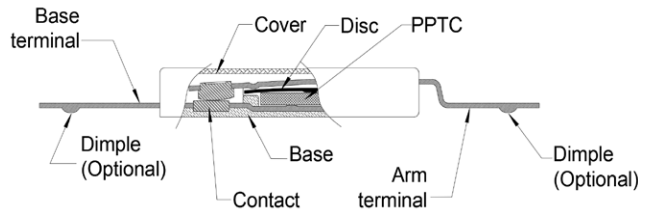
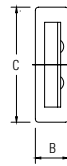
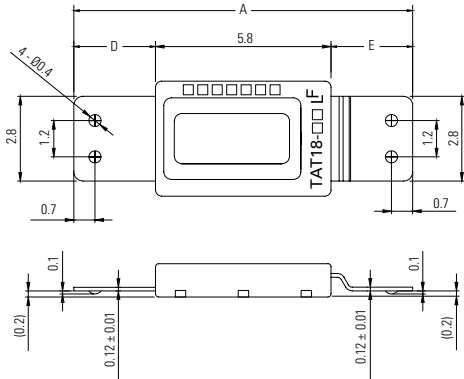

Notes:

Unspecified dimensions, tolerance should be ± 0.1 mm
Dimensions in brackets are for reference

Current Vs. Temperature Curves

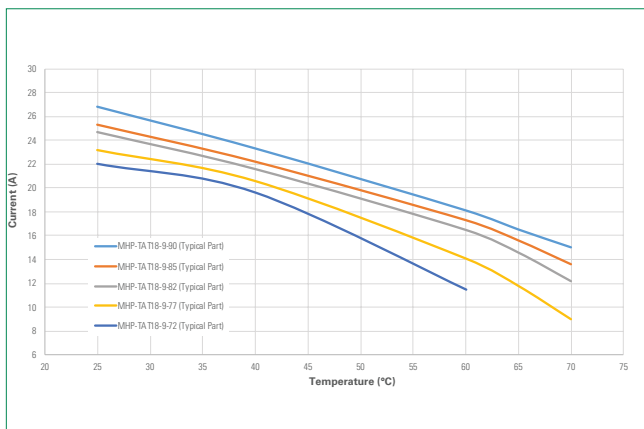

The current versus temperature curve was derived from placing test samples in an oven at 25°C, 40°C, 60°C, 65°C, and 70°C, increasing current flow through the sample at a rate of 0.1A/minute and recording the current value when the sample trips.

Part Marking System

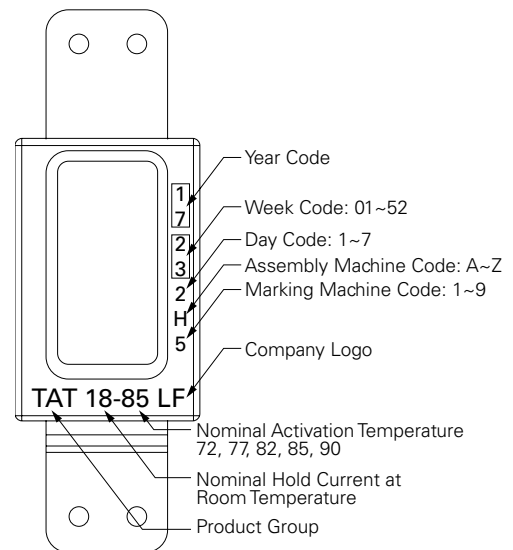

Part Ordering Number System

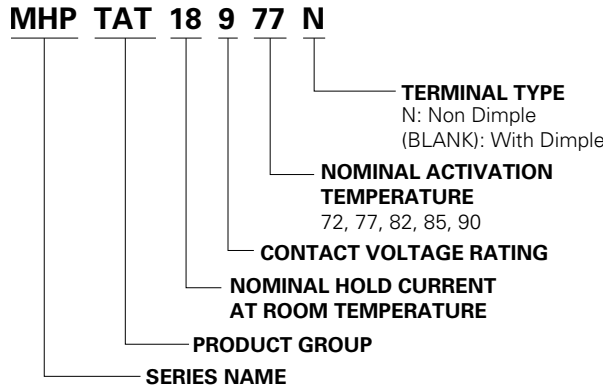

Application Environment

The device is intended to be used for applications which are common for general electronic devices. Usage in any of the special environments or conditions as listed below may adversely impact the device performance and therefore users should carefully consider conditions of use of the end product and the potential impact on reliability or performance when incorporating this device into any design to carefully examine the actual performance and reliability of the device.

- Environment where the devices are exposed to water, oil, chemical solutions, and/or organic solvents.
- Installation in an area close to a heat source or adjacent to or near flammable objects such as plastic wires.
- Environment in which the device is constrained by pressure, sealing or resin coating.
- Environment where water condenses on the device.
- Environment with salt air or with corrosive gas such as Cl_2 , H_2S , NH_3 , SO_2 , and NOX .
- Environment with grit and dust and/or under direct sunlight.
- Environment outside of recommended operating temperature.

Packaging

Packaging Option	Quantity	Quantity & Packaging Code
20,000 pcs. Minimum	1000 pcs/bag	1 bag per inner box 20 inner box in 1 outer box

Precautions for Rating

- The power supply voltage must be less than or equal to the rated voltage of the device. Operation above the voltage rating may result in device damage, smoke or flame.
- Designs must be selected in such a manner that the device hold current is higher than the normal current value in the circuit. Selecting device hold current that is too low for the application may interrupt the circuit under normal usage conditions.
- This product should not be used in an application where the maximum short circuit current available exceeds the rated maximum breaking current of the product.
- The devices are intended for protection against damage caused by occasional over current or over temperature fault conditions and should not be used when repeated fault conditions or prolonged trip events are anticipated.
- The devices may not perform as specified if mechanical pressure is added while the device is in the tripped state or exposed to temperature conditions over $100^{\circ}C$ or in temperature conditions under $-30^{\circ}C$.

Handling Precautions

- a.** The device is composed of plastic parts, please do not clamp or dent the housing with a tool as this might cause a resistance increase and product damage.
- b.** When welding product terminals or mounting the breaker on battery (cell), please be careful not to apply excessive bending, twisting or force on the product and terminals. The excessive stress might cause a resistance increase or product damage.

Please refer to following cautions.

- Do not apply more than 10N bend force to product. (Fig. 1)
- Do not apply more than 1.5cN*m twist torque to the product. (Fig. 2)
- Do not apply more than 20N deflection force to product. (Fig. 3)
- Do not apply more than 2N force to the terminals. (Fig. 4)
- Do not apply more than 0.6cN*m twisting torque to the terminals. (Fig. 5)
- Do not bend the terminals more than 45° at the end. (Fig. 6)
- Should not twist terminals more than 20°C with breaker body fixed.

- c.** Product terminals can be welded using direct welding and series welding methods. In either case, please use a suitable Jig so that the device will not be subjected to the stress conditions listed above.
- d.** Pull strength and detach strength of the terminal welds are per user requirements. However, if the welding is controlled by resistance, the measurement should be made as close as possible to the weld point by a "4-point clip method" using milliohm meter to ensure accuracy.
- e.** Please avoid putting the stress on the device, as listed above, when a jig, fitting or additional welding process is used. Please re-confirm the resistance value whenever a new process is added.

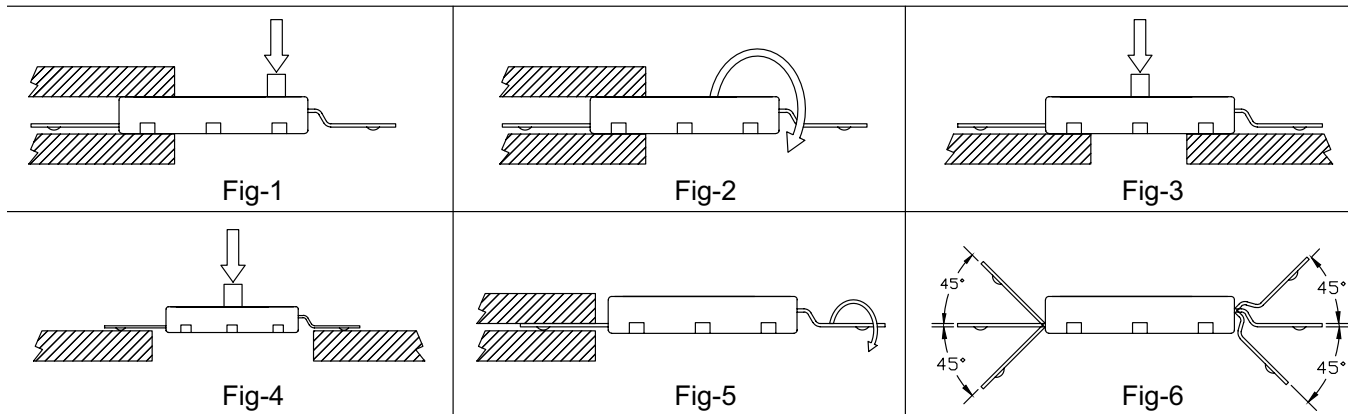

Disclaimer Notice - Information furnished is believed to be accurate and reliable. However, users should independently evaluate the suitability of and test each product selected for their own applications. Littelfuse products are not designed for, and may not be used in, all applications. Read complete Disclaimer Notice at www.littelfuse.com/disclaimer-electronics.