

The RF Line
PCS Band
RF Linear LDMOS Amplifier

Designed for Class AB amplifier applications in 50 ohm systems operating in the PCS frequency band. A silicon FET design provides outstanding linearity and gain. In addition, the excellent group delay and phase linearity characteristics are ideal for digital modulation systems, such as TDMA and CDMA.

- Typical CDMA Performance: 1960 MHz, 28 Volts IS-95 CDMA Pilot, Sync, Paging, Traffic Codes 8 Through 13
- Adjacent Channel Power: -51 dBc @ 30 dBm, 885 kHz Channel Spacing
- Power Gain: 24.5 dB Min (@ f = 1960 MHz)
- Excellent Phase Linearity and Group Delay Characteristics
- 0.2 dB Typical Gain Flatness
- Ideal for Feedforward Base Station Applications

MHPA19010

1930–1990 MHz
10 W, 24.5 dB
RF HIGH POWER LDMOS AMPLIFIER

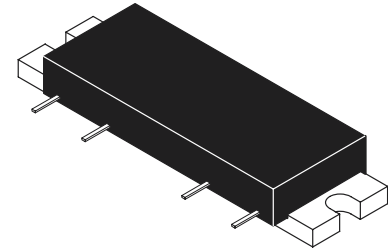

CASE 301AP-02, STYLE 3

MAXIMUM RATINGS ($T_C = 25^\circ\text{C}$ unless otherwise noted)

Rating	Symbol	Value	Unit
DC Supply Voltage	V_{DD}	30	Vdc
RF Input Power (Single Carrier CW)	P_{in}	+20	dBm
Storage Temperature Range	T_{stg}	-40 to +100	$^\circ\text{C}$
Operating Case Temperature Range	T_C	-20 to +100	$^\circ\text{C}$
Quiescent Bias Current	I_{DQ}	750	mA

ELECTRICAL CHARACTERISTICS ($V_{DD} = 28\text{ Vdc}$, $V_{BIAS} \cong 8\text{ V}$ Set for Supply Current of 600 mA, $T_C = 25^\circ\text{C}$, 50 Ω System)

Characteristic	Symbol	Min	Typ	Max	Unit
Supply Current	I_{DD}	—	600	—	mA
Power Gain (f = 1960 MHz)	G_p	24.5	25	—	dB
Gain Flatness (f = 1930–1990 MHz)	G_F	—	0.2	0.5	dB
Power Output @ 1 dB Comp. (f = 1960 MHz)	P_{1dB}	—	41.5	—	dBm
Input VSWR (f = 1930–1990 MHz)	$VSWR_{in}$	—	1.5:1	2:1	
Noise Figure (f = 1960 MHz)	NF	—	8	10	dB
Adjacent Channel Power Rejection @ 30 dBm, 1.23 MHz BW, 885 kHz Channel Spacing	ACPR	—	-58	-51	dBc

TYPICAL CHARACTERISTICS

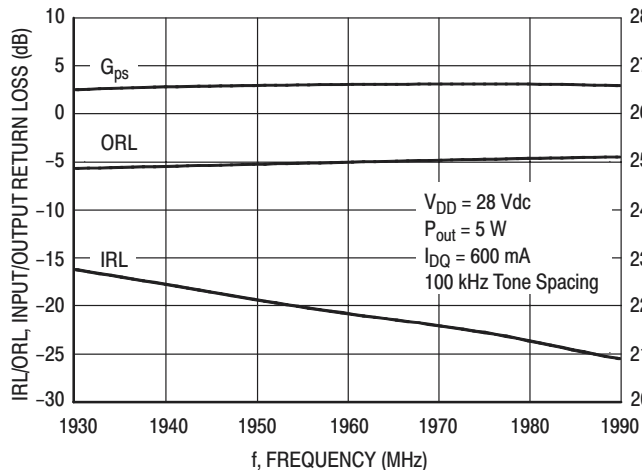

Figure 1. Two-Tone Power Gain, Input Return Loss and Output Return Loss versus Frequency

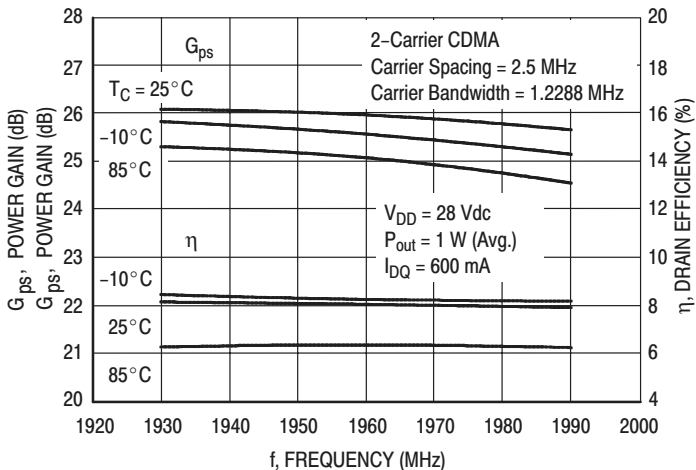

Figure 2. 2-Carrier CDMA Power Gain and Efficiency versus Frequency

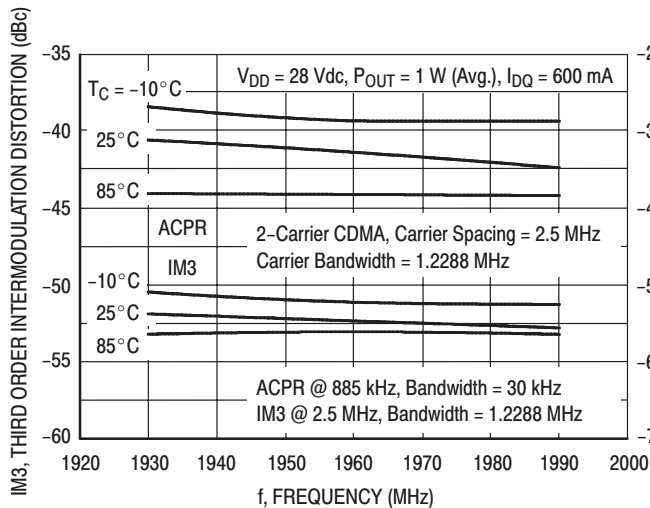

Figure 3. 2-Carrier CDMA IM3 and ACPR versus Frequency

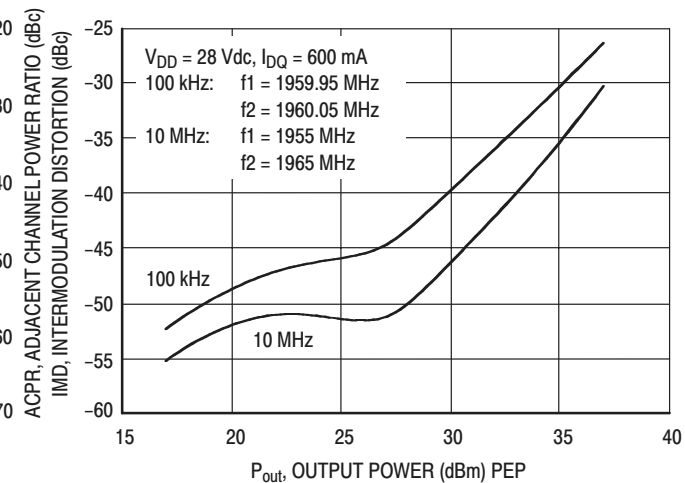

Figure 4. Two-Tone CDMA IMD versus Output Power

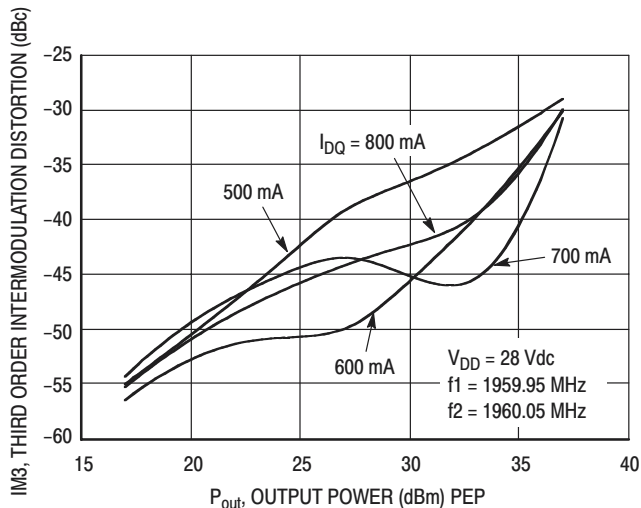

Figure 5. Third Order Intermodulation Distortion versus Output Power

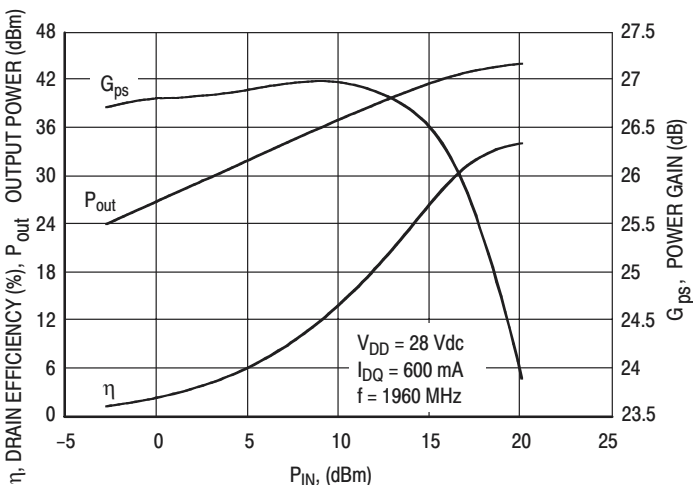

Figure 6. CW Output Power, Efficiency and Gain versus Input Power

Freescale Semiconductor, Inc.

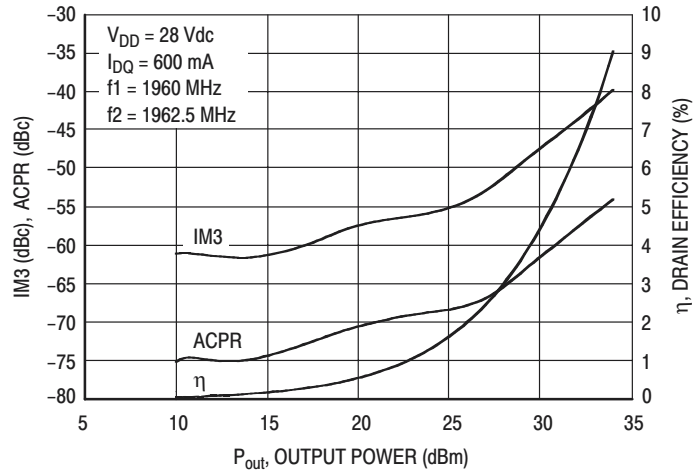
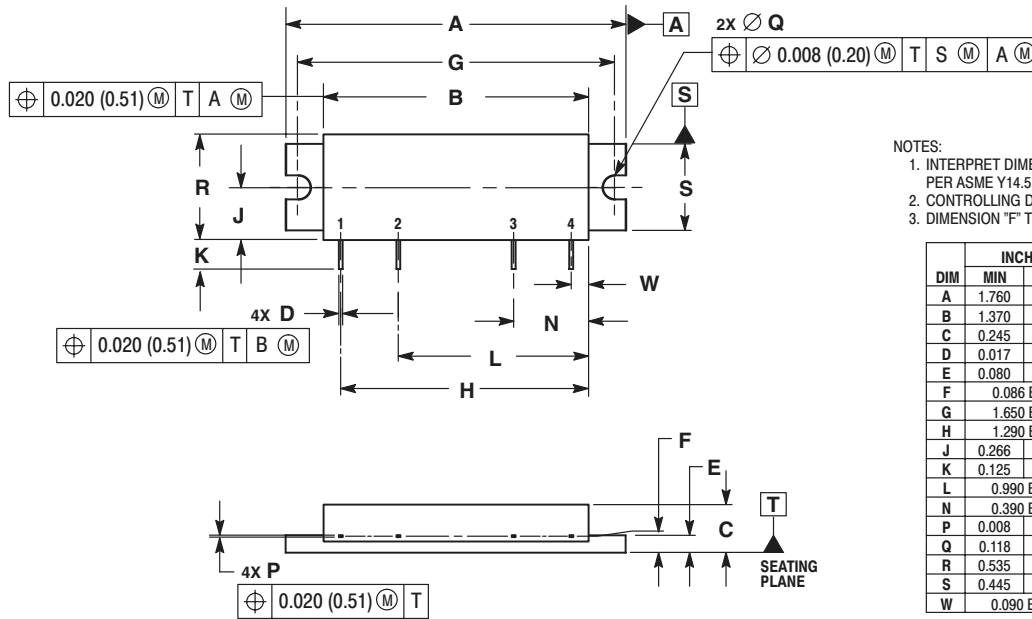

Figure 7. 2–Carrier CDMA ACPR, IM3 and Efficiency versus Output Power

Freescale Semiconductor, Inc.

PACKAGE DIMENSIONS



- NOTES:
1. INTERPRET DIMENSIONS AND TOLERANCES PER ASME Y14.5M, 1994.
 2. CONTROLLING DIMENSION: INCH.
 3. DIMENSION "F" TO CENTER OF LEADS.

DIM	INCHES		MILLIMETERS	
	MIN	MAX	MIN	MAX
A	1.760	1.780	44.70	45.21
B	1.370	1.390	34.80	35.31
C	0.245	0.265	6.22	6.73
D	0.017	0.023	0.43	0.58
E	0.080	0.100	2.03	2.54
F	0.086 BSC		2.18 BSC	
G	1.650 BSC		41.91 BSC	
H	1.290 BSC		32.77 BSC	
J	0.266	0.280	6.76	7.11
K	0.125	0.165	3.18	4.19
L	0.990 BSC		25.15 BSC	
N	0.390 BSC		9.91 BSC	
P	0.008	0.013	0.20	0.33
Q	0.118	0.132	3.00	3.35
R	0.535	0.555	13.59	14.10
S	0.445	0.465	11.30	11.81
W	0.090 BSC		2.29 BSC	

- STYLE 3:
- PIN 1. RF INPUT
 - VBIAS
 - VDD
 - RF OUTPUT
- CASE: GROUND

CASE 301AP-02 ISSUE C

NOTE: V_{DD} (Pin 3) should always be applied before V_{BIAS} (Pin 2).

Motorola reserves the right to make changes without further notice to any products herein. Motorola makes no warranty, representation, or guarantee regarding the suitability of its products for any particular purpose, nor does Motorola assume any liability arising out of the application or use of any product or circuit, and specifically disclaims any and all liability, including without limitation consequential or incidental damages. "Typical" parameters can and do vary in different applications and actual performance may vary over time. All operating parameters, including "Typicals", must be validated for each customer application by customer's technical experts. Motorola does not convey any license under its patent rights nor the rights of others. Motorola products are not designed, intended, or authorized for use as components in systems intended for surgical implant into the body, or other applications intended to support or sustain life, or for any other application in which the failure of the Motorola product could create a situation where personal injury or death may occur. Should Buyer purchase or use Motorola products for any such unintended or unauthorized application, Buyer shall indemnify and hold Motorola and its officers, employees, subsidiaries, affiliates, and distributors harmless against all claims, costs, damages, and expenses, and reasonable attorney fees arising out of, directly or indirectly, any claim of personal injury or death associated with such unintended or unauthorized use, even if such claim alleges that Motorola was negligent regarding the design or manufacture of the part. Motorola and the Stylized M Logo are registered trademarks of Motorola, Inc. Motorola, Inc. is an Equal Opportunity/Affirmative Action Employer.

Motorola and the Stylized M Logo are registered in the US Patent & Trademark Office. All other product or service names are the property of their respective owners.

© Motorola, Inc. 2003.

How to reach us:

USA/EUROPE/Locations Not Listed: Motorola Literature Distribution; P.O. Box 5405, Denver, Colorado 80217. 1-303-675-2140 or 1-800-441-2447

JAPAN: Motorola Japan Ltd.; SPS, Technical Information Center, 3-20-1, Minami-Azabu, Minato-ku, Tokyo 106-8573 Japan. 81-3-3440-3569

ASIA/PACIFIC: Motorola Semiconductors H.K. Ltd.; Silicon Harbour Centre, 2 Dai King Street, Tai Po Industrial Estate, Tai Po, N.T. Hong Kong. 852-26668334

Technical Information Center: 1-800-521-6274

HOME PAGE: <http://www.motorola.com/semiconductors>



MOTOROLA

For More Information On This Product,
Go to: www.freescale.com

MHPA19010/D