

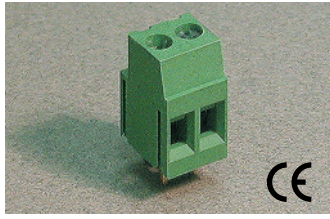

5.08mm Pin Spacing – Fixed PCB Blocks

Pin Spacing: 5.08mm*
 Orientation: Vertical
 Clamp Type: Screw Cage
 Design: Modular



MVSP-25xx

ELECTRICAL

	Current	Voltage	Wire Range
	15A ^①	300V	30-14AWG
	24A	450V	2.5mm ² Stranded 4.0mm ² Solid

INSTALLATION DATA

Screw Size	M3	PCB Hole Size	1.5mm
Torque	0.5Nm (4.5 lbf-in.)	Stripping Lgth.	9.5mm

MATERIAL

Body	Polyamide	Screw	Galvanized Steel
Flammability Class	UL94V-0	Terminal	Tin-Plated Brass
Temperature Limit	105°C UL 125°C IEC	Clamp	Nickel Brass
Color	Green		

No. Poles	Cat. #	Length (mm)	Std. Pk.
2	MVSP-252	10.2	100
3	MVSP-253	15.2	100
4	MVSP-254	20.3	50
5	MVSP-255	25.4	50
6	MVSP-256	30.5	50
7	MVSP-257	35.6	50
8	MVSP-258	40.6	50
9	MVSP-259	45.7	50
10	MVSP-2510	50.8	50
11	MVSP-2511	55.9	50
12	MVSP-2512	61.0	50
13	MVSP-2513	66.0	20
14	MVSP-2514	71.1	20
15	MVSP-2515	76.2	20
16	MVSP-2516	81.3	20
17	MVSP-2517	86.4	20
18	MVSP-2518	91.4	20
19	MVSP-2519	96.5	20
20	MVSP-2520	101.6	20
21	MVSP-2521	106.7	20
22	MVSP-2522	111.8	20
23	MVSP-2523	116.8	20
24	MVSP-2524	121.9	20

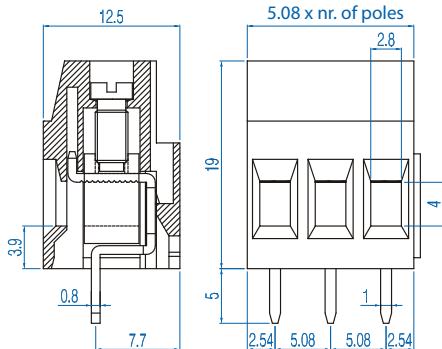

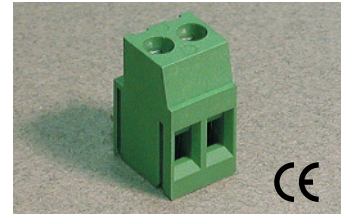

① 18A Factory Wiring - UL * Also available in 10.16mm pin spacing.

Pin Spacing: 5.08mm*
 Orientation: Horizontal
 Clamp Type: Screw Cage
 Design: Modular



MHSP-25xx

ELECTRICAL

	Current	Voltage	Wire Range
	15A ^②	300V	30-14AWG
	24A	450V	2.5mm ² Stranded 4.0mm ² Solid

INSTALLATION DATA

Screw Size	M3	PCB Hole Size	1.5mm
Torque	0.5Nm (4.5 lbf-in.)	Stripping Lgth.	9.5mm

MATERIAL

Body	Polyamide	Screw	Galvanized Steel
Flammability Class	UL94V-0	Terminal	Tin-Plated Brass
Temperature Limit	105°C UL 125°C IEC	Clamp	Nickel Brass
Color	Green		

No. Poles	Cat. #	Length (mm)	Std. Pk.
2	MHSP-252	10.2	100
3	MHSP-253	15.2	100
4	MHSP-254	20.3	50
5	MHSP-255	25.4	50
6	MHSP-256	30.5	50
7	MHSP-257	35.6	50
8	MHSP-258	40.6	50
9	MHSP-259	45.7	50
10	MHSP-2510	50.8	50
11	MHSP-2511	55.9	50
12	MHSP-2512	61.0	50
13	MHSP-2513	66.0	20
14	MHSP-2514	71.1	20
15	MHSP-2515	76.2	20
16	MHSP-2516	81.3	20
17	MHSP-2517	86.4	20
18	MHSP-2518	91.4	20
19	MHSP-2519	96.5	20
20	MHSP-2520	101.6	20
21	MHSP-2521	106.7	20
22	MHSP-2522	111.8	20
23	MHSP-2523	116.8	20
24	MHSP-2524	121.9	20

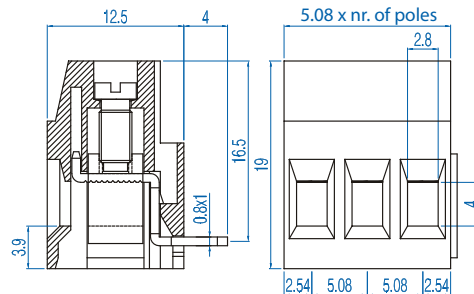

② 18A Factory Wiring - UL * Also available in 10.16mm pin spacing.