

RF LDMOS Wideband Integrated Power Amplifier

The MHVIC2115NR2 wideband integrated circuit is designed for base station applications. It uses Freescale's newest High Voltage (26 to 28 Volts) LDMOS IC technology and integrates a multi-stage structure. Its wideband On-Chip matching design makes it usable from 1600 to 2600 MHz. The linearity performances cover W-CDMA modulation formats.

Final Application

- Typical W-CDMA Performance: -45 dBc ACPR, 2110-2170 MHz, $V_{DD} = 27$ Volts, $I_{DQ1} = 56$ mA, $I_{DQ2} = 61$ mA, $I_{DQ3} = 117$ mA, $P_{out} = 34$ dBm, 3GPP Test Model 1, Measured in 1.0 MHz BW @ 4 MHz offset, 64 DTCH
 Power Gain — 30 dB
 PAE = 16%

Driver Application

- Typical W-CDMA Performance: -53 dBc ACPR, 2110-2170 MHz, $V_{DD} = 26$ Volts, $I_{DQ1} = 96$ mA, $I_{DQ2} = 204$ mA, $I_{DQ3} = 111$ mA, $P_{out} = 23$ dBm, 3GPP Test Model 1, Measured in 3.84 MHz BW @ 5 MHz offset, 64 DTCH
 Power Gain — 34 dB
- Gain Flatness = 0.3 dB from 2110-2170 MHz
- P1dB = 15 Watts, Gain Flatness = 0.2 dB from 2110-2170 MHz
- Capable of Handling 3:1 VSWR, @ 26 Vdc, 2140 MHz, 15 Watts CW Output Power

Features

- Characterized with Series Equivalent Large-Signal Impedance Parameters
- On-Chip Matching (50 Ohm Input, DC Blocked, >5 Ohm Output)
- Integrated Temperature Compensation with Enable/Disable Function
- Integrated ESD Protection
- RoHS Compliant
- In Tape and Reel. R2 Suffix = 1,500 Units per 16 mm, 13 inch Reel.

Table 1. Maximum Ratings

Rating	Symbol	Value	Unit
Drain-Source Voltage	V_{DSS}	-0.5, +65	Vdc
Gate-Source Voltage	V_{GS}	-0.5, +15	Vdc
Storage Temperature Range	T_{stg}	- 65 to +150	°C
Operating Junction Temperature	T_J	150	°C

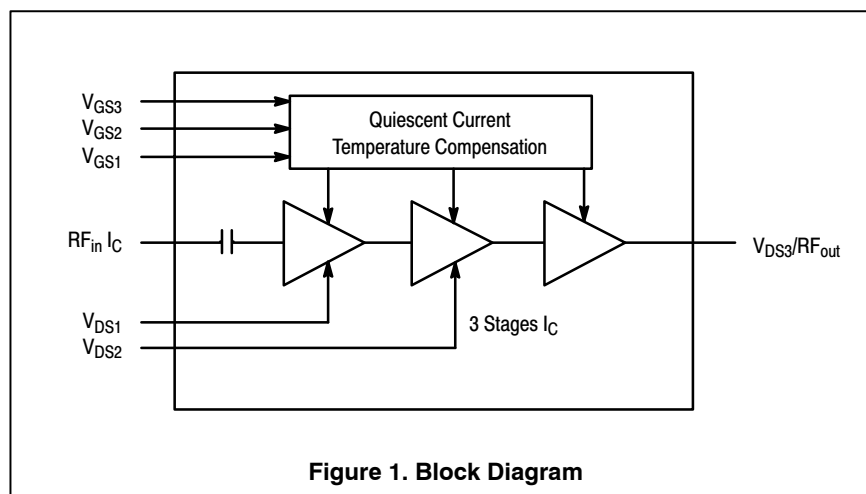
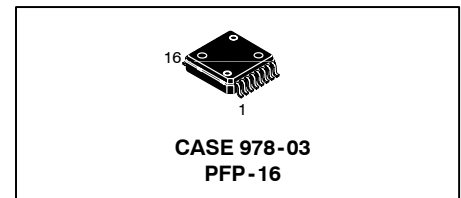

Figure 1. Block Diagram

MHVIC2115NR2

2170 MHz, 26 V, 23/34 dBm
W-CDMA
RF LDMOS WIDEBAND
INTEGRATED POWER AMPLIFIER



CASE 978-03
FFP-16

Figure 2. Pin Connections

Table 2. Thermal Characteristics

Characteristic	Symbol	Value	Unit
Thermal Resistance, Junction to Case	$R_{\theta JC}$		$^{\circ}\text{C}/\text{W}$
Driver Application ($P_{\text{out}} = +0.2 \text{ W CW}$)	Stage 1, 26 Vdc, $I_{DQ} = 96 \text{ mA}$ Stage 2, 26 Vdc, $I_{DQ} = 204 \text{ mA}$ Stage 3, 26 Vdc, $I_{DQ} = 111 \text{ mA}$	3.5	
Output Application ($P_{\text{out}} = +2.5 \text{ W CW}$)	Stage 1, 27 Vdc, $I_{DQ} = 56 \text{ mA}$ Stage 2, 27 Vdc, $I_{DQ} = 61 \text{ mA}$ Stage 3, 27 Vdc, $I_{DQ} = 117 \text{ mA}$	2.7	

Table 3. ESD Protection Characteristics

Test Conditions	Class
Human Body Model	1 (Minimum)
Machine Model	M1 (Minimum)
Charge Device Model	C2 (Minimum)

Table 4. Moisture Sensitivity Level

Test Methodology	Rating	Package Peak Temperature	Unit
Per JESD 22-A113, IPC/JEDEC J-STD-020	3	260	$^{\circ}\text{C}$

Table 5. Electrical Characteristics ($T_C = 25^{\circ}\text{C}$ unless otherwise noted)

Characteristic	Symbol	Min	Typ	Max	Unit
----------------	--------	-----	-----	-----	------

W-CDMA Characteristics (In Freescale Test Fixture, 50 ohm system) $V_{DD} = 26 \text{ Vdc}$, $I_{DQ1} = 96 \text{ mA}$, $I_{DQ2} = 204 \text{ mA}$, $I_{DQ3} = 111 \text{ mA}$, $P_{\text{out}} = 23 \text{ dBm}$, 2110-2170 MHz

Power Gain	G_{ps}	31	34	—	dB
Gain Flatness	G_F	—	0.3	0.5	dB
Input Return Loss	IRL	—	-12	-10	dB
Group Delay	—	—	1.7	—	ns
Phase Linearity	—	—	0.2	—	$^{\circ}$
1-Carrier W-CDMA Conditions: Adjacent Channel Power Ratio @ $P_{\text{out}} = 23 \text{ dBm}$, 5 MHz Offset	ACPR	—	-53	-50	dBc
1-Carrier W-CDMA Conditions: Adjacent Channel Power Ratio @ $P_{\text{out}} = 28 \text{ dBm}$, 5 MHz Offset	ACPR	—	-50	—	dBc

W-CDMA Characteristics (In Freescale Test Fixture, 50 ohm system) $V_{DD} = 27 \text{ Vdc}$, $I_{DQ1} = 56 \text{ mA}$, $I_{DQ2} = 61 \text{ mA}$, $I_{DQ3} = 117 \text{ mA}$, $P_{\text{out}} = 34 \text{ dBm}$, 2110-2170 MHz

Power Gain	G_{ps}	—	30	—	dB
Gain Flatness	G_F	—	0.2	—	dB
Input Return Loss	IRL	—	-12	—	dB
Power Added Efficiency	PAE	—	16	—	%
1-Carrier W-CDMA Conditions: Adjacent Channel Power Ratio @ $P_{\text{out}} = 34 \text{ dBm}$, 4 MHz Offset	ACPR	—	-45	—	dBc

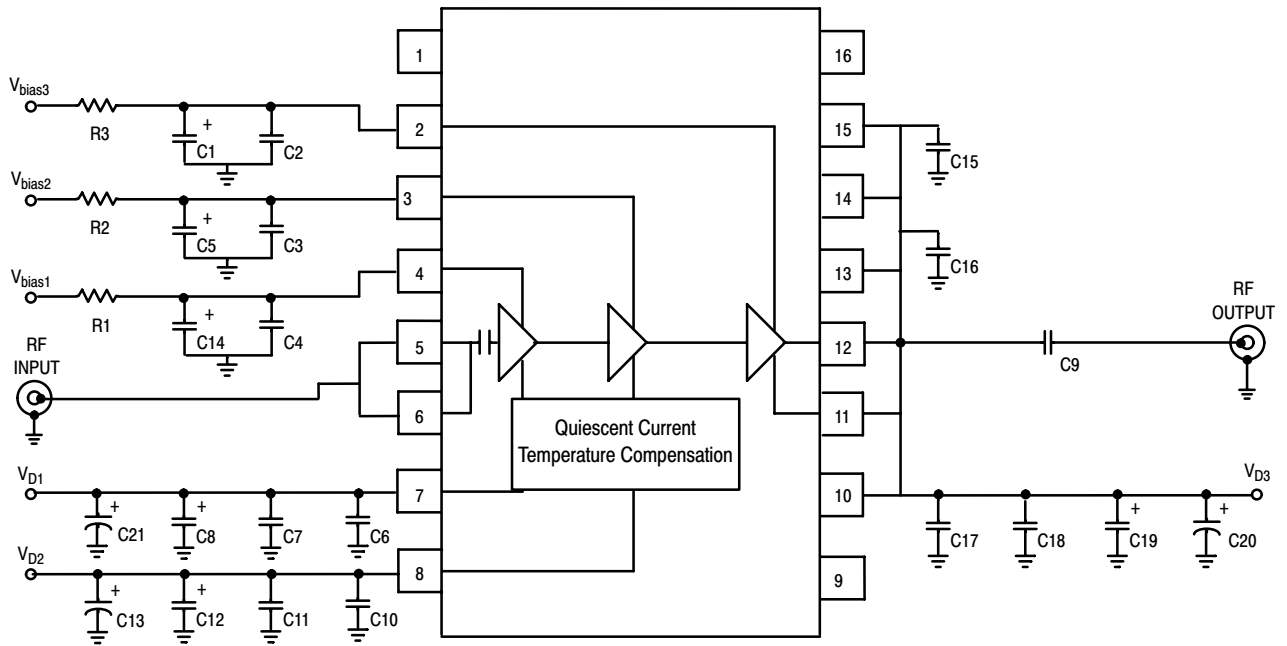

- | | | | |
|---------------------------|---------------------------------------------------|---------------|--------------------------------------------------|
| C1, C5, C8, C12, C14, C19 | 1 mF SMT Tantalum Chip Capacitors | C13, C20, C21 | 330 mF Electrolytic Capacitors (MCR35V337M10X16) |
| C2, C3, C4, C7, C11, C18 | 0.01 mF Chip Capacitors (0805C103K5RACTR) | R1, R2, R3 | 1 kW Chip Resistors (0805) |
| C6, C10, C17 | 6.8 pF Chip Capacitors, ACCU-P (AVX 08051J6R8BBT) | PCB | Arlon, 0.020,, $\epsilon_r = 2.55$ |
| C9, C15, C16 | 1.8 pF Chip Capacitors, ACCU-P (AVX 08051J1R8BBT) | | |

Figure 3. MHVIC2115NR2 Demo Board Schematic

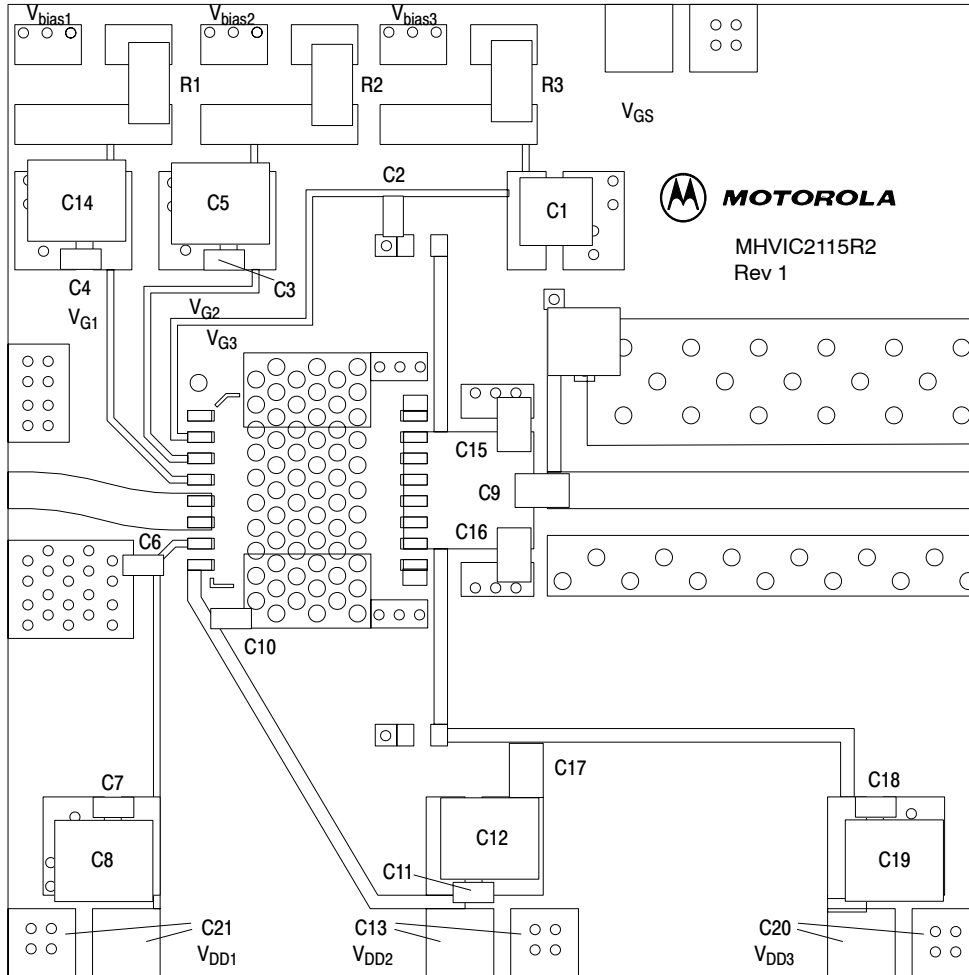

Freescall has begun the transition of marking Printed Circuit Boards (PCBs) with the Freescall Semiconductor signature/logo. PCBs may have either Motorola or Freescall markings during the transition period. These changes will have no impact on form, fit or function of the current product.

Figure 4. MHVIC2115NR2 Demo Board Component Layout

TYPICAL CHARACTERISTICS

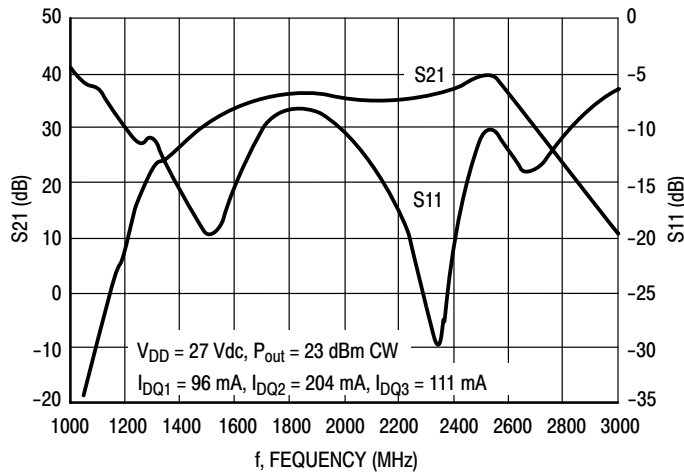

Figure 5. Broadband Frequency Response

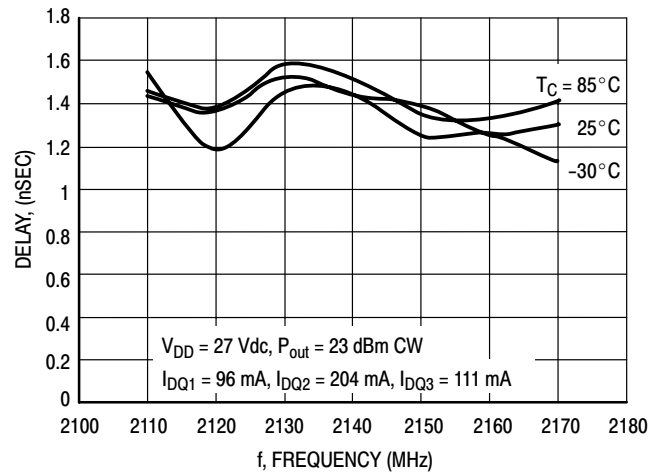

Figure 6. Delay versus Frequency

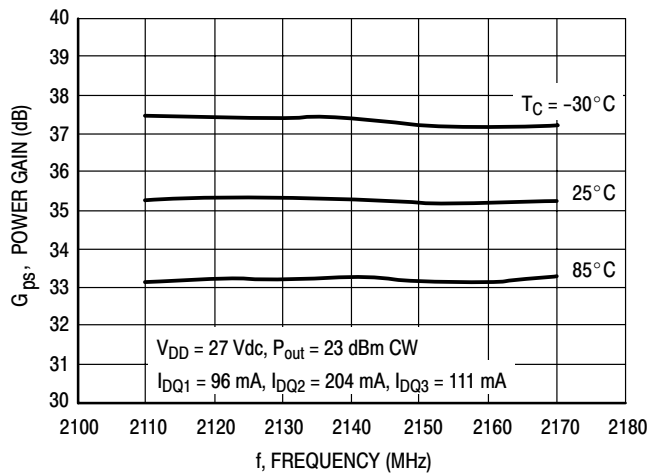

Figure 7. Power Gain versus Frequency

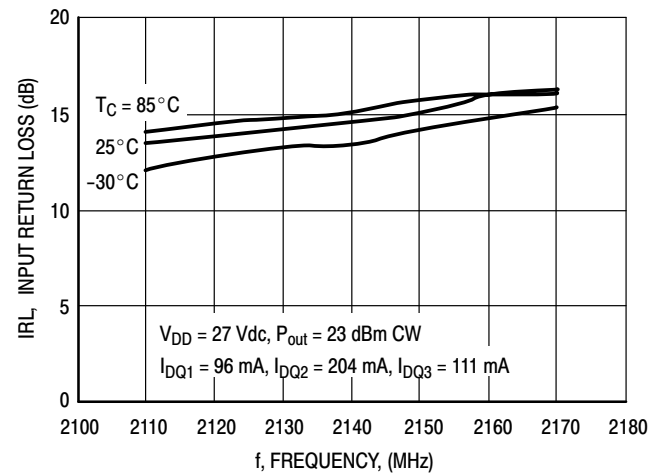

Figure 8. Input Return Loss versus Frequency

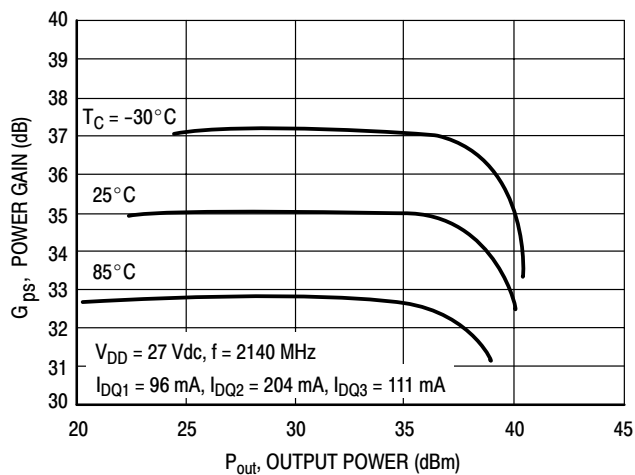

Figure 9. Power Gain versus Output Power

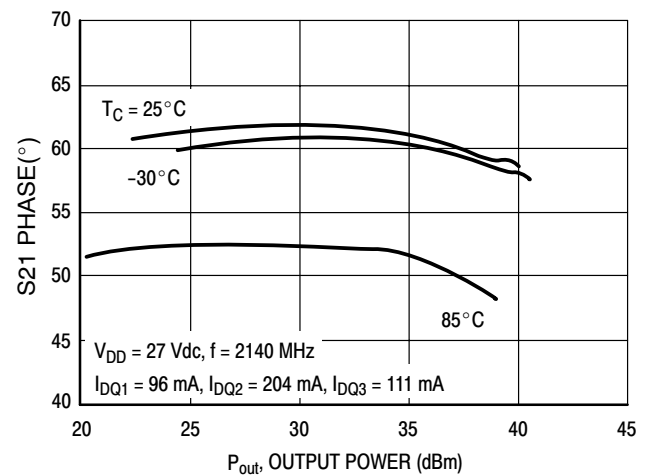

Figure 10. S21 Phase versus Output Power

TYPICAL CHARACTERISTICS

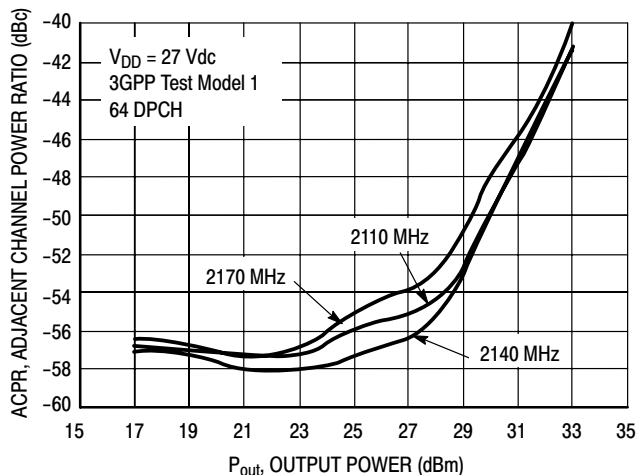

Figure 11. W-CDMA ACPR versus Output Power

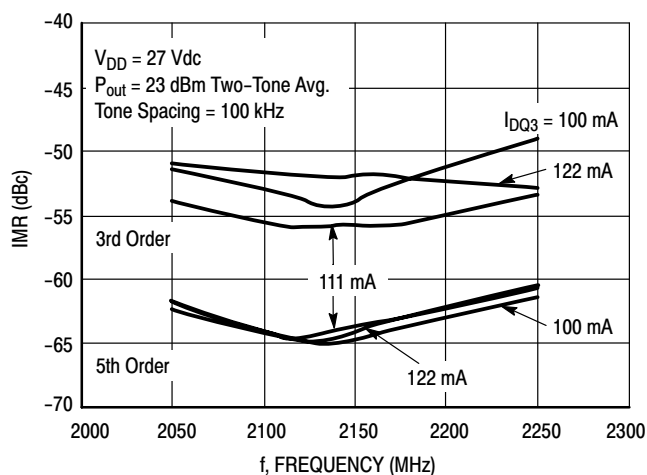

Figure 12. Two-Tone IMR versus Frequency

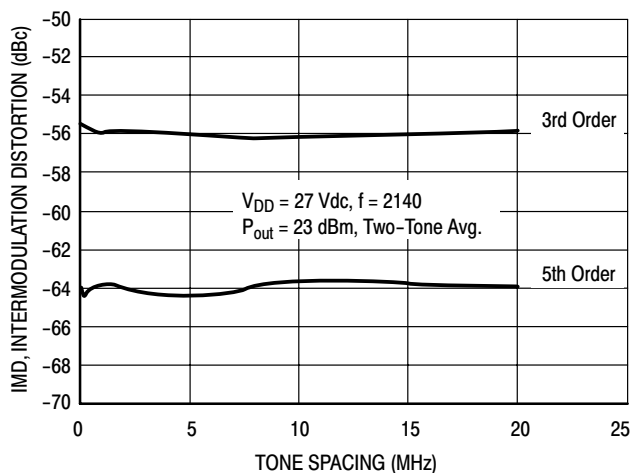

Figure 13. Two-Tone Broadband Performance

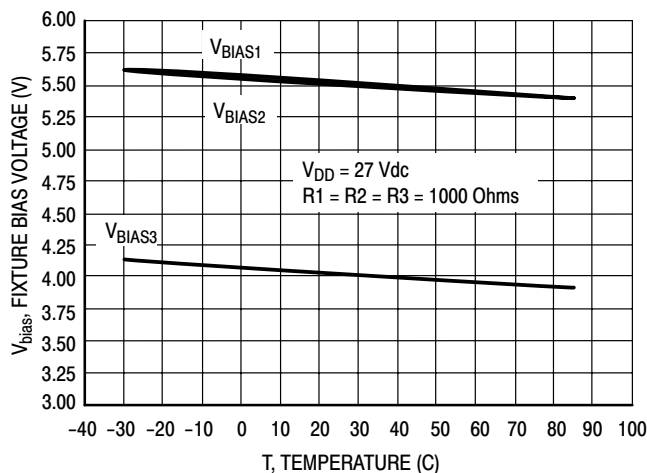

Figure 14. Fixture Bias versus Temperature

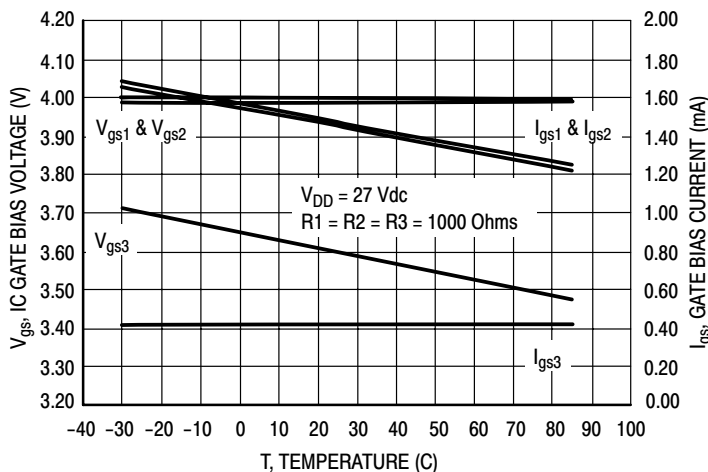
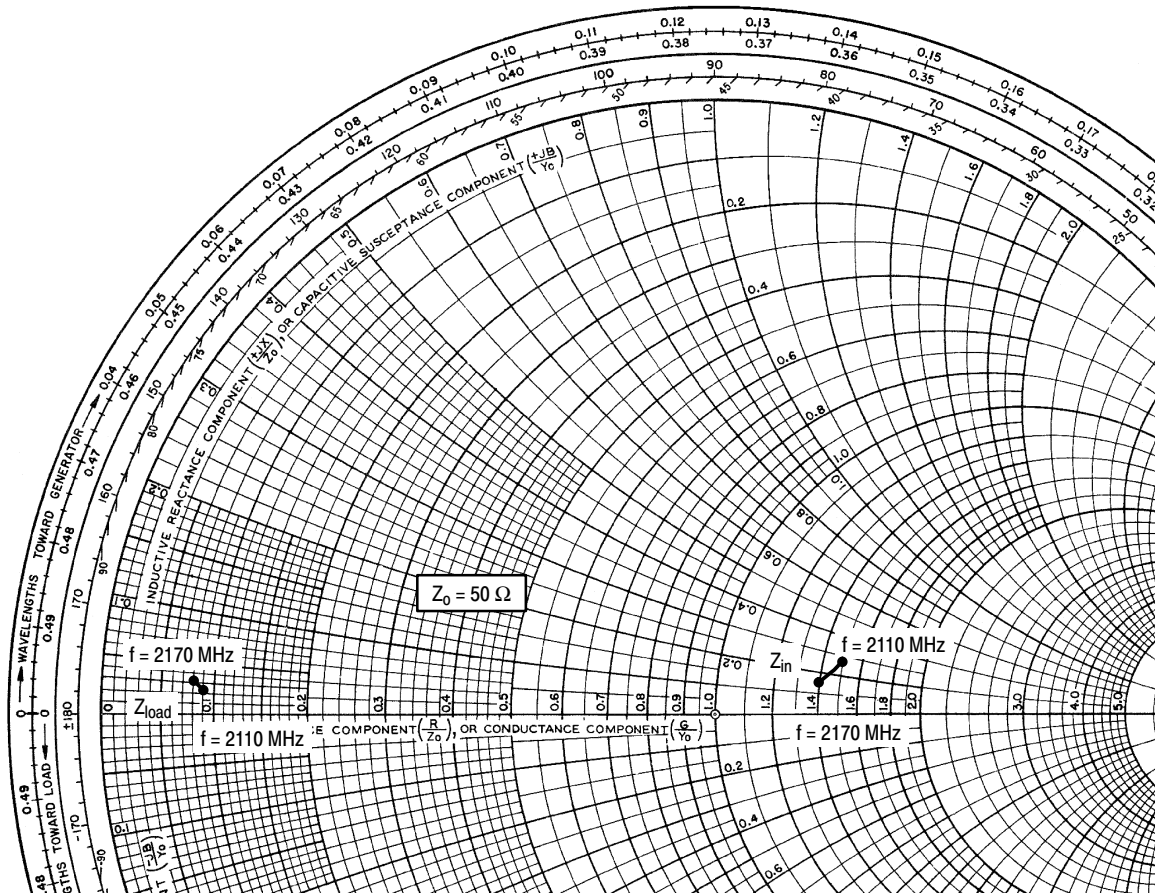

Figure 15. Gate Bias versus Temperature



$V_{DD} = 27 \text{ Vdc}$, $I_{DQ} = 1411 \text{ mA}$, $P_{out} = 15 \text{ W Avg.}$

f MHz	Z_{in} Ω	Z_{load} Ω
2110	$72.55 + j12.8$	$4.25 + j1.00$
2140	$71.40 + j9.9$	$4.13 + j1.37$
2170	$70.20 + j7.1$	$4.12 + j1.46$

Z_{in} = Device input impedance as measured from gate to ground.

Z_{load} = Test circuit impedance as measured from drain to ground.

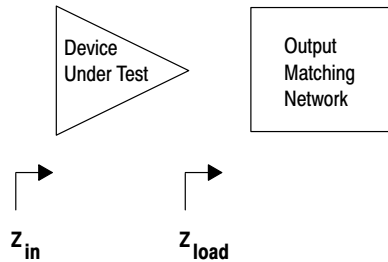

Figure 16. Series Equivalent Input and Load Impedance



NOTES



NOTES



NOTES

PACKAGE DIMENSIONS

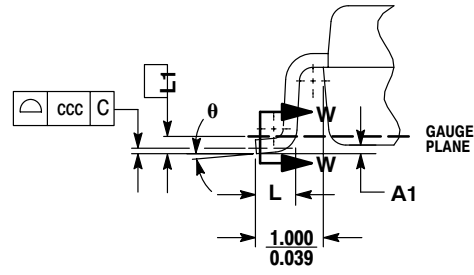
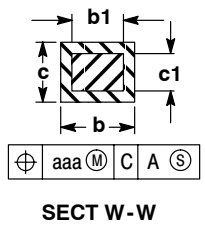
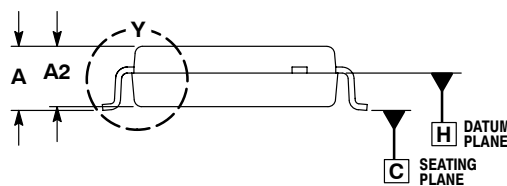
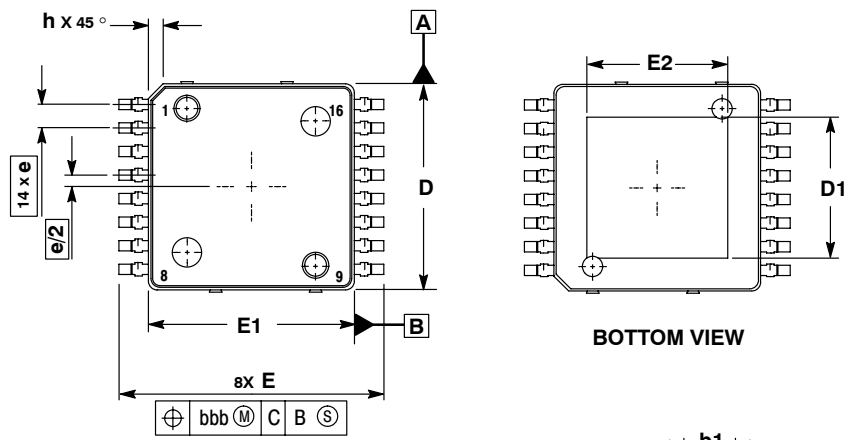

- NOTES:
1. CONTROLLING DIMENSION: MILLIMETER.
 2. DIMENSIONS AND TOLERANCES PER ASME Y14.5M, 1994.
 3. DATUM PLANE -H- IS LOCATED AT BOTTOM OF LEAD AND IS COINCIDENT WITH THE LEAD WHERE THE LEAD EXITS THE PLASTIC BODY AT THE BOTTOM OF THE PARTING LINE.
 4. DIMENSIONS D AND E1 DO NOT INCLUDE MOLD PROTRUSION. ALLOWABLE PROTRUSION IS 0.250 PER SIDE. DIMENSIONS D AND E1 DO INCLUDE MOLD MISMATCH AND ARE DETERMINED AT DATUM PLANE -H-.
 5. DIMENSION b DOES NOT INCLUDE DAMBAR PROTRUSION. ALLOWABLE DAMBAR PROTRUSION IS 0.127 TOTAL IN EXCESS OF THE b DIMENSION AT MAXIMUM MATERIAL CONDITION.
 6. DATUMS -A- AND -B- TO BE DETERMINED AT DATUM PLANE -H-.

DIM	MILLIMETERS	
	MIN	MAX
A	2.000	2.300
A1	0.025	0.100
A2	1.950	2.100
D	6.950	7.100
D1	4.372	5.180
E	8.850	9.150
E1	6.950	7.100
E2	4.372	5.180
L	0.466	0.720
L1	0.250 BSC	
b	0.300	0.432
b1	0.300	0.375
c	0.180	0.279
c1	0.180	0.230
e	0.800 BSC	
h	---	0.600
θ	0°	7°
aaa	0.200	
bbb	0.200	
ccc	0.100	

DETAIL Y

CASE 978-03
ISSUE C
PFP-16

How to Reach Us:

Home Page:

www.freescale.com

E-mail:

support@freescale.com

USA/Europe or Locations Not Listed:

Freescale Semiconductor
Technical Information Center, CH370
1300 N. Alma School Road
Chandler, Arizona 85224
+1-800-521-6274 or +1-480-768-2130
support@freescale.com

Europe, Middle East, and Africa:

Freescale Halbleiter Deutschland GmbH
Technical Information Center
Schatzbogen 7
81829 Muenchen, Germany
+44 1296 380 456 (English)
+46 8 52200080 (English)
+49 89 92103 559 (German)
+33 1 69 35 48 48 (French)
support@freescale.com

Japan:

Freescale Semiconductor Japan Ltd.
Headquarters
ARCO Tower 15F
1-8-1, Shimo-Meguro, Meguro-ku,
Tokyo 153-0064
Japan
0120 191014 or +81 3 5437 9125
support.japan@freescale.com

Asia/Pacific:

Freescale Semiconductor Hong Kong Ltd.
Technical Information Center
2 Dai King Street
Tai Po Industrial Estate
Tai Po, N.T., Hong Kong
+800 2666 8080
support.asia@freescale.com

For Literature Requests Only:

Freescale Semiconductor Literature Distribution Center
P.O. Box 5405
Denver, Colorado 80217
1-800-441-2447 or 303-675-2140
Fax: 303-675-2150
LDCForFreescaleSemiconductor@hibbertgroup.com

RoHS-compliant and/or Pb-free versions of Freescale products have the functionality and electrical characteristics of their non-RoHS-compliant and/or non-Pb-free counterparts. For further information, see <http://www.freescale.com> or contact your Freescale sales representative.

For information on Freescale's Environmental Products program, go to <http://www.freescale.com/epp>.

Information in this document is provided solely to enable system and software implementers to use Freescale Semiconductor products. There are no express or implied copyright licenses granted hereunder to design or fabricate any integrated circuits or integrated circuits based on the information in this document.

Freescale Semiconductor reserves the right to make changes without further notice to any products herein. Freescale Semiconductor makes no warranty, representation or guarantee regarding the suitability of its products for any particular purpose, nor does Freescale Semiconductor assume any liability arising out of the application or use of any product or circuit, and specifically disclaims any and all liability, including without limitation consequential or incidental damages. "Typical" parameters that may be provided in Freescale Semiconductor data sheets and/or specifications can and do vary in different applications and actual performance may vary over time. All operating parameters, including "Typicals", must be validated for each customer application by customer's technical experts. Freescale Semiconductor does not convey any license under its patent rights nor the rights of others. Freescale Semiconductor products are not designed, intended, or authorized for use as components in systems intended for surgical implant into the body, or other applications intended to support or sustain life, or for any other application in which the failure of the Freescale Semiconductor product could create a situation where personal injury or death may occur. Should Buyer purchase or use Freescale Semiconductor products for any such unintended or unauthorized application, Buyer shall indemnify and hold Freescale Semiconductor and its officers, employees, subsidiaries, affiliates, and distributors harmless against all claims, costs, damages, and expenses, and reasonable attorney fees arising out of, directly or indirectly, any claim of personal injury or death associated with such unintended or unauthorized use, even if such claim alleges that Freescale Semiconductor was negligent regarding the design or manufacture of the part.

Freescale™ and the Freescale logo are trademarks of Freescale Semiconductor, Inc. All other product or service names are the property of their respective owners.

© Freescale Semiconductor, Inc. 2006. All rights reserved.

RoHS-compliant and/or Pb-free versions of Freescale products have the functionality and electrical characteristics of their non-RoHS-compliant and/or non-Pb-free counterparts. For further information, see <http://www.freescale.com> or contact your Freescale sales representative.

For information on Freescale's Environmental Products program, go to <http://www.freescale.com/epp>.

