



MULTI-INNO TECHNOLOGY CO., LTD.

www.multi-inno.com

LCD MODULE SPECIFICATION

Model : MI0570ET-22CP1

This module uses ROHS material

For Customer's Acceptance:

Customer	
Approved	
Comment	

The standard product specification may change without prior notice in order to improve performance or quality. Please contact Multi-Inno for updated specification and product status before design for the standard product or release of the order.

Revision	1.0
Engineering	
Date	2015-08-25
Our Reference	

CONTENTS

- GENERAL INFORMATION
- EXTERNAL DIMENSIONS
- ABSOLUTE MAXIMUM RATINGS
- ELECTRICAL CHARACTERISTICS
- BACKLIGHT CHARACTERISTICS
- ELECTRO-OPTICAL CHARACTERISTICS
- INTERFACE DESCRIPTION
- BLOCK DIAGRAM
- APPLICATION NOTES
- CTP SPECIFICATIONS
- RELIABILITY TEST
- INSPECTION CRITERION
- PRECAUTIONS FOR USING LCD MODULES
- PRIOR CONSULT MATTER

■ GENERAL INFORMATION

Item	Contents	Unit
LCD type	TFT/Transmissive/Positive	/
Size	5.7	Inch
Viewing direction	6:00(without image inversion and least brightness change)	O' Clock
Gray scale inversion direction	12:00(contrast peak located at)	O' Clock
LCM (W × H × D)	127.0×98.43×7.70	mm ³
Active area (W×H)	115.2×86.4	mm ²
Pixel pitch (W×H)	0.18×0.18	mm ²
Number of dots	640 (RGB) × 480	/
Driver IC	HIMAX	/
Backlight type	21 LEDs	/
Interface type	18-bit RGB	/
Color depth	262K	/
Pixel configuration	R.G.B vertical stripe	/
Top polarizer surface treatment	Clear	/
Input voltage	3.3	V
With/Without TSP	With CTP	/
TP surface treatment	TBD	/
Weight	TBD	g

Note 1: RoHS compliant;

Note 2: LCM weight tolerance: ± 5% .

EXTERNAL DIMENSIONS

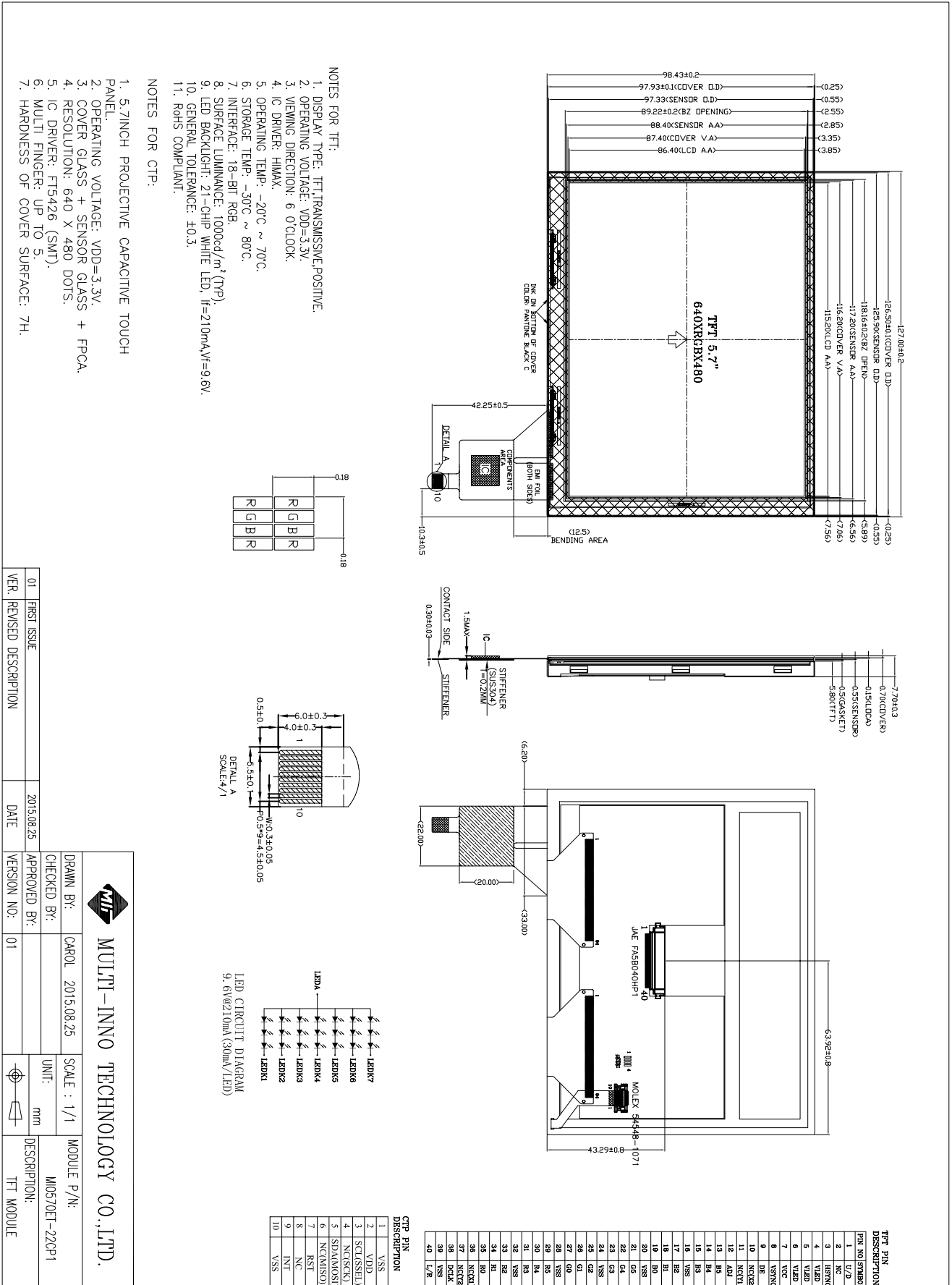

**■ABSOLUTE MAXIMUM RATINGS**

Parameter	Symbol	Min	Max	Unit
Power supply voltage	V _{CC}	-0.3	5.0	V
Logic input voltage	V _I	-0.3	V _{CC} +0.3	V
Operating temperature	T _{OP}	-20	70	°C
Storage temperature	T _{ST}	-30	80	°C
Humidity	RH	-	90%(Max60°C)	RH

■ELECTRICAL CHARACTERISTICS

Parameter	Symbol	Min	Typ	Max	Unit
Power supply voltage for LCD	V _{CC}	3.0	3.3	3.6	V
Power supply current for LCD	I _{CC}	-	111	140	mA
Power supply voltage for LED	V _{LED}	4.5	5.0	5.5	V
Power supply current for LED	I _{LED}	-	333	400	mA
Ripple voltage	V _{RF}	-	-	100	mVp-p
Input voltage 'H' level	V _{IH}	0.7V _{CC}	-	V _{CC}	V
Input voltage 'L' level	V _{IL}	0	-	0.3V _{CC}	V
ADJ frequency		19K	20K	21K	Hz
ADJ input voltage	V _{IH}	3.0	-	3.3	V
	V _{IL}	0	-	0.3	V
LED dice life time		-	50,000	-	Hr

Note 1: The “LED dice life time” is defined as the brightness decrease to 50% original brightness that the ambient temperature is 22°C and LED dice current=20mA.

■ELECTRO-OPTICAL CHARACTERISTICS

Item	Symbol	Condition	Min	Typ	Max	Unit	Remark	Note
Response time	Tr+Tf	$\theta=0^\circ$ $\varnothing=0^\circ$ $Ta=25^\circ C$	-	50	-	ms	FIG 1.	4
Contrast ratio	Cr		200	300	-	---	FIG 2.	1
Luminance uniformity	δ WHITE		70	80	-	%	FIG 2.	3
Surface Luminance	Lv		-	850	-	cd/m ²	FIG 2.	2
Viewing angle range	θ	$\varnothing = 90^\circ$	50	60	-	deg	FIG 3.	6
		$\varnothing = 270^\circ$	30	40	-	deg	FIG 3.	
		$\varnothing = 0^\circ$	60	70	-	deg	FIG 3.	
		$\varnothing = 180^\circ$	60	70	-	deg	FIG 3.	
CIE (x, y) chromaticity	Red	x	0.565	0.615	0.665	FIG 2.	5	
		y	0.310	0.360	0.410			
	Green	x	0.295	0.345	0.395			
		y	0.490	0.540	0.590			
	Blue	x	0.098	0.148	0.198			
		y	0.056	0.106	0.156			
	White	x	0.259	0.309	0.359			
		y	0.270	0.320	0.370			

Note 1. Contrast Ratio(CR) is defined mathematically as For more information see FIG 2.

$$\text{Contrast Ratio} = \frac{\text{Average Surface Luminance with all white pixels (P1, P2, P3, P4, P5)}}{\text{Average Surface Luminance with all black pixels (P1, P2, P3, P4, P5)}}$$

Note 2. Surface luminance is the LCD surface from the surface with all pixels displaying white. For more information see FIG 2.

$$Lv = \text{Average Surface Luminance with all white pixels (P1, P2, P3, P4, P5)}$$

Note 3. The uniformity in surface luminance , δ WHITE is determined by measuring luminance at each test position 1 through 5, and then dividing the maximum luminance of 5 points luminance by minimum luminance of 5 points luminance. For more information see FIG 2.

$$\delta \text{ WHITE} = \frac{\text{Minimum Surface Luminance with all white pixels (P1, P2, P3, P4, P5)}}{\text{Maximum Surface Luminance with all white pixels (P1, P2, P3, P4, P5)}}$$

Note 4. Response time is the time required for the display to transition from White to black(Rise Time, Tr) and from black to white(Decay Time, Tf). For additional information see FIG 1. The test equipment is Autronic-Melchers's ConoScope. Series.

Note 5. CIE (x, y) chromaticity, The x, y value is determined by measuring luminance at each test position 1 through 5, and then make average value.

Note 6. Viewing angle is the angle at which the contrast ratio is greater than 2. For TFT module the contrast ratio is greater than 10. The angles are determined for the horizontal or x axis and the vertical or y axis with respect to the z axis which is normal to the LCD surface. For more information see FIG 3.

Note 7. For viewing angle and response time testing, the testing data is base on Autronic-Melchers's ConoScope. Series Instruments For contrast ratio, Surface Luminance, Luminance uniformity, CIE The test data is base on TOPCON's BM-5 photo detector.

FIG. 1 The definition of Response Time

The response time is defined as the following figure and shall be measured by switching the input signal for "black" and "white".

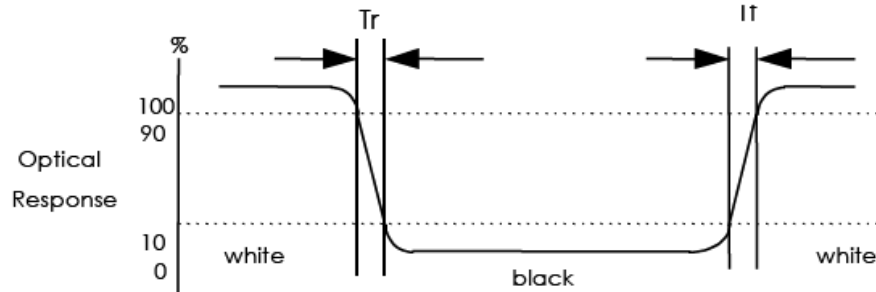
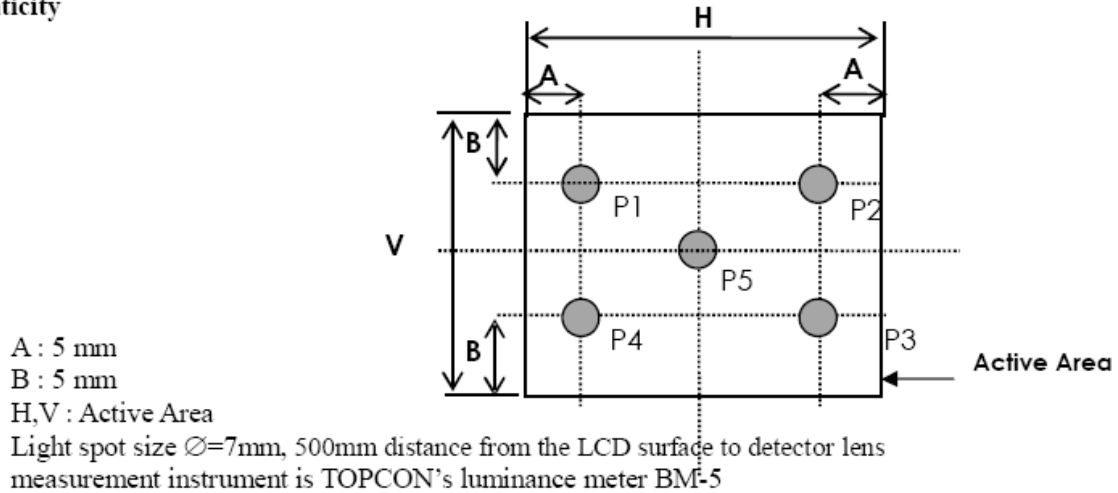
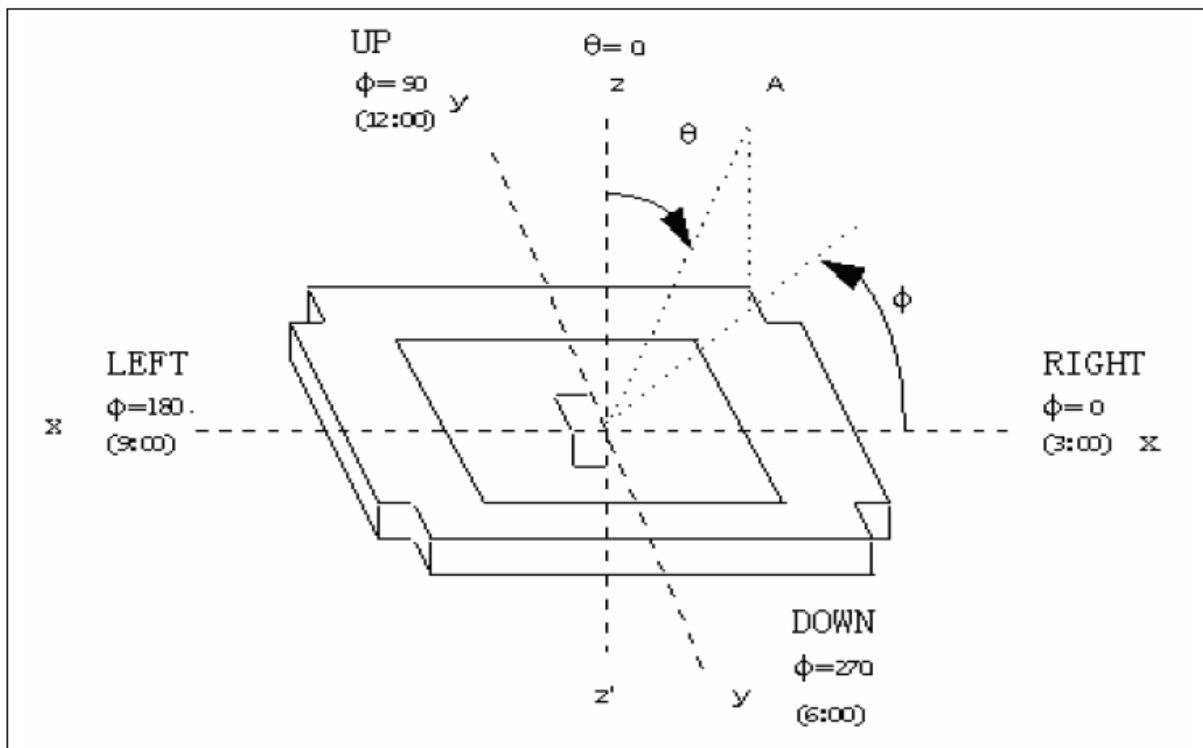
FIG. 2 Measuring method for Contrast ratio, surface luminance, Luminance uniformity , CIE (x, y) chromaticity

FIG. 3 The definition of viewing angle

■ INTERFACE DESCRIPTION

Pin NO.	SYMBOL	DESCRIPTION
1	U/D	Up or Down Display Control
2	NC	No Connection
3	Hsync	Horizontal SYNC.
4	VLED	Power Supply for LED Driver circuit
5	VLED	Power Supply for LED Driver circuit
6	VLED	Power Supply for LED Driver circuit
7	Vcc	Power Supply for LCD
8	Vsync	Vertical SYNC.
9	DE	Data Enable
10	NC(X2)	No Connection
11	NC(Y1)	No Connection
12	ADJ	Brightness control for LED B/L
13	B5	Blue Data 5 (MSB)
14	B4	Blue Data 4
15	B3	Blue Data 3
16	Vss	Power Ground
17	B2	Blue Data 2
18	B1	Blue Data 1
19	B0	Blue Data 0 (LSB)
20	Vss	Power Ground
21	G5	Green Data 5 (MSB)
22	G4	Green Data 4
23	G3	Green Data 3
24	Vss	Power Ground
25	G2	Green Data 2
26	G1	Green Data 1
27	G0	Green Data 0 (LSB)
28	Vss	Power Ground
29	R5	Red Data 5 (MSB)
30	R4	Red Data 4
31	R3	Red Data 3
32	Vss	Power Ground
33	R2	Red Data 2
34	R1	Red Data 1
35	R0	Red Data 0
36	NC(X1)	No Connection
37	NC(Y2)	No Connection
38	DCLK	Clock Signals ; Latch Data at the Falling Edge
39	Vss	Power Ground
40	L/R	Left or Right Display Control

Remarks :

- 1) ADJ is brightness control Pin. The larger of the pulse duty is, the higher of the brightness.
- 2) ADJ signal is 0~3.3V. Operation frequency is 20KHz
- 3) VSS PIN must be grounding, can not be floating.

■ BLOCK DIAGRAM

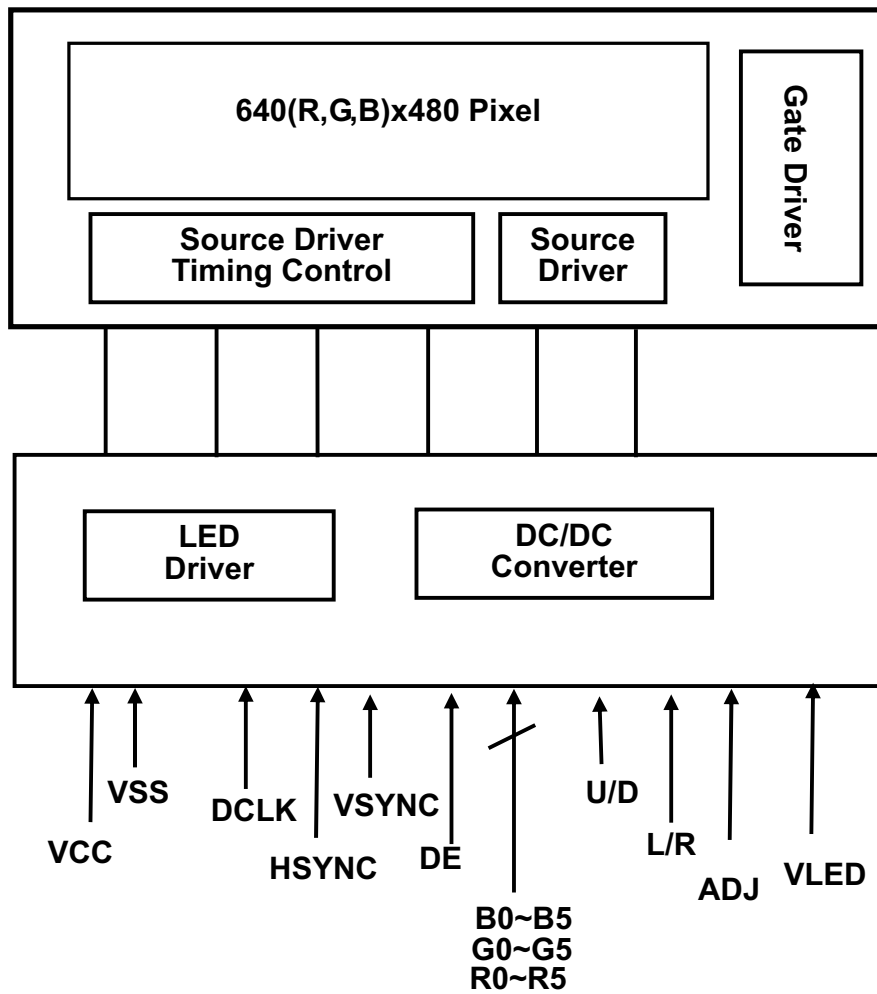

■ APPLICATION NOTES

1. INTERFACE SPECIFICATIONS

1.1 DE mode Input signal characteristics

Signal	Parameter	Symbol	MIN.	TYP.	MAX.	Unit	Remarks
DCLK	Period	t_{CLK}	33	40	43	ns	
	Frequency	f_{CLK}	23	25	30	MHz	
	Low Level Width	t_{WCL}	6	-	-	ns	
	High Level Width	t_{WCH}	6	-	-	ns	
	Rise, Fall Time	t_{CLKr}, t_{CLKf}	-	-	3	ns	
	Duty	-	0.45	0.50	0.55	-	
DE (Data Enable)	Setup Time	t_{DES}	5	-	-	ns	
	Hold Time	t_{DEH}	10	-	-	ns	
	Rise, Fall Time	t_{DEr}, t_{DEf}	-	-	16	ns	
	Horizontal Period	t_{HP}	750	800	900	t_{CLK}	
	Horizontal Valid	t_{HV}	640	640	640	t_{CLK}	
	Horizontal Blank	t_{HBK}	110	160	260	t_{CLK}	
	Vertical Period	t_{VP}	515	525	560	t_{HP}	
	Vertical Valid	t_W	480	480	480	t_{HP}	
	Vertical Blank	t_{VBK}	35	45	80	t_{HP}	
	Vertical Frequency	f_V	55	60	65	Hz	
	Data R,G,B	Setup Time	t_{DS}	5	-	-	ns
Hold Time		t_{DH}	10	-	-	ns	
Rise, Fall Time		t_{Dr}, t_{Df}	-	-	3	ns	

Note: (1) t_{CLKL} / t_{CLK} .

1.1.1 DE mode timing waveform

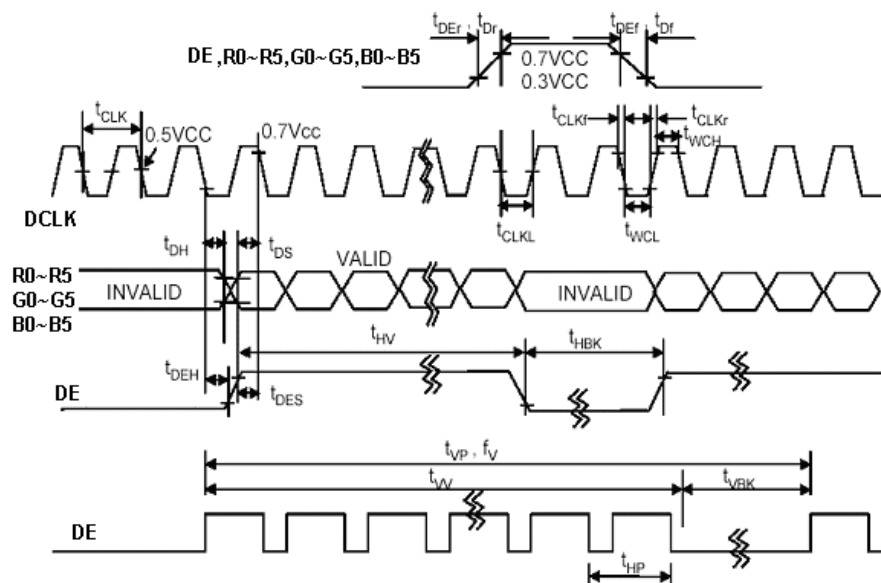

1.2 SYNC mode Input signal characteristics

Parameter	Symbol	MIN.	TYP.	MAX.	Unit	Remarks
Clock Period	t_{CLK}	33	40	43	ns	
Clock Frequency	f_{CLK}	23	25	30	MHz	
Clock Low Level Width	t_{WCL}	6	-	-	ns	
Clock High Level Width	t_{WCH}	6	-	-	ns	
Clock Rise, Fall Time	t_{CLKr}, t_{CLKf}	-	-	3	ns	
HSYNC Period	t_{HP}	750	800	900	t_{CLK}	
HSYNC Pulse Width	t_{HW}	5	30	-	t_{CLK}	
HSYNC Front Porch	t_{HFP}	1	16	116	t_{CLK}	
HSYNC Back Porch	t_{HBP}	1	114	139	t_{CLK}	
HSYNC Width + Back Porch	$t_{HW} + t_{HBP}$	144	144	144	t_{CLK}	
Horizontal Blank	t_{HBK}	1	160	260	t_{CLK}	
Horizontal Valid	t_{HV}	640	640	640	t_{CLK}	
VSYNC Period	t_{VP}	515	525	560	t_{HP}	
VSYNC Pulse Width	t_{VW}	1	3	5	t_{HP}	
VSYNC Front Porch	t_{VFP}	1	10	45	t_{HP}	
VSYNC Back Porch	t_{VBP}	30	32	34	t_{HP}	
VSYNC Width + Back Porch	$t_{VW} + t_{VBP}$	35	35	35	t_{CLK}	
Vertical Blank	t_{VBK}	35	45	80	t_{HP}	
Valid data Width	t_W	480	480	480	t_{HP}	
Data Setup Time	t_{DS}	5	-	-	ns	
Data Hold Time	t_{DH}	10	-	-	ns	

Note: (1) $t_{HBK} = t_{HFP} + t_{HW} + t_{HBP}$

1.2.1 SYNC mode timing waveform

1.2.1.1 Input vertical timing

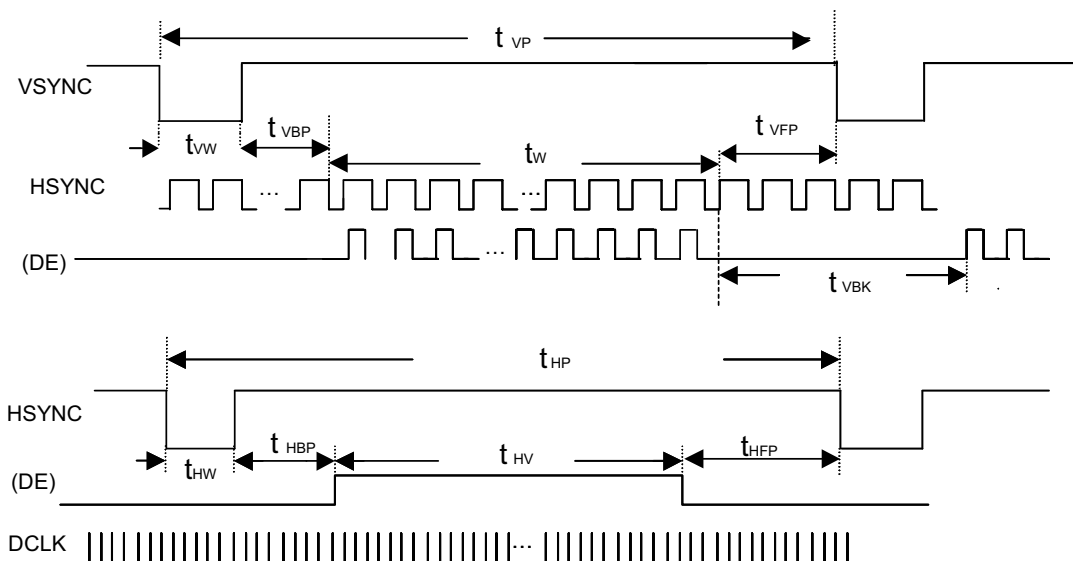

Remark : If SYNC mode is used, please fix DE signal to low, DE timing waveform is for reference only.

1.2.1.2 Input horizontal timing

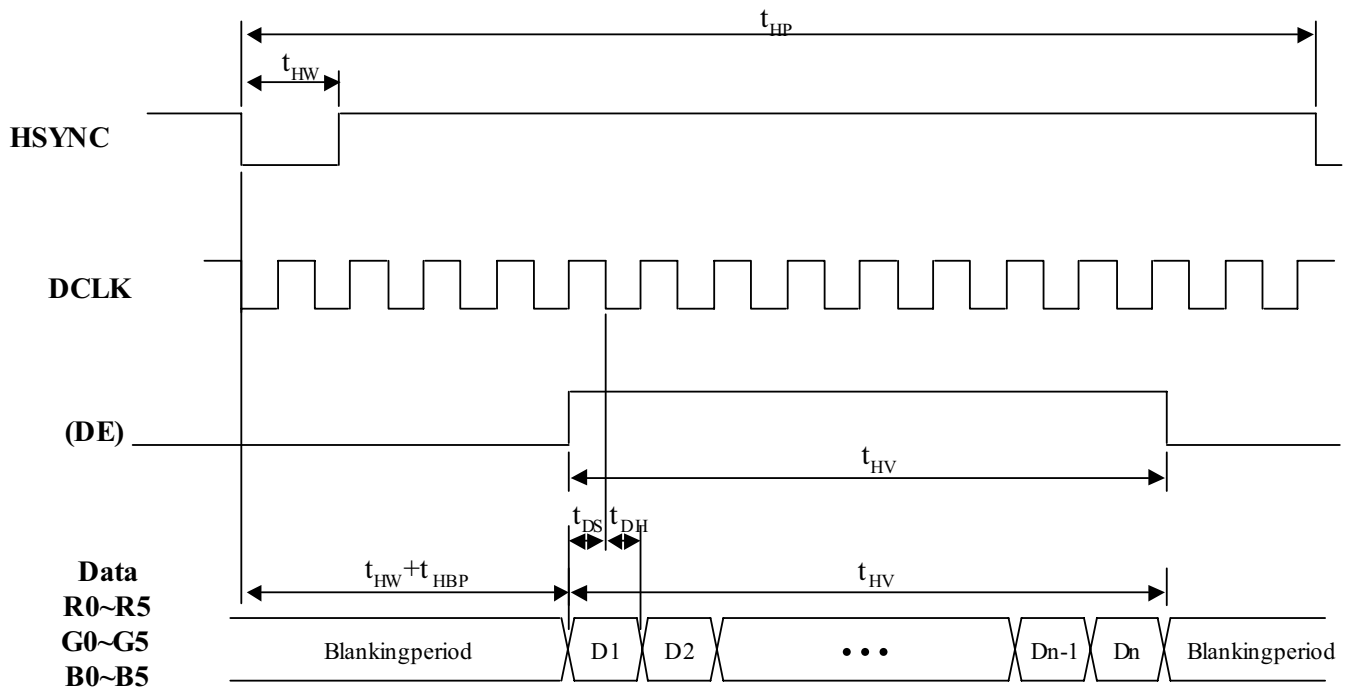

Remark : If SYNC mode is used, please fix DE signal to low, DE timing waveform is for reference only.



1.3 Color Data Assignment

COLOR	INPUT	R DATA						G DATA						B DATA						
		DATA	R5	R4	R3	R2	R1	R0	G5	G4	G3	G2	G1	G0	B5	B4	B3	B2	B1	B0
			MSB					LSB	MSB					LSB	MSB					LSB
BASIC COLOR	BLACK	0	0	0	0	0	0	0	0	0	0	0	0	0	0	0	0	0	0	0
	RED(63)	1	1	1	1	1	1	0	0	0	0	0	0	0	0	0	0	0	0	0
	GREEN(63)	0	0	0	0	0	0	1	1	1	1	1	1	0	0	0	0	0	0	0
	BLUE(63)	0	0	0	0	0	0	0	0	0	0	0	0	1	1	1	1	1	1	1
	CYAN	0	0	0	0	0	0	1	1	1	1	1	1	1	1	1	1	1	1	1
	MAGENTA	1	1	1	1	1	1	0	0	0	0	0	0	1	1	1	1	1	1	1
	YELLOW	1	1	1	1	1	1	1	1	1	1	1	1	0	0	0	0	0	0	0
	WHITE	1	1	1	1	1	1	1	1	1	1	1	1	1	1	1	1	1	1	1
RED	RED(0)	0	0	0	0	0	0	0	0	0	0	0	0	0	0	0	0	0	0	0
	RED(1)	0	0	0	0	0	1	0	0	0	0	0	0	0	0	0	0	0	0	0
	RED(2)	0	0	0	0	1	0	0	0	0	0	0	0	0	0	0	0	0	0	0
	:	:	:	:	:	:	:	:	:	:	:	:	:	:	:	:	:	:	:	:
	:	:	:	:	:	:	:	:	:	:	:	:	:	:	:	:	:	:	:	:
	RED(62)	1	1	1	1	1	0	0	0	0	0	0	0	0	0	0	0	0	0	0
	RED(63)	1	1	1	1	1	1	0	0	0	0	0	0	0	0	0	0	0	0	0
GREEN	GREEN(0)	0	0	0	0	0	0	0	0	0	0	0	0	0	0	0	0	0	0	0
	GREEN(1)	0	0	0	0	0	0	0	0	0	0	0	1	0	0	0	0	0	0	0
	GREEN(2)	0	0	0	0	0	0	0	0	0	0	1	0	0	0	0	0	0	0	0
	:	:	:	:	:	:	:	:	:	:	:	:	:	:	:	:	:	:	:	:
	:	:	:	:	:	:	:	:	:	:	:	:	:	:	:	:	:	:	:	:
	GREEN(62)	0	0	0	0	0	0	1	1	1	1	1	0	0	0	0	0	0	0	0
	GREEN(63)	0	0	0	0	0	0	1	1	1	1	1	1	0	0	0	0	0	0	0
BLUE	BLUE(0)	0	0	0	0	0	0	0	0	0	0	0	0	0	0	0	0	0	0	0
	BLUE(1)	0	0	0	0	0	0	0	0	0	0	0	0	0	0	0	0	0	0	1
	BLUE(2)	0	0	0	0	0	0	0	0	0	0	0	0	0	0	0	0	0	1	0
	:	:	:	:	:	:	:	:	:	:	:	:	:	:	:	:	:	:	:	:
	:	:	:	:	:	:	:	:	:	:	:	:	:	:	:	:	:	:	:	:
	BLUE(62)	0	0	0	0	0	0	0	0	0	0	0	0	1	1	1	1	1	1	0
	BLUE(63)	0	0	0	0	0	0	0	0	0	0	0	0	1	1	1	1	1	1	1

Remarks:(1) Definition of Gray Scale
 color(n):n is series of Gray Scale
 The more n value is, the bright Gray Scale.
 (2)Data:1-High,0-Low

Correspondence between Data and Display Position

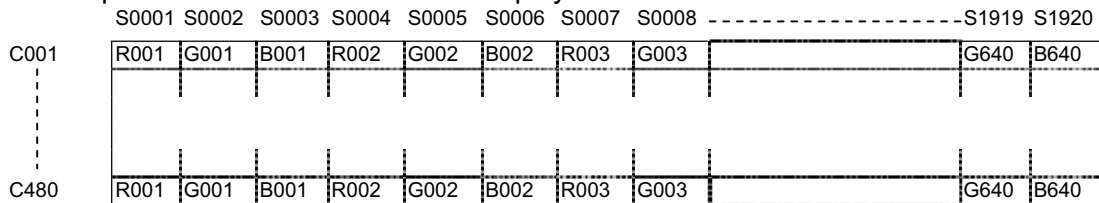

■ CTP SPECIFICATIONS

1. GENERAL SPECIFICATIONS

Item	Specification	Unit
Type	Projective capacitive type touch panel	
Structure	Cover glass+Sensor glass+FPCA	
Input mode	Human's finger	
Finger	Up to 5	
Resolution	640 x 480	dots
Cover viewing area	116.2(W) x 87.4(H)	mm
Sensor Active Area	117.2(W) x 88.4(H)	mm
Hardness	7H	Pencil hardness
Driver IC	FT5426(SMT)	/

2. ABSOLUTE MAXIMUM RATINGS

Symbol	Description	Min	Typ.	Max	Unit	Notes
VDD	Supply voltage for logic	2.8	3.3	3.6	V	
IDD	Supply current for logic	-	TBD	-	mA	

3. PIN CONNECTIONS

No.	Name	I/O	Description
1	VSS	P	Ground
2	VDD	P	Power supply
3	SCL(SSEL)	I	I2C clock input
4	NC(SCK)	-	No connection
5	SDA(MOSI)	I/O	I2C data signal
6	NC(MISO)	-	No connection.
7	RST	I/O	Reset.active low
8	NC	-	No connection
9	INT	P	Interrupt signal to host from CTP
10	VSS	P	Ground

4. BLOCK DIAGRAM

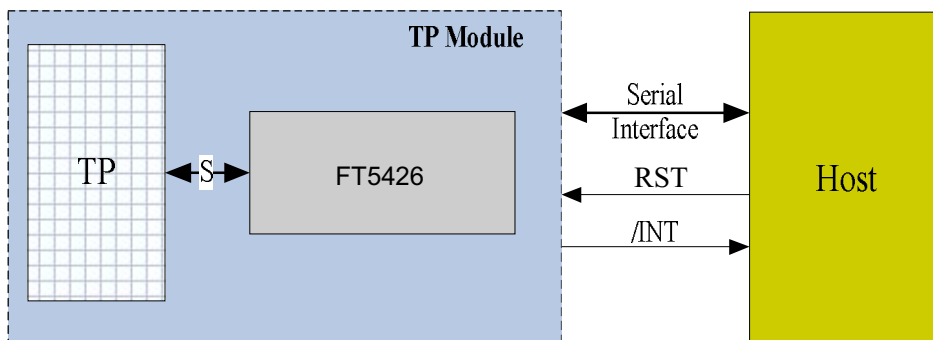

5. CTP TIMING

The I2C is always configured in the Slave mode. The data transfer format is shown in Figure 1-1.

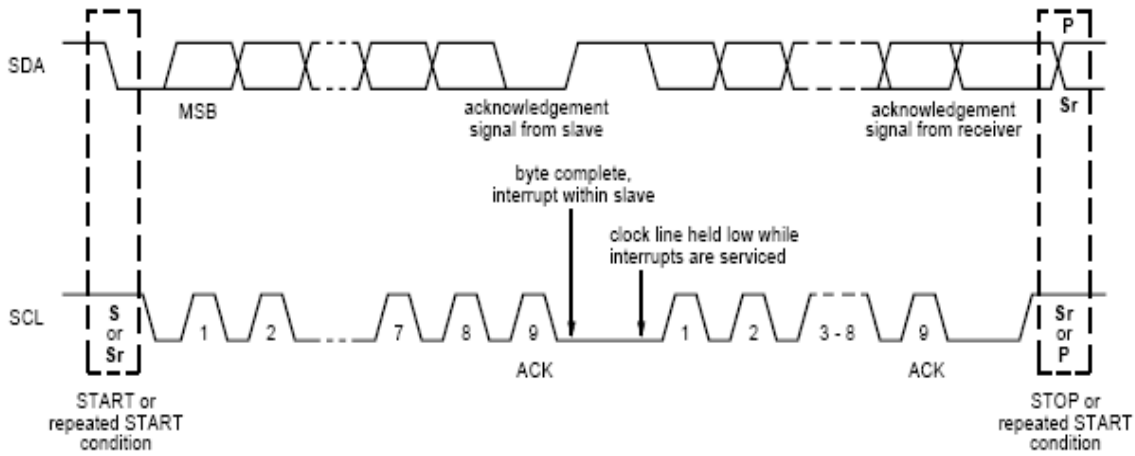

Figure 1-1 I2C Serial Data Transfer Format

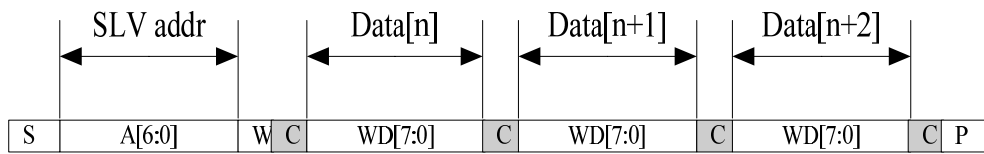

Figure 1-2 I2C master write, slave read

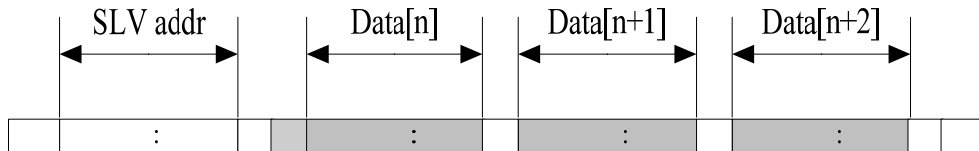

Figure 1-3 I2C master read, slave write

Table 1-1 lists the meanings of the mnemonics used in the above figures.

Table 1-1 Mnemonics Description

Mnemonics	Description
S	I2C Start or I2C Restart
A[6:0]	Slave address A[6:4]: 3'b011 A[3:0]: data bits are identical to those of I2CCON[7:4] register.
W	1'b0: Write
R	1'b1: Read
C	ACK
P	STOP: the indication of the end of a packet (if this bit is missing, S will indicate the end of the current packet and the beginning of the next packet)



I2C Interface Timing Characteristics is shown in Table 1-2.

Table 1-2 I2C Timing Characteristics

Parameter	Unit	Min	Max
SCL frequency	KHz	0	400
Bus free time between a STOP and START condition	us	4.7	\
Hold time (repeated) START condition	us	4.0	\
Data setup time	ns	250	\
Setup time for a repeated START condition	us	4.7	\
Setup Time for STOP condition	us	4.0	\

Note: More information pls refer to IC spec.

■ RELIABILITY TEST

No.	Test Item	Test Condition
1	High Temperature Storage	$80 \pm 2^{\circ}\text{C}/240$ hours
2	Low Temperature Storage	$-30 \pm 2^{\circ}\text{C}/240$ hours
3	High Temperature Operating	$70 \pm 2^{\circ}\text{C}/240$ hours
4	Low Temperature Operating	$-20 \pm 2^{\circ}\text{C}/240$ hours
5	Temperature Cycle storage (non-operation)	$-30 \pm 2^{\circ}\text{C} \sim 25 \sim 80 \pm 2^{\circ}\text{C} \times 200$ cycles (30min.) (5min.) (30min.)
6	Damp Proof Test (operation)	$60^{\circ}\text{C} \pm 5^{\circ}\text{C} \times 90\%\text{RH}/240$ hours
7	Vibration Test (non-operation)	Frequency: 0~55Hz Amplitude: 1.5mm Sweep time: 11min 6 cycles for each direction of X.Y.Z
8	ESD test (non-operation)	150pF, 330 Ω Air: $\pm 12\text{KV}$; Contact: $\pm 6\text{KV}$ 10 times/point; 4 points/panel face

■ INSPECTION CRITERION

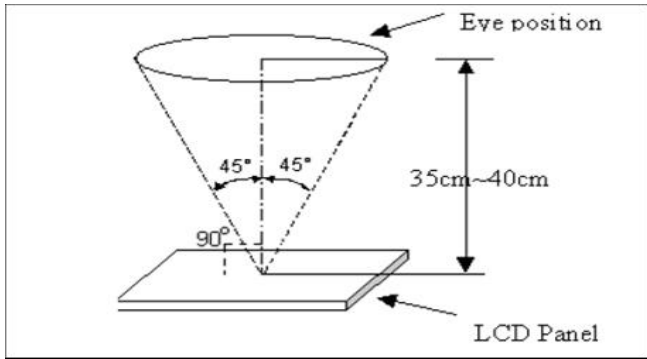
 OUTGOING QUALITY STANDARD	PAGE 1 OF 5
TITLE:FUNCTIONAL TEST & INSPECTION CRITERIA	
<p>This specification is made to be used as the standard acceptance/rejection criteria for Color mobile phone LCM.</p> <p>1 Sample plan</p> <p>1.1 Lot size: Quantity per shipment lot per model</p> <p>1.2 Sampling type: Normal inspection,Single sampling</p> <p>1.3 Inspection level: II</p> <p>1.4 Sampling table: MIL-STD-105D</p> <p>1.5 Acceptable quality level (AQL)</p> <p> Major defect: AQL=0.65</p> <p> Minor defect: AQL=1.00</p> <p>2. Inspection condition</p> <p>2.1 Ambient conditions:</p> <p> a. Temperature: Room temperature $25 \pm 5^\circ\text{C}$</p> <p> b. Humidity: $(60 \pm 10)\% \text{RH}$</p> <p> c. Illumination: Single fluorescent lamp non-directive (300 to 700 Lux)</p> <p>2.2 Viewing distance:</p> <p> The distance between the LCD and the inspector' s eyes shall be at least $35 \pm 5\text{cm}$.</p> <p>2.3 Viewing Angle</p> <p> U/D: $45^\circ / 45^\circ$, L/R: $45^\circ / 45^\circ$</p> <div data-bbox="429 1305 1078 1662" data-label="Diagram">  </div>	

	OUTGOING QUALITY STANDARD	PAGE 2 OF 5
---	---------------------------	-------------

TITLE:FUNCTIONAL TEST & INSPECTION CRITERIA

3. Inspection standards

Defects are classified as major defects and minor defects according to the degree of defectiveness defined herein.

3.1 Major defect

Item No	Items to be inspected	Inspection Standard
3.1.1	All functional defects	1) No display 2) Display abnormally 3) Short circuit 4) line defect
3.1.2	Missing	Missing function component
3.1.3	Crack	Glass crack

3.2 Minor defect

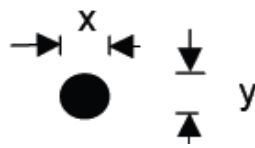
Item No	Items to be inspected	Inspection standard	
3.2.1	Spot Defect Including Black spot White spot Pinhole Foreign particle Polarizer dirt	For dark/white spot is defined $\varphi = (x+y) / 2$ 	
		Size φ (mm)	Acceptable Quantity
		$\varphi \leq 0.20$	Ignore
		$0.20 < \varphi \leq 0.50$	3
		$0.50 < \varphi$	Not allowed

OUTGOING QUALITY STANDARD		PAGE 3 OF 5	
TITLE:FUNCTIONAL TEST & INSPECTION CRITERIA			
3.2.2	Line Defect Including Black line White line Scratch	Define: 	
		Width(mm) Length(mm)	Acceptable Quantity
		$W \leq 0.02$	Ignore
		$0.02 < W \leq 0.05$ $L \leq 5.0$	4
		$0.05 < W$	Not allowed
3.2.3	Polarizer Dent/Bubble	Size φ (mm)	Acceptable Quantity
		$\varphi \leq 0.25$	Ignore
		$0.25 < \varphi \leq 0.5$	3
		$0.5 < \varphi$	0
3.2.4	Electrical Dot Defect	Bright and Black dot define: 	
		Inspection pattern: Full white, Full black, Red, green and blue screens	
		Item	Acceptable Quantity
		Black dot defect	5
		Bright dot defect	2
Total Dot	5		

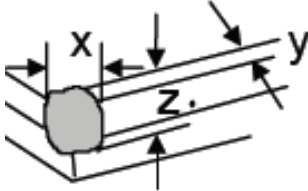
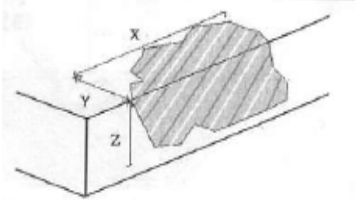
OUTGOING QUALITY STANDARD		PAGE 4 OF 5	
TITLE:FUNCTIONAL TEST & INSPECTION CRITERIA			
3.2.5	Touch panel defect	1. Corner Fragment: 	
		Size(mm)	Acceptable Quantity
		$X \leq 3\text{mm}$ $Y \leq 3\text{mm}$ $Z \leq T$	Ignore T: Glass thickness X: Length Y: Width Z: thickness
		2. Side Fragment: 	
		Size(mm)	Acceptable Quantity
		$X \leq 5.0\text{mm}$ $Y \leq 3\text{mm}$ $Z \leq T$	Ignore T: Glass thickness X: Length Y: Width Z: thickness
3.2.6	Touch panel spot	Size φ (mm)	Acceptable Quantity
		$\varphi \leq 0.25$	Ignore
		$0.25 < \varphi \leq 0.5$	4
		$0.5 < \varphi$	0

		OUTGOING QUALITY STANDARD		PAGE 5 OF 5	
TITLE:FUNCTIONAL TEST & INSPECTION CRITERIA					
3.2.7	Touch panel White line Scratch	Width(mm) Length(mm)		Acceptable Quantity	
		W≤0.03		Ignore	
		0.03 < W≤0.05 L≤5.0		4	
		0.05 < W or L>5		Not allowed	
3.2.8	Touch panel Newton ring	Compare with limit sample			

Note:

1. Dot defect is defined as the defective area of the dot area is larger than 50% of the dot area.
2. The distance between black dot defects or black and bright dot defects should be more than 5mm apart. The distance between two bright dot defects should be more than 15mm apart
3. Polarizer bubble is defined as the bubble appears on active display area. The defect of polarizer bubble shall be ignored if the polarizer bubble appears on the outside of active display area.
4. Mura is checker by 6% ND filter.
5. Foreign particle on the surface of the LCM should be ignore.

■ PRECAUTIONS FOR USING LCD MODULES

Handing Precautions

(1) The display panel is made of glass and polarizer. As glass is fragile. It tends to become or chipped during handling especially on the edges. Please avoid dropping or jarring. Do not subject it to a mechanical shock by dropping it or impact.

(2) If the display panel is damaged and the liquid crystal substance leaks out, be sure not to get any in your mouth. If the substance contacts your skin or clothes, wash it off using soap and water.

(3) Do not apply excessive force to the display surface or the adjoining areas since this may cause the color tone to vary. Do not touch the display with bare hands. This will stain the display area and degraded insulation between terminals (some cosmetics are determined to the polarizer).

(4) The polarizer covering the display surface of the LCD module is soft and easily scratched. Handle this polarizer carefully. Do not touch, push or rub the exposed polarizers with anything harder than an HB pencil lead (glass, tweezers, etc.). Do not put or attach anything on the display area to avoid leaving marks on. Condensation on the surface and contact with terminals due to cold will damage, stain or dirty the polarizer. After products are tested at low temperature they must be warmed up in a container before coming is contacting with room temperature air.

(5) If the display surface becomes contaminated, breathe on the surface and gently wipe it with a soft dry cloth. If it is heavily contaminated, moisten cloth with one of the following solvents

- Isopropyl alcohol
- Ethyl alcohol

Do not scrub hard to avoid damaging the display surface.

(6) Solvents other than those above-mentioned may damage the polarizer. Especially, do not use the following.

- Water
- Ketone
- Aromatic solvents

Wipe off saliva or water drops immediately, contact with water over a long period of time may cause deformation or color fading. Avoid contacting oil and fats.

(7) Exercise care to minimize corrosion of the electrode. Corrosion of the electrodes is accelerated by water droplets, moisture condensation or a current flow in a high-humidity environment.

(8) Install the LCD Module by using the mounting holes. When mounting the LCD module make sure it is free of twisting, warping and distortion. In particular, do not forcibly pull or bend the I/O cable or the backlight cable.

(9) Do not attempt to disassemble or process the LCD module.

(10) NC terminal should be open. Do not connect anything.

(11) If the logic circuit power is off, do not apply the input signals.

(12) Electro-Static Discharge Control, Since this module uses a CMOS LSI, the same careful attention should be paid to electrostatic discharge as for an ordinary CMOS IC. To prevent destruction of the elements by static electricity, be careful to maintain an optimum work environment.

- Before remove LCM from its packing case or incorporating it into a set, be sure the module and your body have the same electric potential. Be sure to ground the body when handling the LCD modules.

- Tools required for assembling, such as soldering irons, must be properly grounded. make certain the AC power source for the soldering iron does not leak. When using an electric screwdriver to attach LCM, the screwdriver should be of ground potentiality to minimize as much as possible any transmission of electromagnetic waves produced sparks coming from the commutator of the motor.

- To reduce the amount of static electricity generated, do not conduct assembling and other work under dry conditions. To reduce the generation of static electricity be careful that the air in the work is not too dried. A relative humidity of 50%-60% is recommended. As far as possible make the electric potential of your work clothes and that of the work bench the ground potential

- The LCD module is coated with a film to protect the display surface. Exercise care when peeling off this protective film since static electricity may be generated

(13) Since LCM has been assembled and adjusted with a high degree of precision, avoid applying excessive shocks to the module or making any alterations or modifications to it.

- Do not alter, modify or change the shape of the tab on the metal frame.
- Do not make extra holes on the printed circuit board, modify its shape or change the positions of components to be attached.
- Do not damage or modify the pattern writing on the printed circuit board.
- Absolutely do not modify the zebra rubber strip (conductive rubber) or heat seal connector.
- Except for soldering the interface, do not make any alterations or modifications with a soldering iron.
- Do not drop, bend or twist LCM.

Handling precaution for LCM

LCM is easy to be damaged.
Please note below and be careful for handling!

Correct handling:

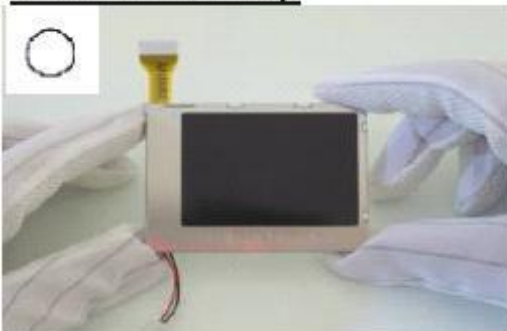

As above picture, please handle with anti-static gloves around LCM edges.

Incorrect handling:

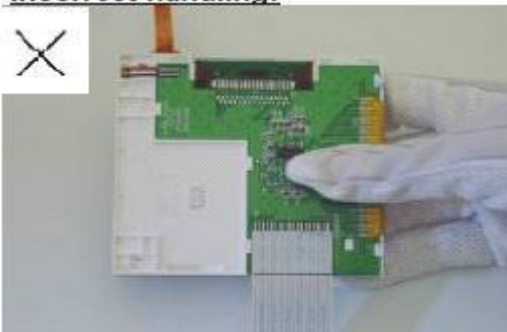

Please don't touch IC directly.

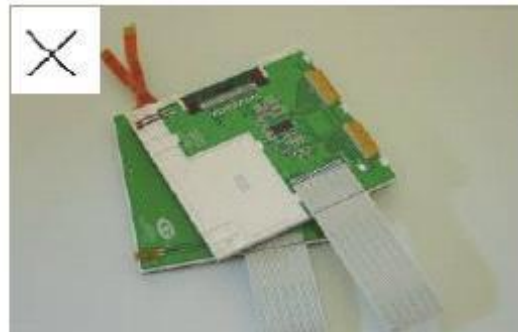

Please don't stack LCM.

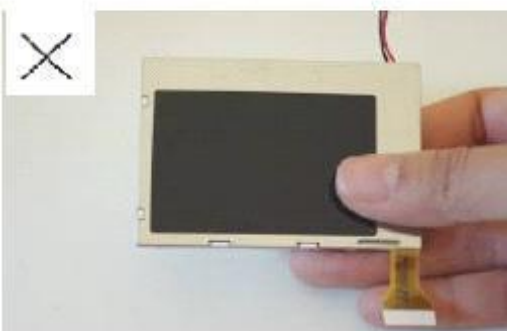

Please don't hold the surface of panel.

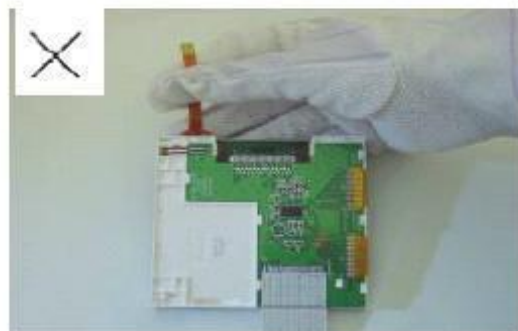

Please don't stretch interface of output, such as FPC cable.

Handling precaution for LCD

LCD is easy to be damaged.
Please note below and be careful for handling!

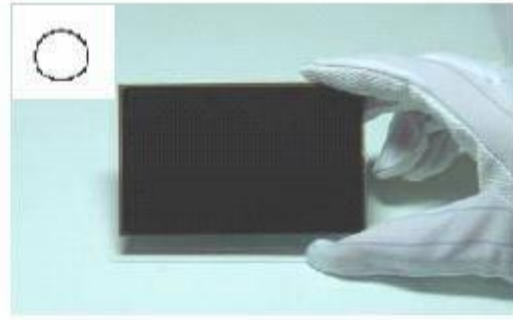
Correct handling:

As above photo, please handle with anti-static gloves around LCD edges.

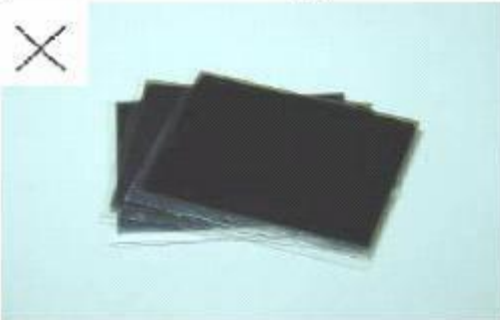
Incorrect handling:

Please don't stack the LCDS.

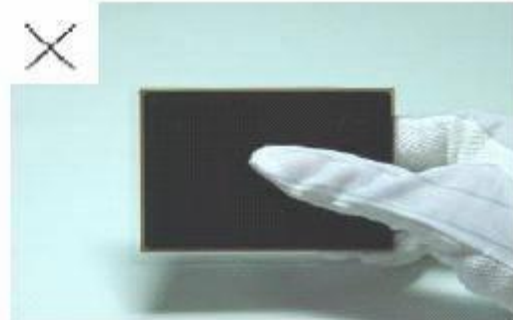

Please don't hold the surface of LCD.

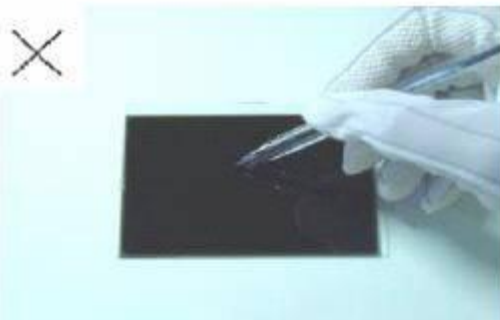

Please don't operate with sharp stick such as pens.

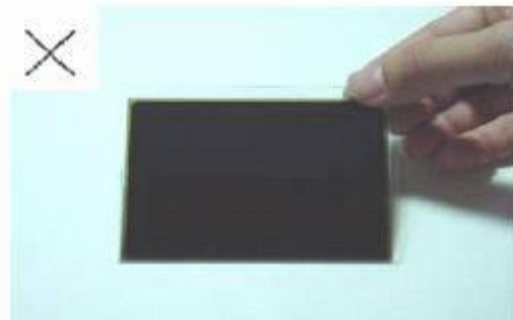

Please don't touch ITO glass without anti-static gloves.

Storage Precautions

When storing the LCD modules, the following precaution is necessary.

- (1) Store them in a sealed polyethylene bag. If properly sealed, there is no need for the dessicant.
- (2) Store them in a dark place. Do not expose to sunlight or fluorescent light, keep the temperature between 0°C and 35°C, and keep the relative humidity between 40%RH and 60%RH.
- (3) The polarizer surface should not come in contact with any other objects. (We advise you to store them in the anti-static electricity container in which they were shipped.

Others

Liquid crystals solidify under low temperature (below the storage temperature range) leading to defective orientation or the generation of air bubbles (black or white). Air bubbles may also be generated if the module is subject to a low temperature.

If the LCD modules have been operating for a long time showing the same display patterns, the display patterns may remain on the screen as ghost images and a slight contrast irregularity may also appear. A normal operating status can be regained by suspending use for some time. It should be noted that this phenomenon does not adversely affect performance reliability.

To minimize the performance degradation of the LCD modules resulting from destruction caused by static electricity etc., exercise care to avoid holding the following sections when handling the modules.

- Exposed area of the printed circuit board.
- Terminal electrode sections.

USING LCD MODULES

Installing LCD Modules

The hole in the printed circuit board is used to fix LCM as shown in the picture below. Attend to the following items when installing the LCM.

- (1) Cover the surface with a transparent protective plate to protect the polarizer and LC cell.

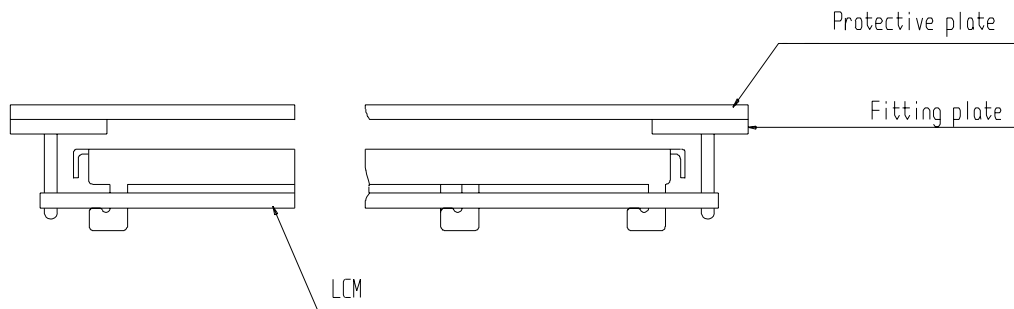

- (2) When assembling the LCM into other equipment, the spacer to the bit between the LCM and the fitting plate should have enough height to avoid causing stress to the module surface, refer to the individual specifications for measurements. The measurement tolerance should be ± 0.1 mm.

Precaution for assemble the module with BTB connector:

Please note the position of the male and female connector position, don't assemble or assemble like the method which the following picture shows

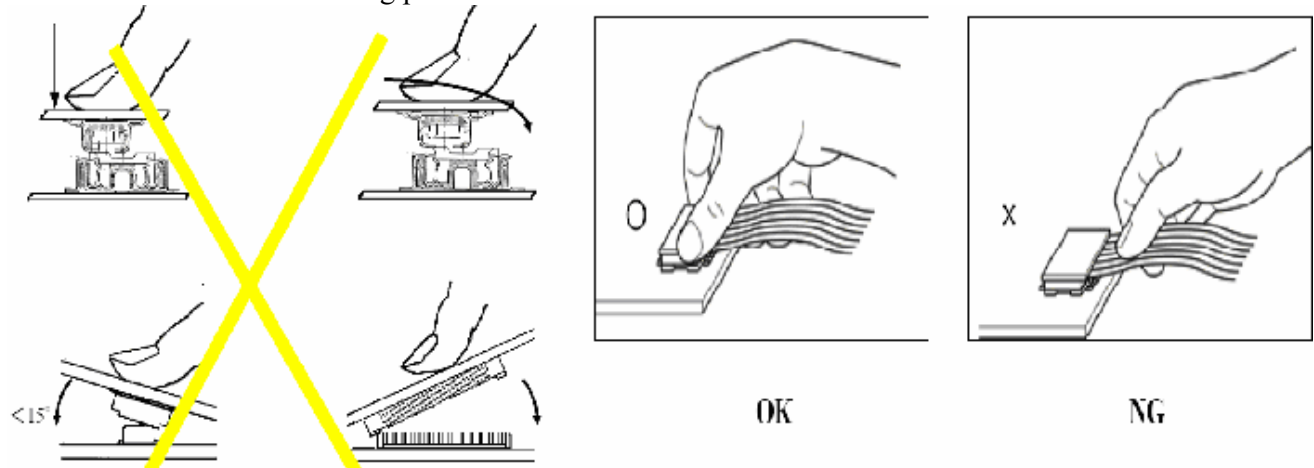

Precaution for soldering to the LCM

	Hand soldering	Machine drag soldering	Machine press soldering
No ROHS product	290°C ~350°C. Time : 3-5S.	330°C ~350°C. Speed : 4-8 mm/s.	300°C ~330°C. Time : 3-6S. Press: 0.8~1.2Mpa
ROHS product	340°C ~370°C. Time : 3-5S.	350°C ~370°C. Time : 4-8 mm/s.	330°C ~360°C. Time : 3-6S. Press: 0.8~1.2Mpa

(1) If soldering flux is used, be sure to remove any remaining flux after finishing to soldering operation. (This does not apply in the case of a non-halogen type of flux.) It is recommended that you protect the LCD surface with a cover during soldering to prevent any damage due to flux spatters.

(2) When soldering the electroluminescent panel and PC board, the panel and board should not be detached more than three times. This maximum number is determined by the temperature and time conditions mentioned above, though there may be some variance depending on the temperature of the soldering iron.

(3) When remove the electroluminescent panel from the PC board, be sure the solder has completely melted, the soldered pad on the PC board could be damaged.

Precautions for Operation

(1) Viewing angle varies with the change of liquid crystal driving voltage (VLCD). Adjust VLCD to show the best contrast.

(2) It is an indispensable condition to drive LCD's within the specified voltage limit since the higher voltage then the limit cause the shorter LCD life. An electrochemical reaction due to direct current causes LCD's undesirable deterioration, so that the use of direct current drive should be avoided.

(3) Response time will be extremely delayed at lower temperature than the operating temperature range and on the other hand at higher temperature LCD's show dark color in them. However those phenomena do not mean malfunction or out of order with LCD's, Which will come back in the specified operating temperature.

(4) If the display area is pushed hard during operation, the display will become abnormal. However, it will return to normal if it is turned off and then back on.

(5) A slight dew depositing on terminals is a cause for electro-chemical reaction resulting in terminal open circuit. Usage under the maximum operating temperature,50%RH or less is required.

(6) Input each signal after the positive/negative voltage becomes stable.

(7) Please keep the temperature within specified range for use and storage. Polarization degradation, bubble generation or polarizer peel-off may occur with high temperature and high humidity.

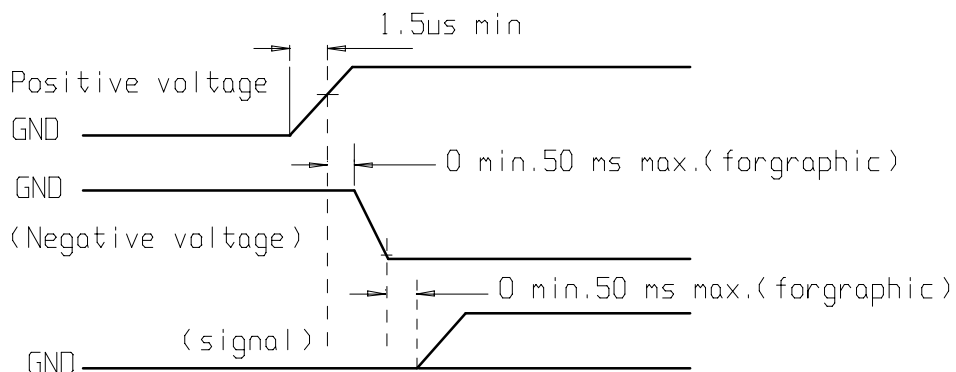

Safety

(1) It is recommended to crush damaged or unnecessary LCDs into pieces and wash them off with solvents such as acetone and ethanol, which should later be burned.

(2) If any liquid leaks out of a damaged glass cell and comes in contact with the hands, wash off thoroughly with soap and water.

Limited Warranty

Unless agreed between Multi-Inno and customer, Multi-Inno will replace or repair any of its LCD modules which are found to be functionally defective when inspected in accordance with Multi-Inno LCD acceptance standards (copies available upon request) for a period of one year from date of production. Cosmetic/visual defects must be returned to Multi-Inno within 90 days of shipment. Confirmation of such date shall be based on data code on product. The warranty liability of Multi-Inno limited to repair and/or replacement on the terms set forth above. Multi-Inno will not be responsible for any subsequent or consequential events.

Return LCM under warranty

No warranty can be granted if the precautions stated above have been disregarded. The typical examples of violations are :

- Broken LCD glass.
- PCB eyelet is damaged or modified.
- PCB conductors damaged.
- Circuit modified in any way, including addition of components.
- PCB tampered with by grinding, engraving or painting varnish.
- Soldering to or modifying the bezel in any manner.

Module repairs will be invoiced to the customer upon mutual agreement. Modules must be returned with sufficient description of the failures or defects. Any connectors or cable installed by the customer must be removed completely without damaging the PCB eyelet, conductors and terminals.

■ PRIOR CONSULT MATTER

- 1.①For Multi-Inno standard products, we keep the right to change material, process ... for improving the product property without notice on our customer.
②For OEM products, if any change needed which may affect the product property, we will consult with our customer in advance.
2. If you have special requirement about reliability condition, please let us know before you start the test on our samples.