



MULTI-INNO TECHNOLOGY CO., LTD.

www.multi-inno.com

LCD MODULE SPECIFICATION

Model : MI0570I2T-1

For Customer's Acceptance:

Customer	
Approved	
Comment	

Revision	1.0
Engineering	
Date	2010-05-20
Our Reference	



REVISION RECORD

REV NO.	REV DATE	CONTENTS	REMARKS
1.0	2010/05/20	Preliminary Specification	



CONTENTS

- GENERAL INFORMATION
- EXTERNAL DIMENSIONS
- ABSOLUTE MAXIMUM RATINGS
- ELECTRICAL CHARACTERISTICS
- ELECTRO-OPTICAL CHARACTERISTICS
- INTERFACE DESCRIPTION
- REFERENCE APPLICATION NOTES
- RELIABILITY TEST CONDITIONS
- INSPECTION CRITERION
- PRECAUTIONS FOR USING LCD MODULES
- PACKING SPECIFICATION
- PRIOR CONSULT MATTER

■ GENERAL INFORMATION

Item	Contents	Unit
LCD type	TFT/Transmissive/Normally white/Wide view	/
Size	5.7	Inch
Viewing direction	6:00	O' Clock
Gray scale inversion direction	12:00	O' Clock
LCM (W × H × D)	144.00×104.60×13.00	mm ³
Active area (W×H)	115.20×86.40	mm ²
Pixel size (W×H)	0.1815×0.1815	mm ²
Number of dots	640 (RGB) × 480	/
Driver IC	S:HX8250A,G:HX8678A	/
Backlight type	30 LEDs	/
Interface type	RGB 18 bits	/
Color depth	262K	/
Pixel configuration	R.G.B vertical stripe	/
Input voltage	3.3	V
With/Without TSP	Without TSP	/
Weight	154	g

Note 1:Viewing direction for best image quality is different from TFT definition, there is a 180 degree shift.

Note 2 : RoHS compliant;

Note 3: LCM weight tolerance: ± 5% .

EXTERNAL DIMENSIONS

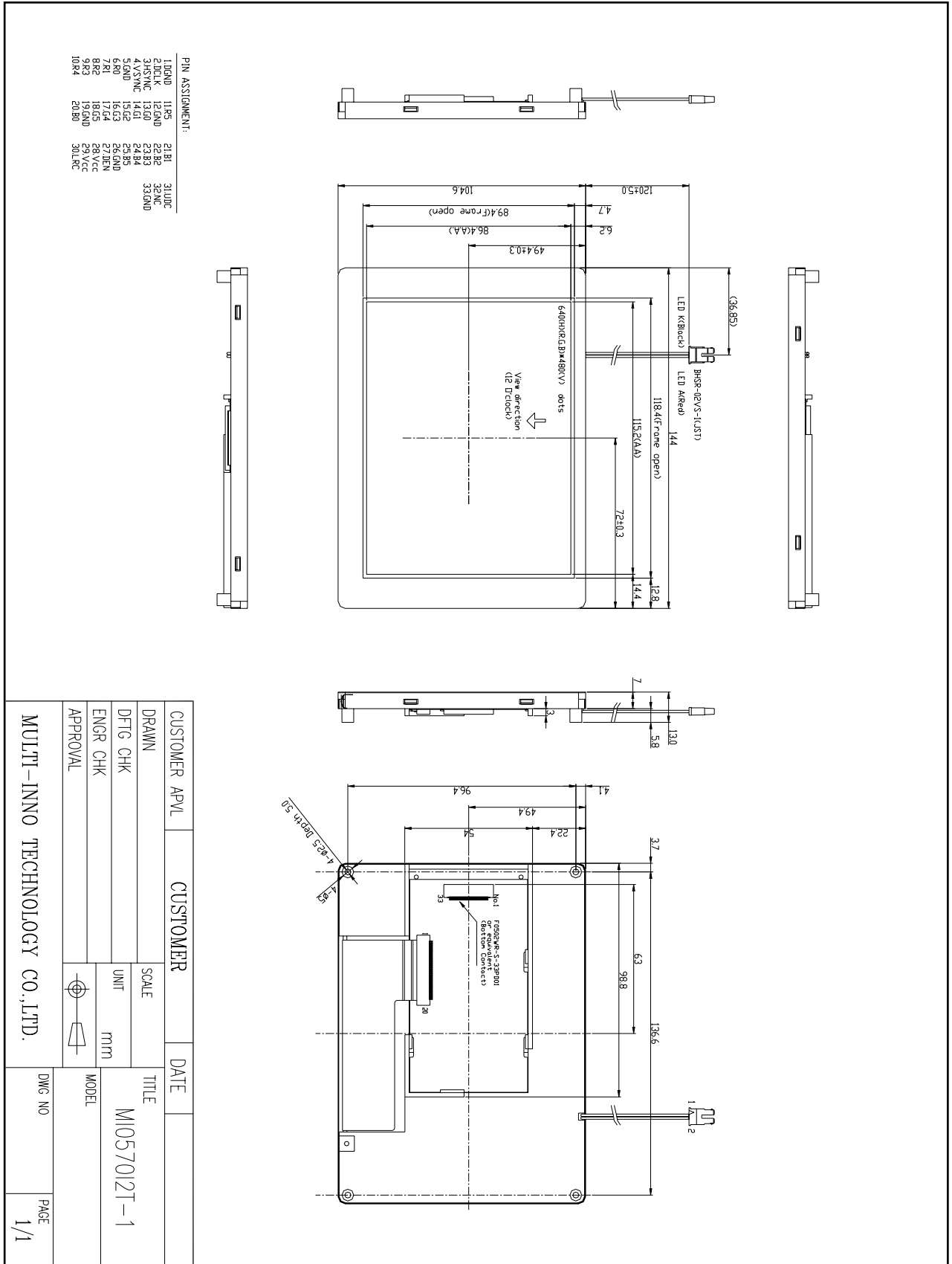

CUSTOMER APVL	CUSTOMER	DATE	
DRAWN	SCALE	TITLE	
DFTG CHK	UNIT	MI0570I2T-1	
ENGR CHK	MM	MODEL	
APPROVAL			
MULTI-INNO TECHNOLOGY CO.,LTD.		DWG NO	PAGE
			1/1

■ ABSOLUTE MAXIMUM RATINGS

Parameter of absolute maximum ratings	Symbol	Min	Max	Unit
Power supply voltage	VCC	-0.3	5.0	V
Input voltage	VIN	-0.3	V _{CC} +0.3	V
Permissible input ripple voltage	V _{RF}	-	100	mVp-p
Operating temperature	Top	-20	70	°C
Storage temperature	TST	-30	80	°C

Note (1) 95 % RH Max. (40 °C ≥ Ta). Maximum wet-bulb temperature at 39 °C or less. (Ta > 40 °C) No condensation.

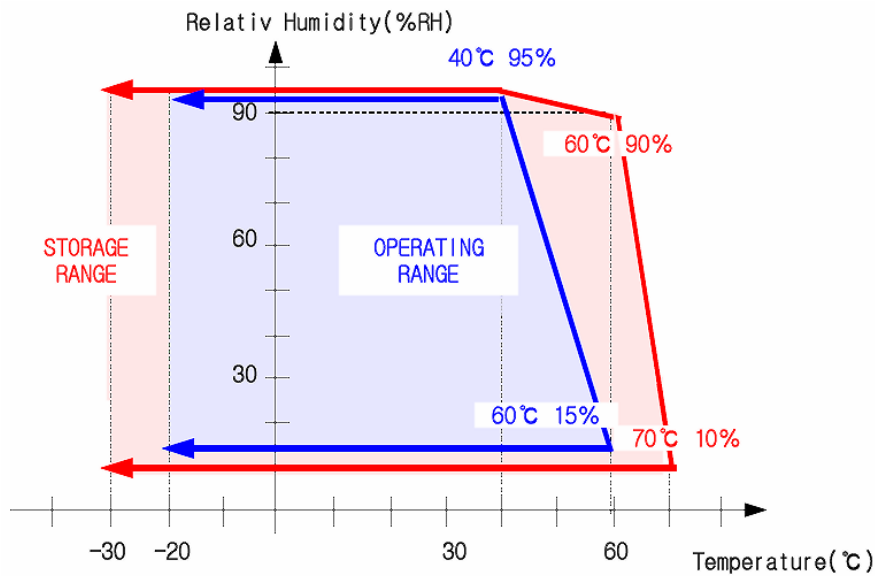

Note (2) In case of below 0°, the response time of liquid crystal (LC) becomes slower and the color of panel becomes darker than normal one. Level of retardation depends on temperature, because of LC's character

Note (3) Only operation is guaranteed at operating temperature. Contrast, response time, another display quality are evaluated at +25°C.

■ ELECTRICAL CHARACTERISTICS

DC CHARACTERISTICS

(Ta=25±2°C, V_{SS}=GND=0)

Item	Symbol	Min.	Typ.	Max.	Unit	Remark
Power supply	VCC	3.0	3.3	3.6	V	
Input Voltage for logic	H Level	V _{IH}	0.7xVDD	-	VDD	V
	L Level	V _{IL}	0	-	0.3xVDD	V
Power Supply current	ICC	-	120	-	mA	Note 1

Note1: Vcc-dip conditions
 Vcc-dip conditions should also follow the Vcc-turn-on conditions
 $T_d \leq 10ms$

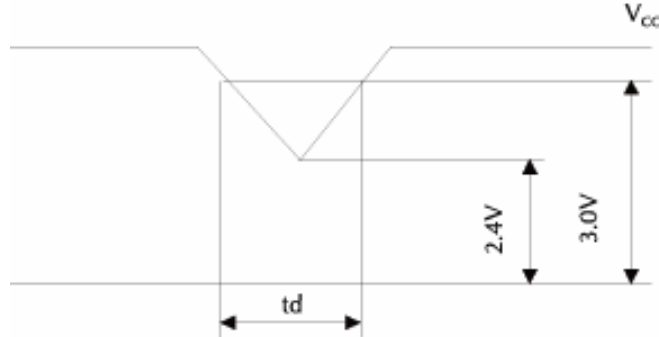

Note2: $f_v = 60Hz$, $T_a = 25^\circ C$, Display pattern : 64 Gray pattern

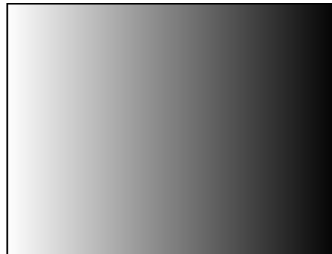

■ BACKLIGHT CHARACTERISTICS

The Back-light system is an edge-lighting type with 30 white LED(Light Emitting Diode)s. The characteristics of 30 white LEDs are shown in the following tables.

($T_a = \text{Room Temp}$)

Characteristics	Symbol	Min.	Typ.	Max.	Unit	Note
Current	I_B	-	200	-	mA	(1)
Voltage Forward	V_F	-	9.6	-	V	
Power Consumption	P_{BL}	-	1920	-	mW	(2)
LED Life Time	$25^\circ C$	-	30000	-	hr	(3)

Note (1) LEDs in 3 series x 10 parallel type.

(2) Where $I_B = 200mA$, $V_F = 9.6$, $P_{BL} = V_F \times I_B$

(3) The environmental conducted under ambient air flow ,at $T_a = 25 \pm 2^\circ C, 60\%RH \pm 5\%$

■ ELECTRO-OPTICAL CHARACTERISTICS

Item of electro-optical characteristics	Symbol	Condition	Min	Typ	Max	Unit	Remark	Note
Response time	Tr+ Tf	$\theta=0^\circ$ $\varnothing=0^\circ$ $T_a=25^\circ\text{C}$	-	40	55	ms	Fig.1	4
Contrastratio	Cr		300	450	-	---	FIG2.	1
Luminance uniformity	δ WHITE		70	80	-	%	FIG2.	3
Surface Luminance	Lv		800	900	-	cd/m ²	FIG 2.	2
Viewing angle range	θ	$\varnothing = 90^\circ$	40	50	-	deg	FIG3.	6
		$\varnothing = 270^\circ$	55	65	-	deg	FIG3.	
		$\varnothing = 0^\circ$	55	65	-	deg	FIG3.	
		$\varnothing = 180^\circ$	55	65	-	deg	FIG3.	
NTSC ratio	---	---	-	50	-	%	-	-
CIE (x, y) chromaticity	Red x	$\theta=0^\circ$ $\varnothing=0^\circ$ $T_a=25^\circ\text{C}$	0.585	0.615	0.645		FIG 2.	5
	Red y		0.314	0.344	0.374			
	Green x		0.277	0.307	0.337			
	Green y		0.532	0.562	0.592			
	Blue x		0.103	0.133	0.163			
	Blue y		0.120	0.150	0.180			
	White x		0.279	0.309	0.339			
	White y		0.320	0.350	0.380			

Note1. Contrast Ratio(CR) is defined mathematically by the following formula. For more information see FIG 2.:

$$\text{Contrast Ratio} = \frac{\text{Average Surface Luminance with all white pixels (P 1,P2, P 3,P4, P5)}}{\text{Average Surface Luminance with all black pixels (P1, P2, P 3,P4, P5)}}$$

Note2. Surface luminance is the LCD surface from the surface with all pixels displaying white. For more information see FIG 2.

$$L_v = \text{Average Surface Luminance with all white pixels (P1, P2, P 3,P4, P5)}$$

Note3. The uniformity in surface luminance (δ WHITE) is determined by measuring luminance at each test position 1 through 5, and then dividing the maximum luminance of 5 points luminance by minimum luminance of 5 points luminance. For more information see FIG 2.

$$\delta \text{ WHITE} = \frac{\text{Minimum Surface Luminance with all white pixels (P}_1, \text{P}_2, \text{P}_3, \text{P}_4, \text{P}_5)}{\text{Maximum Surface Luminance with all white pixels (P}_1, \text{P}_2, \text{P}_3, \text{P}_4, \text{P}_5)}$$

Note4. Response time is the time required for the display to transition from White to black(Rise Time, Tr) and from black to white(Decay Time, Tf). For additional information see FIG 1..

Note5. CIE (x, y) chromaticity ,The x,y value is determined by screen active area position 5. For more information see FIG 2.

Note6. Viewing angle is the angle at which the contrast ratio is greater than 2. For TFT module the contrast ratio is greater than 10. The angles are determined for the horizontal or x axis and the vertical or y axis with respect to the z axis which is normal to the LCD surface. For more information see FIG 3.

Note7. For Viewing angle and response time testing, the testing data is base on Autronic-Melchers's ConoScope. Series Instruments. For contrast ratio, Surface Luminance, Luminance uniformity and CIE, the testing data is base on TOPCON's BM-5 photo detector.

Note8. For TFT transmissive module, Gray scale reverse occurs in the direction of panel viewing angle.

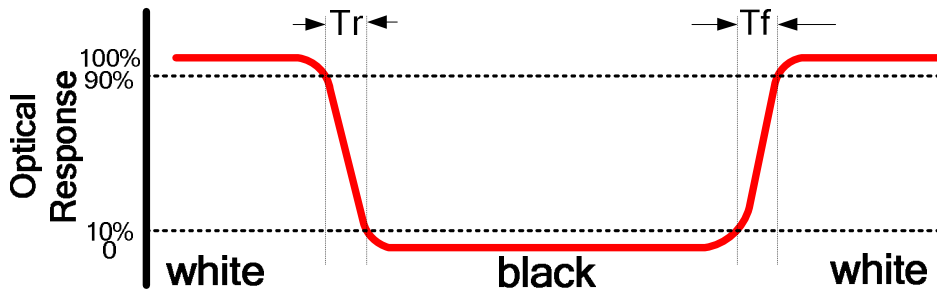
FIG.1. The definition of Response Time

FIG.2. Measuring method for Contrast ratio, surface luminance, Luminance uniformity, CIE (x, y) chromaticity

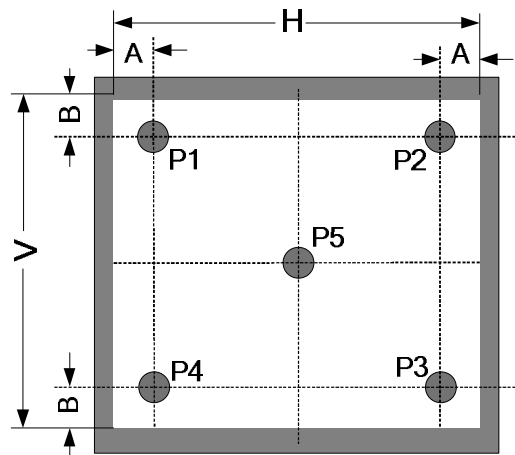
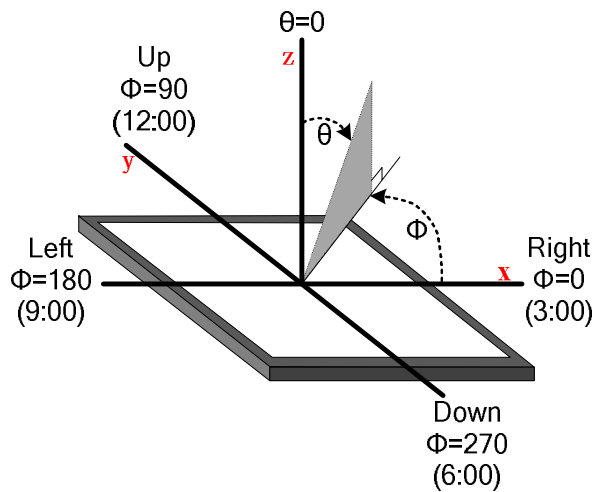
A : 5 mm
 B : 5 mm
 H, V : Active Area
 Light spot size $\varnothing=5\text{mm}$, 500mm distance from the LCD surface to detector lens
 measurement instrument is TOPCON's luminance meter BM-5

FIG.3. The definition of viewing angle

■ INTERFACE DESCRIPTION

1.1 Pin Assignment

Pin No.	Symbol	I/O	Function	Remark
1	DGND	--	GND	
2	DCLK	I	Clock signal for sampling each data signal	
3	Hsync	I	Horizontal synchronous signal (Negative)	
4	Vsync	I	Vertical synchronous signal (Negative)	
5	GND	I	GND	
6	R0	I	RED data signal (LSB)	
7	R1	I	RED data signal	
8	R2	I	RED data signal	
9	R3	I	RED data signal	
10	R4	I	RED data signal	
11	R5	I	RED data signal (MSB)	
12	GND	--	GND	
13	G0	I	GREEN data signal (LSB)	
14	G1	I	GREEN data signal	
15	G2	I	GREEN data signal	
16	G3	I	GREEN data signal	
17	G4	I	GREEN data signal	
18	G5	I	GREEN data signal (MSB)	
19	GND	--	GND	
20	B0	I	BLUE data signal(LSB)	
21	B1	I	BLUE data signal	
22	B2	I	BLUE data signal	
23	B3	I	BLUE data signal	
24	B4	I	BLUE data signal	
25	B5	I	BLUE data signal(MSB)	
26	GND	--	GND	
27	DEN	I	Signal to settle the horizontal display position (Positive)	
28	VCC	--	3.3V power supply	
29	VCC	--	3.3V power supply	
30	LRC	I	Horizontal display mode select signal H: Normal L: Left / Right reverse mode	
31	UDC	I	Vertical display mode select signal L: Normal H: Up / Down reverse mode	
32	NC	--	No Connection	
33	GND	I	GND	

Note 1 The horizontal display start timing is settled in accordance with a rising timing of ENAB signal. In case ENAB is fixed "Low", the horizontal start timing is determined. Don't keep ENAB "High" during operation.

1.2 Back Light Unit

Pin No.	Symbol	Function	Remark
1	LEDA	Power Supply for LED backlight	Red
2	LEDK	GND for LED backlight	Black

Connector: JST BHSR-02VS-1

■ REFERENCE APPLICATION NOTES

2.1 AC Timing Characteristic of The LCD

2.1.1 Timing Condition

Parameter	Symbol	Min.	Typ.	Max.	Unit.	Remark
CLK frequency	F_{CPH}	--	25.175	--	MHZ	
CLK period	T_{CPH}	--	39.7	--	ns	
CLK pulse duty	T_{CWH}	40	50	60	%	
HS period	T_H	--	800	--	T_{CPH}	
HS pulse width	T_{WH}	5	30	--	T_{CPH}	
HS-DEN time	T_{HS}	112	144	175	T_{CPH}	
DEN pulse width	T_{EP}	--	640	--	T_{CPH}	
VS pulse width	T_{WV}	1	3	5	T_H	
VS-DEN time	T_{STV}	--	35	--	T_H	
VS period	T_V	--	525	--	T_H	

 Note : When SYNC mode is used, 1st data start from 144th CLK after HS falling (when $STHD[5:0]=00000$)

Parameter	Symbol	Min.	Typ.	Max.	Unit.	Remark
OEV pulse width	T_{CVE}	--	100	--	T_{CPH}	
CKV pulse width	T_{CKV}	--	96	--	T_{CPH}	
HS-CKV time	T_1	--	52	--	T_{CPH}	
HS-OEV tim	T_2	--	8	--	T_{CPH}	
HS-POL time	T_3	--	72	--	T_{CPH}	
STV setup time	T_{SUV}	--	46	--	T_{CPH}	
STV pulse width	T_{WSTV}	--	1	--	T_H	

2.2 Clock and Data input waveforms

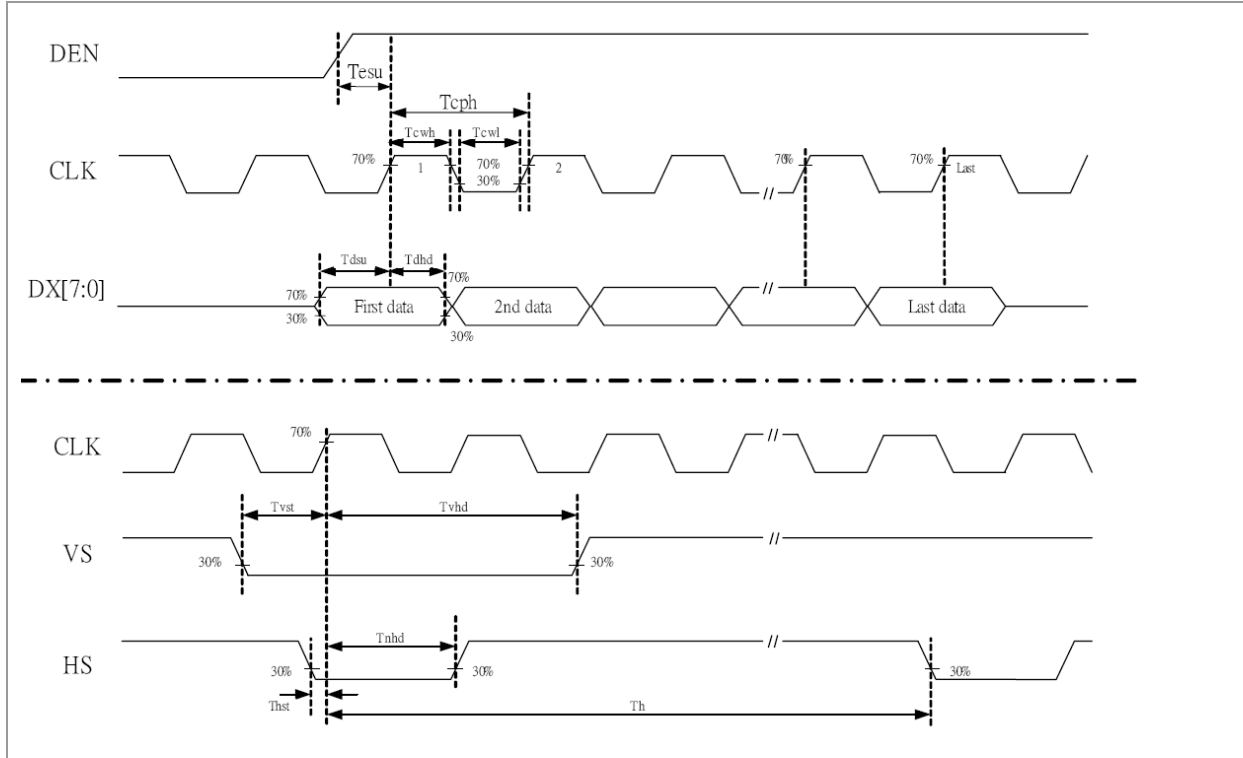

2.3 Data input format for parallel RGB Mode

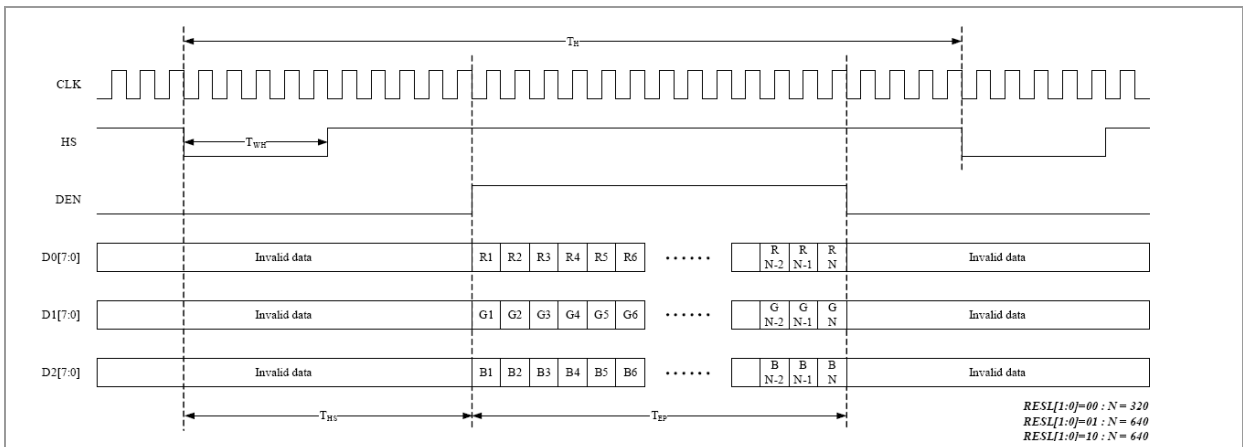

2.4 Digital RGB mode Horizontal timing for RESL[1:0]=10

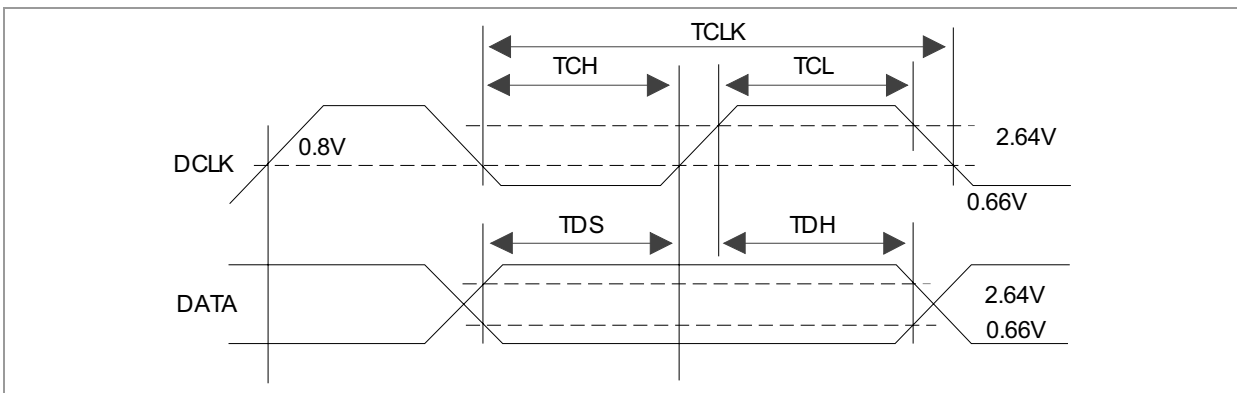
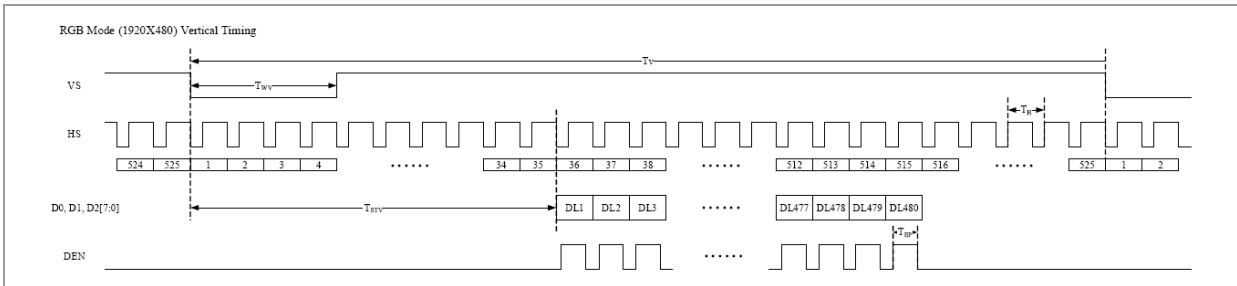

2.5 Display On/Off Sequence :

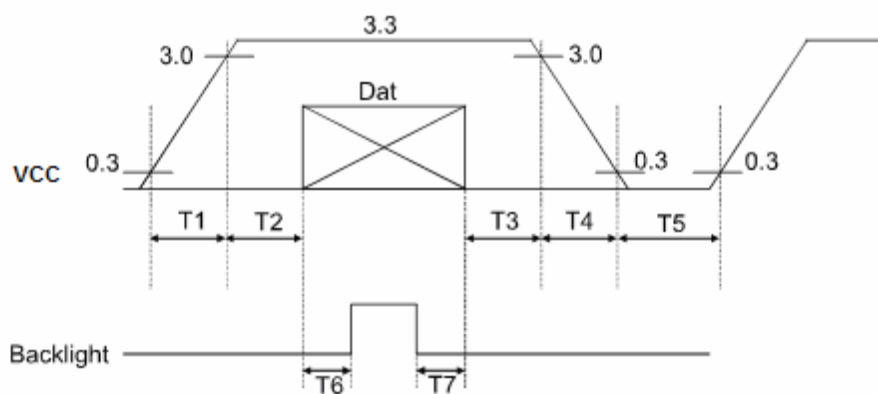

Data: DCLK, R0 ~ R5, G0 ~ G5, B0 ~ B5, DE

$T1 \leq 10ms$, $50ms \leq T2$, $0 < T3 \leq 50ms$, $0 < T4 \leq 10ms$, $1s \leq T5$, $200ms \leq T6$, $200ms \leq T7$

3. Displayed Color and Input Data

	Color & Gray Scale	Data Signal																	
		R5	R4	R3	R2	R1	R0	G5	G4	G3	G2	G1	G0	B5	B4	B3	B2	B1	B0
Basic Color	Black	0	0	0	0	0	0	0	0	0	0	0	0	0	0	0	0	0	0
	Red(0)	1	1	1	1	1	1	0	0	0	0	0	0	0	0	0	0	0	0
	Green(0)	0	0	0	0	0	0	1	1	1	1	1	1	0	0	0	0	0	0
	Blue(0)	0	0	0	0	0	0	0	0	0	0	0	0	1	1	1	1	1	1
	Cyan	0	0	0	0	0	0	1	1	1	1	1	1	1	1	1	1	1	1
	Magenta	1	1	1	1	1	1	0	0	0	0	0	0	1	1	1	1	1	1
	Yellow	1	1	1	1	1	1	1	1	1	1	1	1	0	0	0	0	0	0
	White	1	1	1	1	1	1	1	1	1	1	1	1	1	1	1	1	1	1
Red	Black	0	0	0	0	0	0	0	0	0	0	0	0	0	0	0	0	0	0
	Red(1)	0	0	0	0	0	1	0	0	0	0	0	0	0	0	0	0	0	0
	Red(2)	0	0	0	0	1	0	0	0	0	0	0	0	0	0	0	0	0	0
	:	:	:	:	:	:	:	:	:	:	:	:	:	:	:	:	:	:	:
	Red(31)	1	1	1	1	1	1	0	0	0	0	0	0	0	0	0	0	0	0
	:	:	:	:	:	:	:	:	:	:	:	:	:	:	:	:	:	:	:
	Red(62)	1	1	1	1	1	0	0	0	0	0	0	0	0	0	0	0	0	0
	Red(63)	1	1	1	1	1	1	0	0	0	0	0	0	0	0	0	0	0	0
Green	Black	0	0	0	0	0	0	0	0	0	0	0	0	0	0	0	0	0	0
	Green(1)	0	0	0	0	0	0	0	0	0	0	0	1	0	0	0	0	0	0
	Green(2)	0	0	0	0	0	0	0	0	0	0	1	0	0	0	0	0	0	0
	:	:	:	:	:	:	:	:	:	:	:	:	:	:	:	:	:	:	:
	Green(31)	0	0	0	0	0	0	1	1	1	1	1	1	0	0	0	0	0	0
	:	:	:	:	:	:	:	:	:	:	:	:	:	:	:	:	:	:	:
	Green(62)	0	0	0	0	0	0	1	1	1	1	1	0	0	0	0	0	0	0
	Green(63)	0	0	0	0	0	0	1	1	1	1	1	1	0	0	0	0	0	0
Blue	Black	0	0	0	0	0	0	0	0	0	0	0	0	0	0	0	0	0	0
	Blue(1)	0	0	0	0	0	0	0	0	0	0	0	0	0	0	0	0	0	1
	Blue(2)	0	0	0	0	0	0	0	0	0	0	0	0	0	0	0	0	1	0
	:	:	:	:	:	:	:	:	:	:	:	:	:	:	:	:	:	:	:
	Blue(31)	0	0	0	0	0	0	0	0	0	0	0	0	1	1	1	1	1	1
	:	:	:	:	:	:	:	:	:	:	:	:	:	:	:	:	:	:	:
	Blue(62)	0	0	0	0	0	0	0	0	0	0	0	0	1	1	1	1	1	0
	Blue(63)	0	0	0	0	0	0	0	0	0	0	0	0	1	1	1	1	1	1

0 : Low level voltage, 1 :High level voltage

Each basic color can be displayed in 64 gray scales from 6 bit data signals. With the combination of total 18 bit data signals, the 262,144-color display can be achieved on the screen.

■ RELIABILITY TEST CONDITIONS

No.	Test Item	Test Condition	Inspection after test
1	High Temperature Storage	$80 \pm 2^{\circ}\text{C}/240$ hours	
2	Low Temperature Storage	$-30 \pm 2^{\circ}\text{C}/240$ hours	
3	High Temperature Operating	$70 \pm 2^{\circ}\text{C}/240$ hours	
4	Low Temperature Operating	$-20 \pm 2^{\circ}\text{C}/240$ hours	
5	Damp proof Test operating	$60^{\circ}\text{C} \pm 5^{\circ}\text{C} \times 90\% \text{RH}/240$ hours	
6	Vibration test	Vibration Frequency:10~55Hz. Total fixed amplitude:1.5mm. One cycle 60 seconds to 3 direction of X, Y, Z each 15 minutes.	
7	Dropping test	To be measured after dropping from 60cm high on the concrete surface in packing state.	

■ INSPECTION CRITERION

This specification is made to be used as the standard acceptance/rejection criteria for Normal LCM Product.

1 Sample plan

Sampling plan according to GB/T2828.1-2003/ISO 2859-1: 1999 and ANSI/ASQC Z1.4-1993, normal level 2 and based on:

Major defect: AQL 0.65

Minor defect: AQL 1.5

2. Inspection condition

- Viewing distance for cosmetic inspection is about 30cm with bare eyes, and under an environment of 20~40W light intensity, all directions for inspecting the sample should be within 45° against perpendicular line. (Normal temperature 20~25°C and normal humidity 60±15%RH).

- Driving voltage

The Vop value from which the most optimal contrast can be obtained near the specified Vop in the specification (Within ±0.5V of the typical value at 25°C.).

3. Definition of inspection zone in LCD.

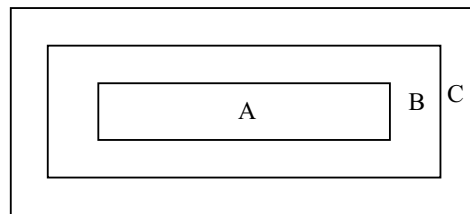

Zone A: character/Digit area

Zone B: viewing area except Zone A (ZoneA+ZoneB=minimum Viewing area)

Zone C: Outside viewing area (invisible area after assembly in customer's product)

Fig.1 Inspection zones in an LCD.

Note: As a general rule, visual defects in Zone C are permissible, when it is no trouble for quality and assembly of customer's product.

4. Inspection Standard

4.1 Major Defect

Item No	Items to be inspected	Inspection Standard	Classification of defects
4.1.1	All functional defects	1) No display 2) Display abnormally 3) Missing vertical, horizontal segment 4) Short circuit 5) Back-light no lighting, flickering and abnormal lighting.	Major
4.1.2	Missing	Missing component	
4.1.3	Outline dimension	Overall outline dimension beyond the drawing is not allowed.	

4.2 Cosmetic Defect

4.2.1 Module Cosmetic Criteria

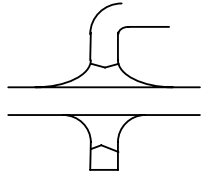
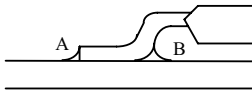
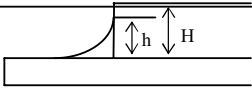
No.	Item	Judgement Criterion	Partition
1	Difference in Spec.	None allowed	Major
2	Pattern peeling	No substrate pattern peeling and floating	Major
3	Soldering defects	No soldering missing No soldering bridge No cold soldering	Major Major Minor
4	Resist flaw on Printed Circuit Boards	visible copper foil ($\varnothing 0.5\text{mm}$ or more) on substrate pattern	Minor
5	Accretion of metallic Foreign matter	No accretion of metallic foreign matters (Not exceed $\varnothing 0.2\text{mm}$)	Minor Minor
6	Stain	No stain to spoil cosmetic badly	Minor
7	Plate discoloring	No plate fading, rusting and discoloring	Minor
8	Solder amount	a. Soldering side of PCB Solder to form a 'Filet' all around the lead. Solder should not hide the lead form perfectly. (too much) b. Components side (In case of 'Through Hole PCB')  Solder to reach the Components side of PCB.	Minor
	1. Lead parts		
	2. Flat packages	Either 'Toe' (A) or 'Seal' (B) of the lead to be covered by 'Filet'.  Lead form to be assume over solder.	Minor
	3. Chips	$(3/2) H \geq h \geq (1/2) H$ 	Minor

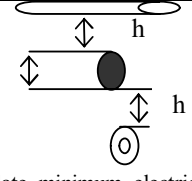
9	Solder splash	ball/Solder	a. The spacing between solder ball and the conductor or solder pad $h \geq 0.13\text{mm}$ The diameter of solder ball $d \leq 0.15\text{mm}$.		Minor
			b. The quantity of solder balls or solder Splashes isn't beyond 5 in 600mm^2 .		Minor
			c. Solder balls/Solder splashes do not violate minimum electrical clearance.		Major
			d. Solder balls/Solder splashes must be entrapped/encapsulated Or attached to the metal surface.		Minor
			NOTE: Entrapped/encapsulated/attached is intended to mean that normal service environment of the product will not cause a solder ball to become dislodged.		

4.2.2 Cosmetic Criteria (Non-Operating)

No.	Defect	Judgment Criterion	Partition										
1	Spots	In accordance with <i>Screen Cosmetic Criteria (Operating) No.1.</i>	Minor										
2	Lines	In accordance with <i>Screen Cosmetic Criteria (Operating) No.2.</i>	Minor										
3	Bubbles in polarizer	<table border="1" style="width: 100%; border-collapse: collapse;"> <thead> <tr> <th>Size : d mm</th> <th>Acceptable Qty in active area</th> </tr> </thead> <tbody> <tr> <td>$d \leq 0.3$</td> <td>Disregard</td> </tr> <tr> <td>$0.3 < d \leq 1.0$</td> <td>3</td> </tr> <tr> <td>$1.0 < d \leq 1.5$</td> <td>1</td> </tr> <tr> <td>$1.5 < d$</td> <td>0</td> </tr> </tbody> </table>	Size : d mm	Acceptable Qty in active area	$d \leq 0.3$	Disregard	$0.3 < d \leq 1.0$	3	$1.0 < d \leq 1.5$	1	$1.5 < d$	0	Minor
Size : d mm	Acceptable Qty in active area												
$d \leq 0.3$	Disregard												
$0.3 < d \leq 1.0$	3												
$1.0 < d \leq 1.5$	1												
$1.5 < d$	0												
4	Scratch	In accordance with spots and lines operating cosmetic criteria. When the light reflects on the panel surface, the scratches are not to be remarkable.	Minor										
5	Allowable density	Above defects should be separated more than 30mm each other.	Minor										
6	Coloration	Not to be noticeable coloration in the viewing area of the LCD panels. Back-lit type should be judged with back-lit on state only.	Minor										
7	Contamination	Not to be noticeable.	Minor										

4.2.3 Cosmetic Criteria (Operating)

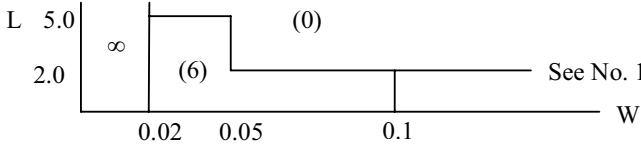
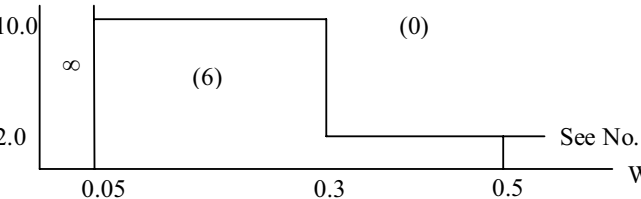
No.	Defect	Judgment Criterion	Partition																																												
1	Spots	<p>A) Clear</p> <table border="1" data-bbox="480 461 1233 763"> <thead> <tr> <th>Lcd size</th> <th>Size : d mm</th> <th>Acceptable Qty in active area</th> </tr> </thead> <tbody> <tr> <td rowspan="4">Lcd size ≤ 8.0'</td> <td>d ≤ 0.1</td> <td>Disregard</td> </tr> <tr> <td>0.1 < d ≤ 0.2</td> <td>6</td> </tr> <tr> <td>0.2 < d ≤ 0.3</td> <td>2</td> </tr> <tr> <td>0.3 < d</td> <td>0</td> </tr> <tr> <td rowspan="4">Lcd size > 8.0'</td> <td>d ≤ 0.1</td> <td>Disregard</td> </tr> <tr> <td>0.1 < d ≤ 0.3</td> <td>10</td> </tr> <tr> <td>0.3 < d ≤ 0.5</td> <td>5</td> </tr> <tr> <td>0.5 < d</td> <td>0</td> </tr> </tbody> </table> <p>Note : Including pin holes and defective dots which must be within one pixel size; Total defective point shall not exceed 6 pcs no more than 8 inch LCD and 10PCS for more than 8 inch LCD.</p> <p>B) Unclear</p> <table border="1" data-bbox="491 927 1241 1272"> <thead> <tr> <th>Lcd size</th> <th>Size : d mm</th> <th>Acceptable Qty in active area</th> </tr> </thead> <tbody> <tr> <td rowspan="4">Lcd size ≤ 8.0'</td> <td>d ≤ 0.2</td> <td>Disregard</td> </tr> <tr> <td>0.2 < d ≤ 0.5</td> <td>6</td> </tr> <tr> <td>0.5 < d ≤ 0.7</td> <td>2</td> </tr> <tr> <td>0.7 < d</td> <td>0</td> </tr> <tr> <td rowspan="5">Lcd size > 8.0'</td> <td>d ≤ 0.2</td> <td>Disregard</td> </tr> <tr> <td>0.2 < d ≤ 0.5</td> <td>10</td> </tr> <tr> <td>0.5 < d ≤ 0.7</td> <td>3</td> </tr> <tr> <td>0.7 < d ≤ 1.0</td> <td>1</td> </tr> <tr> <td>1.0 < d</td> <td>0</td> </tr> </tbody> </table> <p>Note : Total defective point shall not exceed 6 pcs for no more than 8 inch LCD and 10PCS for more than 8 inch LCD.</p>	Lcd size	Size : d mm	Acceptable Qty in active area	Lcd size ≤ 8.0'	d ≤ 0.1	Disregard	0.1 < d ≤ 0.2	6	0.2 < d ≤ 0.3	2	0.3 < d	0	Lcd size > 8.0'	d ≤ 0.1	Disregard	0.1 < d ≤ 0.3	10	0.3 < d ≤ 0.5	5	0.5 < d	0	Lcd size	Size : d mm	Acceptable Qty in active area	Lcd size ≤ 8.0'	d ≤ 0.2	Disregard	0.2 < d ≤ 0.5	6	0.5 < d ≤ 0.7	2	0.7 < d	0	Lcd size > 8.0'	d ≤ 0.2	Disregard	0.2 < d ≤ 0.5	10	0.5 < d ≤ 0.7	3	0.7 < d ≤ 1.0	1	1.0 < d	0	Minor
Lcd size	Size : d mm	Acceptable Qty in active area																																													
Lcd size ≤ 8.0'	d ≤ 0.1	Disregard																																													
	0.1 < d ≤ 0.2	6																																													
	0.2 < d ≤ 0.3	2																																													
	0.3 < d	0																																													
Lcd size > 8.0'	d ≤ 0.1	Disregard																																													
	0.1 < d ≤ 0.3	10																																													
	0.3 < d ≤ 0.5	5																																													
	0.5 < d	0																																													
Lcd size	Size : d mm	Acceptable Qty in active area																																													
Lcd size ≤ 8.0'	d ≤ 0.2	Disregard																																													
	0.2 < d ≤ 0.5	6																																													
	0.5 < d ≤ 0.7	2																																													
	0.7 < d	0																																													
Lcd size > 8.0'	d ≤ 0.2	Disregard																																													
	0.2 < d ≤ 0.5	10																																													
	0.5 < d ≤ 0.7	3																																													
	0.7 < d ≤ 1.0	1																																													
	1.0 < d	0																																													
2	Lines	<p>A) Clear</p>  <p>Note : () - Acceptable Qty in active area L - Length (mm) W - Width (mm) ∞ - Disregard</p> <p>B) Unclear</p>  <p>‘Clear’ = the shade and size of the line or dot are not changed with the LCD operation voltage changing .the defect looks very apparent. ‘Unclear’ = the shade and size of the line or dot are changed with the LCD operation voltage changing ,the defect looks not so apparent</p>	Minor																																												

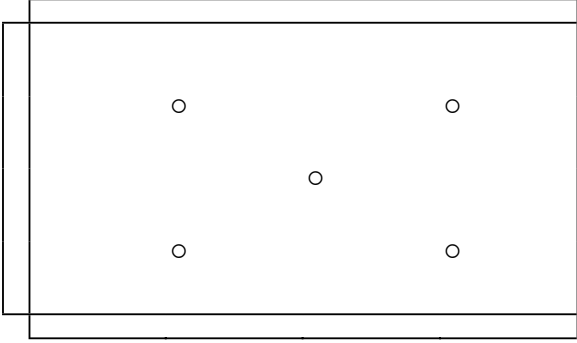
3	Rubbing line	Not to be noticeable.	Minor
4	Allowable density	Above defects should be separated more than 10mm each other.	Minor
5	Rainbow	Not to be noticeable.	Minor
6	Dot size	To be 95% ~ 105% of the dot size (Typ.) in drawing. Partial defects of each dot (ex. pin-hole) should be treated as 'Spot'. (see <i>Screen Cosmetic Criteria (Operating) No.1</i>)	Minor
7	Uneven brightness (only back-lit type module)	<p>Uneven brightness must be $B_{MAX} / B_{MIN} \leq 2$</p> <ul style="list-style-type: none"> - B_{MAX} : Max. value by measure in 5 points - B_{MIN} : Min. value by measure in 5 points <p>Divide active area into 4 vertically and horizontally. Measure 5 points shown in the following figure.</p>  <p style="text-align: center;">○ : Measuring points</p>	Minor

Note :

- (1) Size : $d = (\text{long length} + \text{short length}) / 2$
- (2) The limit samples for each item have priority.
- (3) Complex defects are defined item by item, but if the numbers of defects are defined in above table, the total number should not exceed 10.
- (4) In case of 'concentration', even the spots or the lines of 'disregarded' size should not allowed. Following three situations should be treated as 'concentration'.
 - 7 or over defects in circle of $\varnothing 5\text{mm}$.
 - 10 or over defects in circle of $\varnothing 10\text{mm}$.
 - 20 or over defects in circle of $\varnothing 20\text{mm}$.

■ PRECAUTIONS FOR USING LCD MODULES

1 Handling Precautions

- 1.1 The display panel is made of glass and polarizer. As glass is fragile. It tends to become or chipped during handling especially on the edges. Please avoid dropping or jarring. Do not subject it to a mechanical shock by dropping it or impact.
- 1.2 If the display panel is damaged and the liquid crystal substance leaks out, be sure not to get any in your mouth. If the substance contacts your skin or clothes, wash it off using soap and water.
- 1.3 Do not apply excessive force to the display surface or the adjoining areas since this may cause the color tone to vary. Do not touch the display with bare hands. This will stain the display area and degraded insulation between terminals (some cosmetics are determined to the polarizer).
- 1.4 The polarizer covering the display surface of the LCD module is soft and easily scratched. Handle this polarizer carefully. Do not touch, push or rub the exposed polarizers with anything harder than an HB pencil lead (glass, tweezers, etc.). Do not put or attach anything on the display area to avoid leaving marks on it. Condensation on the surface and contact with terminals due to cold will damage, stain or dirty the polarizer. After products are tested at low temperature they must be warmed up in a container before coming in to contact with room temperature air.
- 1.5 If the display surface becomes contaminated, breathe on the surface and gently wipe it with a soft dry cloth. If it is heavily contaminated, moisten cloth with one of the following solvents
 - Isopropyl alcohol
 - Ethyl alcoholDo not scrub hard to avoid damaging the display surface.
- 1.6 Solvents other than those above-mentioned may damage the polarizer. Especially, do not use the following.
 - Water
 - Ketone
 - Aromatic solventsWipe off saliva or water drops immediately, contact with water over a long period of time may cause deformation or color fading. Avoid contact with oil and fats.
- 1.7 Exercise care to minimize corrosion of the electrode. Corrosion of the electrodes is accelerated by water droplets, moisture condensation or a current flow in a high-humidity environment.
- 1.8 Install the LCD Module by using the mounting holes. When mounting the LCD module make sure it is free of twisting, warping and distortion. In particular, do not forcibly pull or bend the I/O cable or the backlight cable.
- 1.9 Do not attempt to disassemble or process the LCD module.
- 1.10 NC terminal should be open. Do not connect anything.
- 1.11 If the logic circuit power is off, do not apply the input signals.
- 1.12 Electro-Static Discharge Control, Since this module uses a CMOS LSI, the same careful attention should be paid to electrostatic discharge as for an ordinary CMOS IC. To prevent destruction of the elements by static electricity, be careful to maintain an optimum work environment.
 - Before removing LCM from its packing case or incorporating it into a set, be sure the module and your body have the same electric potential. Be sure to ground the body when handling the LCD modules.
 - Tools required for assembling, such as soldering irons, must be properly grounded. Make certain the AC power source for the soldering iron does not leak. When using an electric screwdriver to attach LCM, the screwdriver should be of ground potentiality to minimize as much as possible any transmission of electromagnetic waves produced sparks coming from the commutator of the motor.
 - To reduce the amount of static electricity generated, do not conduct assembling

and other work under dry conditions. To reduce the generation of static electricity be careful that the air in the work is not too dry. A relative humidity of 50%-60% is recommended. As far as possible make the electric potential of your work clothes and that of the work bench the ground potential.

- The LCD module is coated with a film to protect the display surface. Exercise care when peeling off this protective film since static electricity may be generated.

1.13 Since LCM has been assembled and adjusted with a high degree of precision, avoid applying excessive shocks to the module or making any alterations or modifications to it.

- Do not alter, modify or change the shape of the tab on the metal frame.
- Do not make extra holes on the printed circuit board, modify its shape or change the positions of components to be attached.
- Do not damage or modify the pattern writing on the printed circuit board.
- Absolutely do not modify the zebra rubber strip (conductive rubber) or heat seal connector.
- Except for soldering the interface, do not make any alterations or modifications with a soldering iron.
- Do not drop, bend or twist the LCM.

2 Handling precaution for LCM

2.1 LCM is easy to be damaged. Please note below and be careful for handling.

2.2 Correct handling:

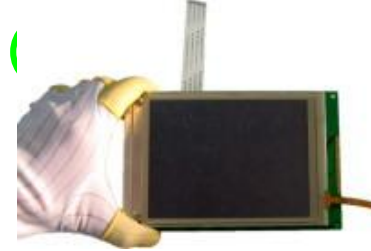

As above picture, please handle with anti-static gloves around LCM edges.

2.3 Incorrect handling:

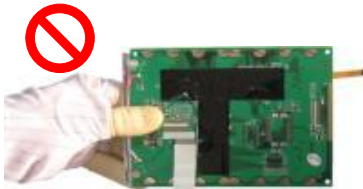

Please don't touch IC directly.

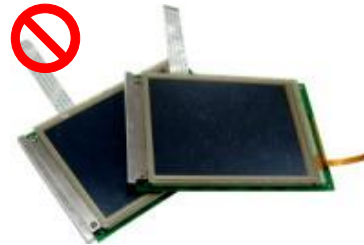

Please don't stack LCM.



Please don't hold the surface of panel.



Please don't stretch interface of output, such as FPC cable.

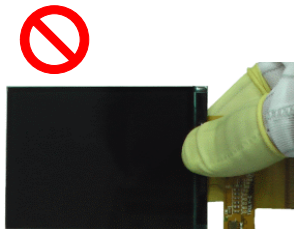

Please don't hold the surface of IC.

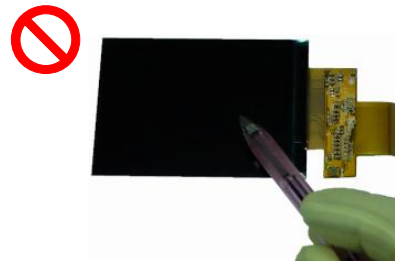

Please don't operate with sharp stick such as pens.

3 Storage Precautions

- 3.1 When storing the LCD modules, the following precaution are necessary.
 - 3.1.1 Store them in a sealed polyethylene bag. If properly sealed, there is no need for the desiccant.
 - 3.1.2 Store them in a dark place. Do not expose to sunlight or fluorescent light, keep the temperature between 0°C and 35°C, and keep the relative humidity between 40%RH and 60%RH.
 - 3.1.3 The polarizer surface should not come in contact with any other objects (We advise you to store them in the anti-static electricity container in which they were shipped).
- 3.2 Others
 - 3.2.1 Liquid crystals solidify under low temperature (below the storage temperature range) leading to defective orientation or the generation of air bubbles (black or white). Air bubbles may also be generated if the module is subject to a low temperature.
 - 3.2.2 If the LCD modules have been operating for a long time showing the same display patterns, the display patterns may remain on the screen as ghost images and a slight contrast irregularity may also appear. A normal operating status can be regained by suspending use for some time. It should be noted that this phenomenon does not adversely affect performance reliability.
 - 3.2.3 To minimize the performance degradation of the LCD modules resulting from destruction caused by static electricity etc., exercise care to avoid holding the following sections when handling the modules.
 - 3.2.3.1 - Exposed area of the printed circuit board.
 - 3.2.3.2 -Terminal electrode sections.

4 USING LCD MODULES

4.1 Installing LCD Modules

The hole in the printed circuit board is used to fix LCM as shown in the picture below.

Attend to the following items when installing the LCM.

- 4.1.1 Cover the surface with a transparent protective plate to protect the polarizer and LC cell.

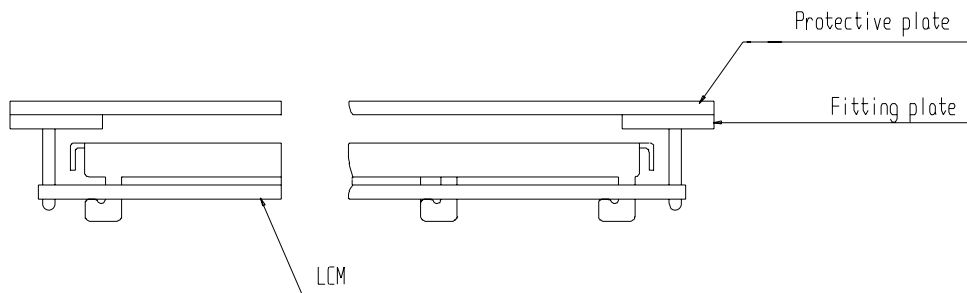

- 4.1.2 When assembling the LCM into other equipment, the spacer to the bit between the LCM and the fitting plate should have enough height to avoid causing stress to the module surface, refer to the individual specifications for measurements. The measurement tolerance should be ± 0.1 mm.

4.2 Precaution for assemble the module with BTB connector:

Please note the position of the male and female connector position, don't assemble or assemble like the method which the following picture shows

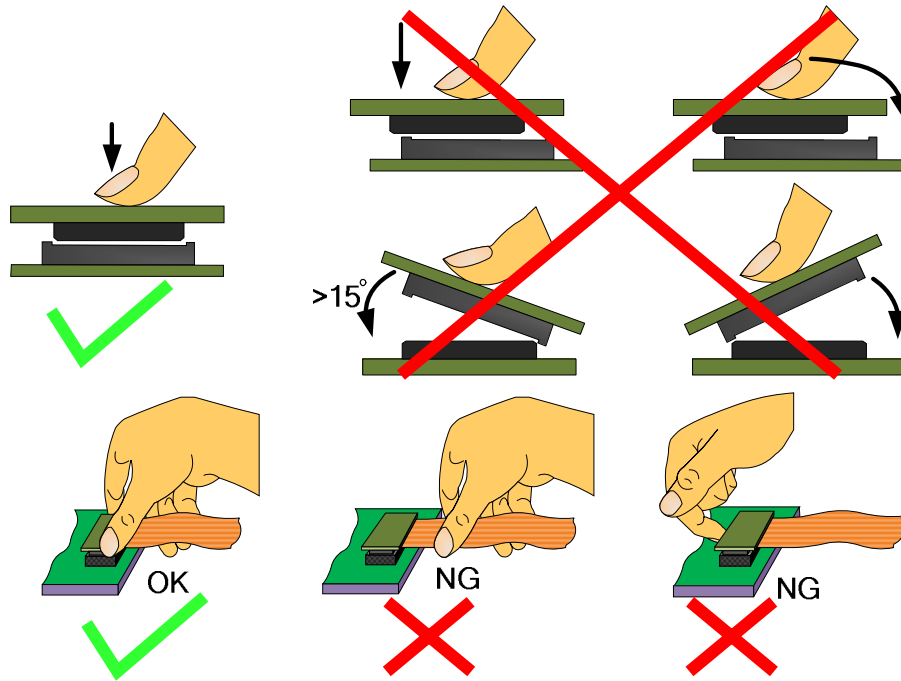

4.3 Precaution for soldering the LCM

	Manual soldering	Machine drag soldering	Machine press soldering
No RoHS Product	290°C ~350°C. Time : 3-5S.	330°C ~350°C. Speed : 15-17 mm/s.	300°C ~330°C. Time : 3-6S. Press: 0.8~1.2Mpa
RoHS Product	340°C ~370°C. Time : 3-5S.	350°C ~370°C. Speed : 15-17 mm/s.	330°C ~360°C. Time : 3-6S. Press: 0.8~1.2Mpa

- 4.3.1 If soldering flux is used, be sure to remove any remaining flux after finishing to soldering operation (This does not apply in the case of a non-halogen type of flux). It is recommended that you protect the LCD surface with a cover during soldering to prevent any damage due to flux spatters.
- 4.3.2 When soldering the electroluminescent panel and PC board, the panel and board should not be detached more than three times. This maximum number is determined by the temperature and time conditions mentioned above, though there may be some variance depending on the temperature of the soldering iron.
- 4.3.3 When remove the electroluminescent panel from the PC board, be sure the solder has completely melted, the soldered pad on the PC board could be damaged.

4.4 Precautions for Operation

- 4.4.1 Viewing angle varies with the change of liquid crystal driving voltage (VLCD). Adjust VLCD to show the best contrast.
- 4.4.2 It is an indispensable condition to drive LCD's within the specified voltage limit since the higher voltage then the limit cause the shorter LCD life. An electrochemical reaction due to direct current causes LCD's undesirable deterioration, so that the use of direct current drive should be avoided.
- 4.4.3 Response time will be extremely delayed at lower temperature than the operating temperature range and on the other hand at higher temperature LCD's show dark color in them. However those phenomena do not mean malfunction or out of order with LCD's, which will come back in the specified operating temperature.
- 4.4.4 If the display area is pushed hard during operation, the display will become abnormal. However, it will return to normal if it is turned off and then back on.
- 4.4.5 A slight dew depositing on terminals is a cause for electro-chemical reaction resulting in terminal open circuit. Usage under the maximum operating temperature, 50%RH or less is required.
- 4.4.6 Input logic voltage before apply analog high voltage such as LCD driving voltage when power on. Remove analog high voltage before logic voltage when power off the module. Input each signal after the positive/negative voltage becomes stable.
- 4.4.7 Please keep the temperature within the specified range for use and storage. Polarization degradation, bubble generation or polarizer peel-off may occur with high temperature and high humidity.

4.5 Safety

- 4.5.1 It is recommended to crush damaged or unnecessary LCDs into pieces and wash them off with solvents such as acetone and ethanol, which should later be burned.
- 4.5.2 If any liquid leaks out of a damaged glass cell and comes in contact with the hands, wash off thoroughly with soap and water.

4.6 Limited Warranty

Unless agreed between Multi-Inno and the customer, Multi-Inno will replace or repair any of its LCD modules which are found to be functionally defective when inspected in accordance with Multi-Inno LCD acceptance standards (copies available upon request) for a period of one year from date of production. Cosmetic/visual defects must be returned to Multi-Inno within 90 days of shipment. Confirmation of such date shall be based on data code on product. The warranty liability of Multi-Inno limited to repair and/or replace on the terms set forth above. Multi-Inno will not be responsible for any subsequent or consequential events.

4.7 Return LCM under warranty

4.7.1 No warranty can be granted if the precautions stated above have been disregarded. The typical examples of violations are :

4.7.1.1 - Broken LCD glass.

4.7.1.2 - PCB eyelet is damaged or modified.

4.7.1.3 -PCB conductors damaged.

4.7.1.4 - Circuit modified in any way, including addition of components.

4.7.1.5 - PCB tampered with by grinding, engraving or painting varnish.

4.7.1.6 - Soldering to or modifying the bezel in any manner.

4.7.2 Module repairs will be invoiced to the customer upon mutual agreement. Modules must be returned with sufficient description of the failures or defects. Any connectors or cable installed by the customer must be removed completely without damaging the PCB eyelet, conductors and terminals.

■ PACKING SPECIFICATION

Please consult our technical department for detail information.

■ PRIOR CONSULT MATTER

- 1 For Multi-Inno standard products, we keep the right to change material, process ... for improving the product property without prior notice to our customer.
- 2 For OEM products, if any changes are needed which may affect the product property, we will consult with our customer in advance.
- 3 If you have special requirement about reliability condition, please let us know before you start the test on our samples.