



**MULTI-INNO TECHNOLOGY CO., LTD.**

[www.multi-inno.com](http://www.multi-inno.com)

## LCD MODULE SPECIFICATION

**Model : MI1010AAT-2**

This module uses RoHS material

### For Customer's Acceptance:

Customer	
Approved	
Comment	

The standard product specification may change without prior notice in order to improve performance or quality. Please contact Multi-Inno for updated specification and product status before design for the standard product or release of the order.

Revision	1.3
Engineering	
Date	2018-10-31
Our Reference	



# CONTENTS

- GENERAL INFORMATION
- EXTERNAL DIMENSIONS
- ABSOLUTE MAXIMUM RATINGS
- ELECTRICAL CHARACTERISTICS
- BACKLIGHT CHARACTERISTICS
- ELECTRO-OPTICAL CHARACTERISTICS
- INTERFACE DESCRIPTION
- BLOCK DIAGRAM
- APPLICATION NOTES
- RELIABILITY TEST
- INSPECTION CRITERION
- PRECAUTIONS FOR USING LCD MODULES
- PRIOR CONSULT MATTER

**■ GENERAL INFORMATION**

Item	Contents	Unit
LCD type	TFT/Transmissive/Normally black	/
Size	10.1	Inch
Viewing direction	Full viewing angle	O' Clock
LCM (W × H × D )	229.70×149.15×5.00	mm <sup>3</sup>
Active area (W×H)	216.96×135.60	mm <sup>2</sup>
Pixel pitch (W×H)	0.1695×0.1695	mm <sup>2</sup>
Number of dots	1280(RGB) × 800	/
Driver IC	HX8245 + HX8695	/
Backlight type	36 LEDs	/
Interface type	4-lane LVDS (24-bit data)	/
Color depth	16.7M	/
Pixel configuration	R.G.B vertical stripe	/
Top polarizer surface treatment	Glare	/
Input voltage	3.3	V
With/Without TSP	Without TSP	/
TP surface treatment	TBD	/
Weight	TBD	g

Note 1: RoHS compliant;

Note 2: LCM weight tolerance: ± 5% .

**EXTERNAL DIMENSIONS**

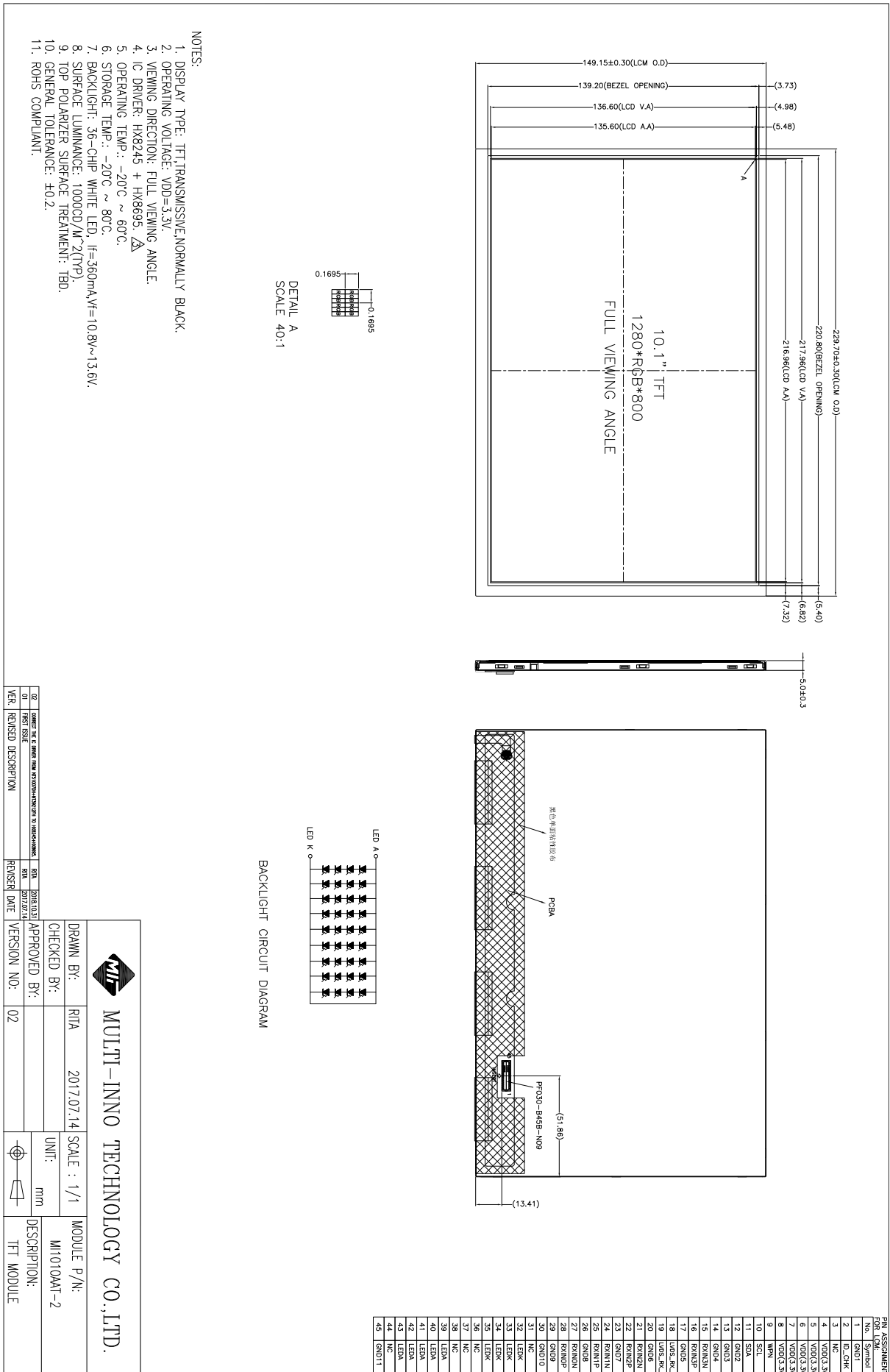

02	UPDATED THE E- DRAWING FROM AUTOCAD DRAWING TO MICROSOFT VISIO	RITA	2017.07.14	VERSION NO.	02
01	FRIST ISSUE	RITA	2017.07.14	VERSION NO.	01
VER.	REVISED DESCRIPTION	REVISER	DATE	VERSION NO.	

	<b>MULTI-INNO TECHNOLOGY CO.,LTD.</b>
DRAWN BY: RITA CHECKED BY: APPROVED BY:	SCALE: 1/1 UNIT: mm DESCRIPTION: TFT MODULE

## ■ ABSOLUTE MAXIMUM RATINGS

Parameter	Symbol	Min	Max	Unit
Power supply voltage	VDD	-0.3	5.0	V
Backlight forward current	I <sub>LED</sub>	-	60	mA
Operating temperature	T <sub>OP</sub>	-20	60	°C
Storage temperature	T <sub>ST</sub>	-20	80	°C

Note :The absolute maximum rating values of this product are not allowed to be exceeded at any times.Should a module be used with any of the absolute maximum ratings exceeded,the characteristics of the module may not be recovered,or in an extreme case,the module may be permanently destroyed.

## ■ ELECTRICAL CHARACTERISTICS

Parameter	Symbol	Min	Typ	Max	Unit
Power supply voltage	VDD	3.0	3.3	3.6	V
Power supply current	IDD	-	-	260	mA
Input voltage ' H ' level	V <sub>IH</sub>	0.7VDD	-	VDD	V
Input voltage ' L ' level	V <sub>IL</sub>	GND	-	0.3VDD	V

## ■ BACKLIGHT CHARACTERISTICS

Item	Symbol	Min.	Typ.	Max.	Unit	Condition
Forward voltage	V <sub>f</sub>	10.8	12.8	13.6	V	T <sub>a</sub> =25±2°C, 60%RH±5%
Forward current	I <sub>f</sub>	-	360	-	mA	
Power consumption	W <sub>BL</sub>	-	4608	-	mW	
Operating life time	-	30000	50000	-	Hrs	

Note :

Operating life time means brightness goes down to 50% initial brightness;

The life time of LED will be reduced if LED is driven by high current,high ambient temperature and humidity conditions;

Typical operating life time is an estimated data.

## ■ELECTRO-OPTICAL CHARACTERISTICS

Item	Symbol	Condition	Min	Typ	Max	Unit	Remark	Note
Response time	Tr+Tf	$\theta=0^\circ$ $\varnothing=0^\circ$ $T_a=25^\circ\text{C}$	-	30	50	ms	FIG 1.	4
Contrast ratio	Cr		700	900	-	---	FIG 2.	1
Luminance uniformity	$\delta$ WHITE		70	75	-	%	FIG 2.	3
Surface Luminance	Lv		800	1000	-	cd/m <sup>2</sup>	FIG 2.	2
Viewing angle range	$\theta$	$\varnothing = 90^\circ$	80	-	-	deg	FIG 3.	6
		$\varnothing = 270^\circ$	80	-	-	deg	FIG 3.	
		$\varnothing = 0^\circ$	80	-	-	deg	FIG 3.	
		$\varnothing = 180^\circ$	80	-	-	deg	FIG 3.	
CIE (x, y) chromaticity	Red	x	-	TBD	-	FIG 2.	5	
		y	-	TBD	-			
	Green	x	-	TBD	-			
		y	-	TBD	-			
	Blue	x	-	TBD	-			
		y	-	TBD	-			
	White	x	0.253	0.303	0.353			
		y	0.259	0.339	0.389			

Note 1. Contrast Ratio(CR) is defined mathematically as For more information see FIG 2.

$$\text{Contrast Ratio} = \frac{\text{Average Surface Luminance with all white pixels (P1, P2, P3, P4, P5)}}{\text{Average Surface Luminance with all black pixels (P1, P2, P3, P4, P5)}}$$

Note 2. Surface luminance is the LCD surface from the surface with all pixels displaying white. For more information see FIG 2.

$$L_v = \text{Average Surface Luminance with all white pixels (P1, P2, P3, P4, P5)}$$

Note 3. The uniformity in surface luminance ,  $\delta$  WHITE is determined by measuring luminance at each test position 1 through 5, and then dividing the maximum luminance of 5 points luminance by minimum luminance of 5 points luminance. For more information see FIG 2.

$$\delta \text{ WHITE} = \frac{\text{Minimum Surface Luminance with all white pixels (P1, P2, P3, P4, P5)}}{\text{Maximum Surface Luminance with all white pixels (P1, P2, P3, P4, P5)}}$$

Note 4. Response time is the time required for the display to transition from White to black(Rise Time, Tr) and from black to white(Decay Time, Tf). For additional information see FIG 1. The test equipment is Autronic-Melchers's ConoScope. Series.

Note 5. CIE (x, y) chromaticity, The x, y value is determined by measuring luminance at each test position 1 through 5, and then make average value.

Note 6. Viewing angle is the angle at which the contrast ratio is greater than 2. For TFT module the contrast ratio is greater than 10. The angles are determined for the horizontal or x axis and the vertical or y axis with respect to the z axis which is normal to the LCD surface. For more information see FIG 3.

Note 7. For viewing angle and response time testing, the testing data is base on Autronic-Melchers's ConoScope. Series Instruments For contrast ratio, Surface Luminance, Luminance uniformity, CIE The test data is base on TOPCON's BM-5 photo detector.

**FIG. 1 The definition of Response Time**

The response time is defined as the following figure and shall be measured by switching the input signal for “black” and “white”.

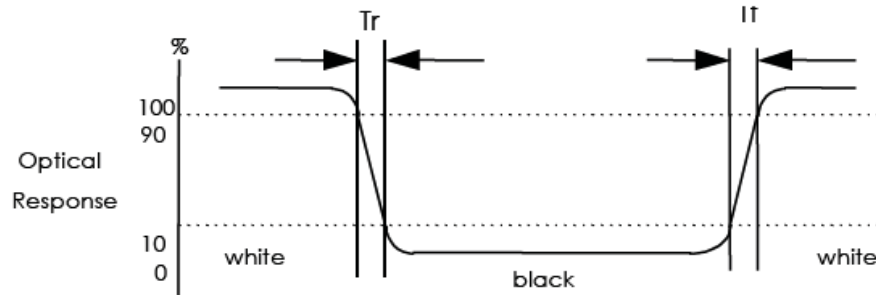
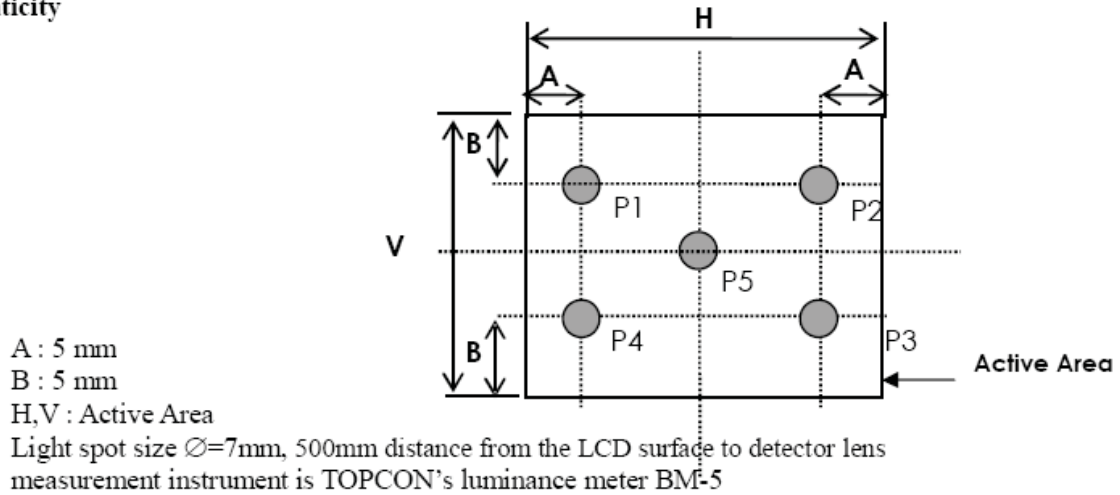
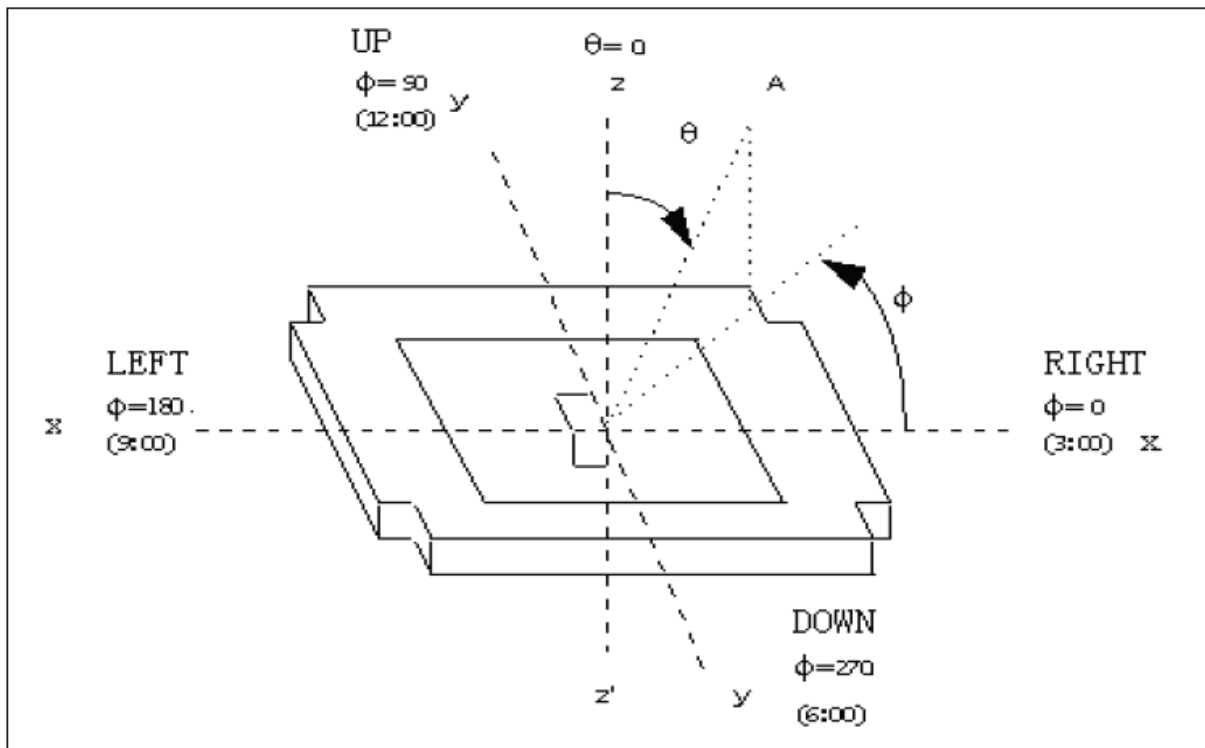
**FIG. 2 Measuring method for Contrast ratio, surface luminance, Luminance uniformity , CIE (x, y) chromaticity**

**FIG. 3 The definition of viewing angle**

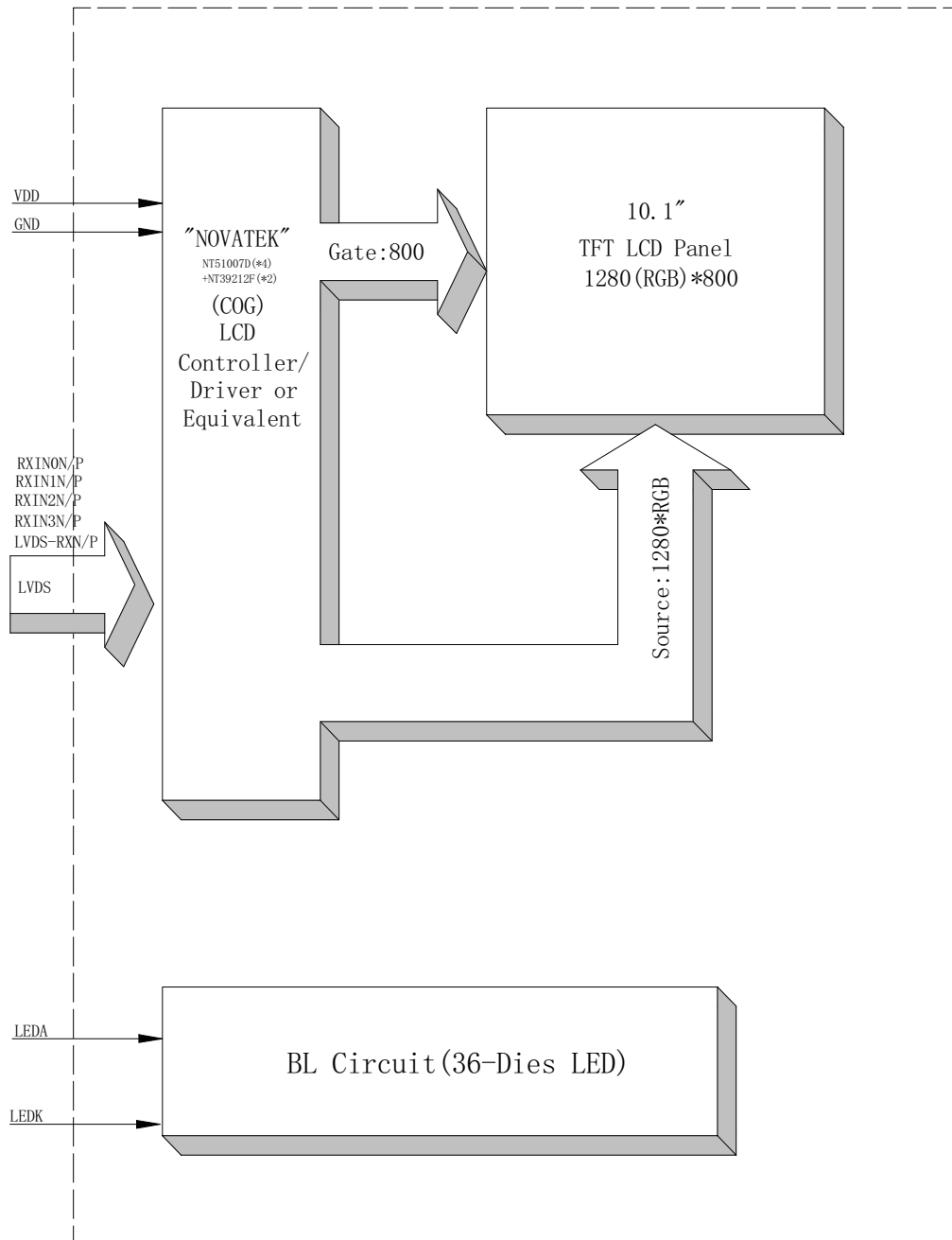

**■ INTERFACE DESCRIPTION**

Pin No.	Symbol	Description
1	GND	Ground
2	ID-CHK	Product ID signal output (1.8V)
3	NC	No connection
4	VDD	Power supply votage.(3.3V)
5	VDD	Power supply votage.(3.3V)
6	VDD	Power supply votage.(3.3V)
7	VDD	Power supply votage.(3.3V)
8	VDD	Power supply votage.(3.3V)
9	WPN	No connection
10	SCL	No connection
11	SDA	No connection
12	GND	Ground
13	GND	Ground
14	GND	Ground
15	RXIN3N	-LVDS differential data input
16	RXIN3P	+ LVDS differential data input
17	GND	Ground
18	LVDS-RX-N	-LVDS differential clock input
19	LVDS-RX-P	+ LVDS differential clock input
20	GND	Ground
21	RXIN2N	-LVDS differential data input
22	RXIN2P	+ LVDS differential data input
23	GND	Ground
24	RXININ	-LVDS differential data input
25	RXINIP	+ LVDS differential data input
26	GND	Ground
27	RXJN0N	-LVDS differential data input
28	RXIN0P	+ LVDS differential data input
29	GDN	Ground
30	GND	Ground
31	NC	No connection
32	LEDK	LED cathode
33	LEDK	LED cathode
34	LEDK	LED cathode
35	LEDK	LED cathode
36	NC	No connection
37	NC	No connection
38	NC	No connection
39	LEDA	LED anode
40	LEDA	LED anode
41	LEDA	LED anode
42	LEDA	LED anode
43	LEDA	LED anode
44	NC	No connection
45	GND	Ground

**■ BLOCK DIAGRAM**

## ■ APPLICATION NOTES

### 1. LVDS Timing Specification

Signal	Item	Symbol	Min	Type	Max	Unit
DCLK	Frequency	1/TC	60	65	70	MHz
	Cycle	Tc	16.66	15.38	14.3	ns
DE	Horizontal Period	THd	1280	1280	1280	Tc
	Horizontal Cycle	TH	1310	1330	1560	Tc
		TH_time	19.5	20.46	21.83	ns
	Vertical Period	TVd	800	800	800	Tc
	Vertical Cycle	TV	-	812	-	Tc

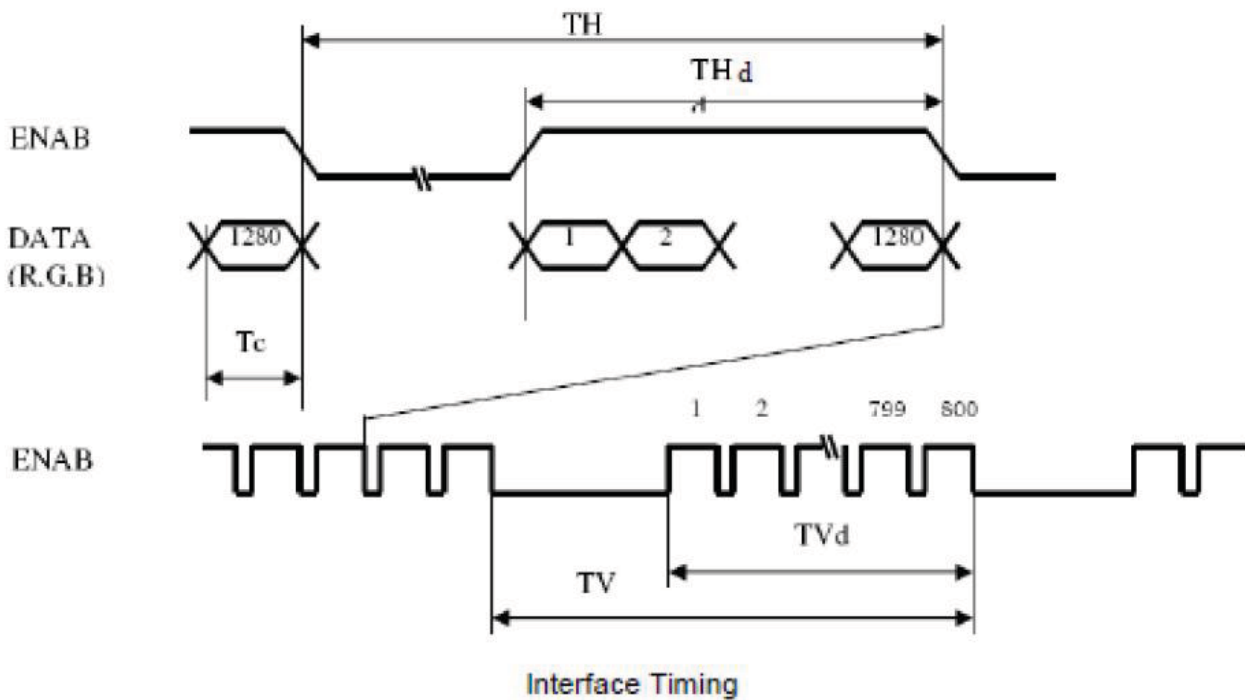

## 2. LVDS Rx Interface Timing Parameter

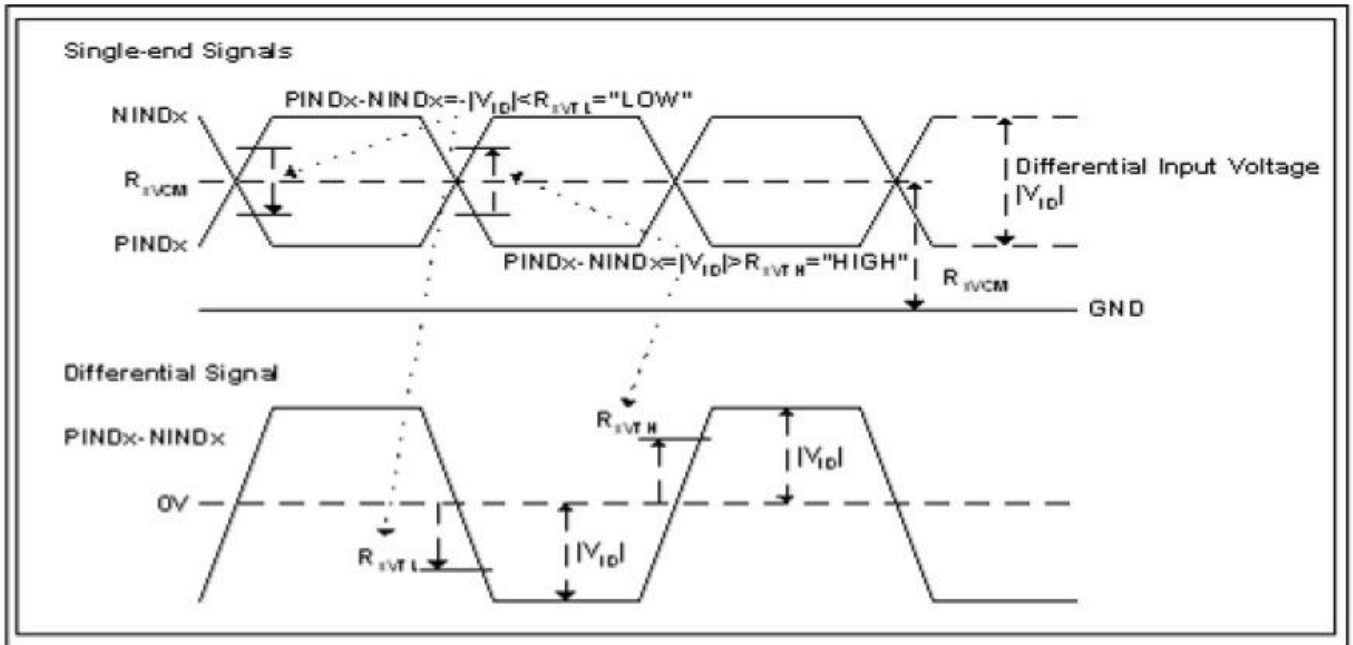

## 3. Input Clock And Timing Diagram

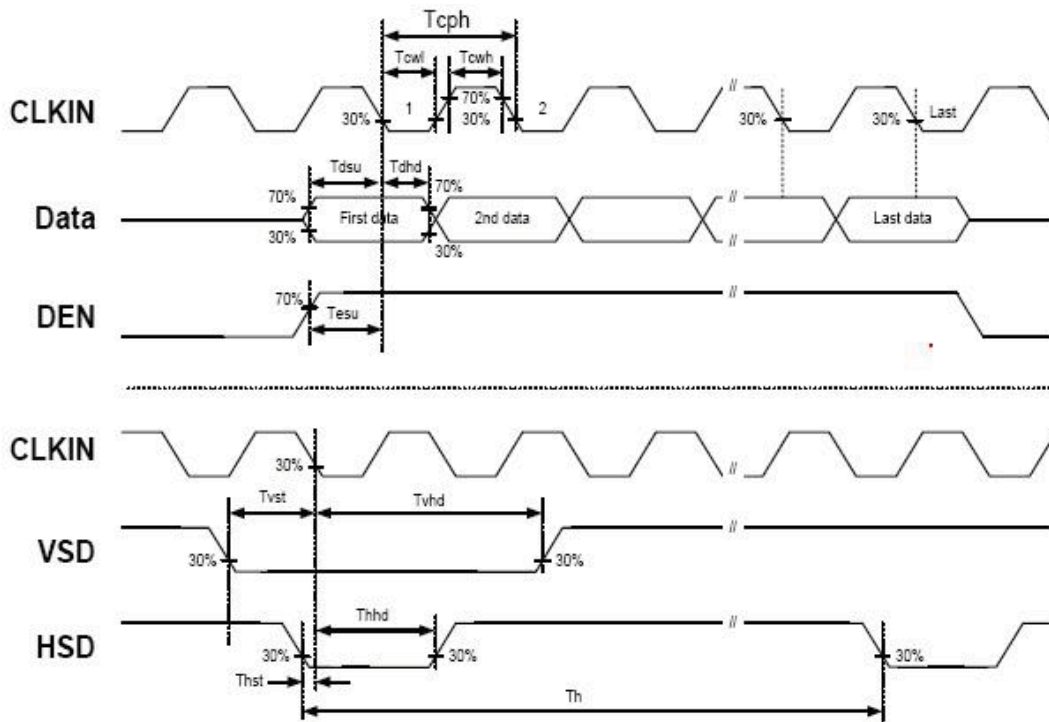

#### 4. LVDS Interface

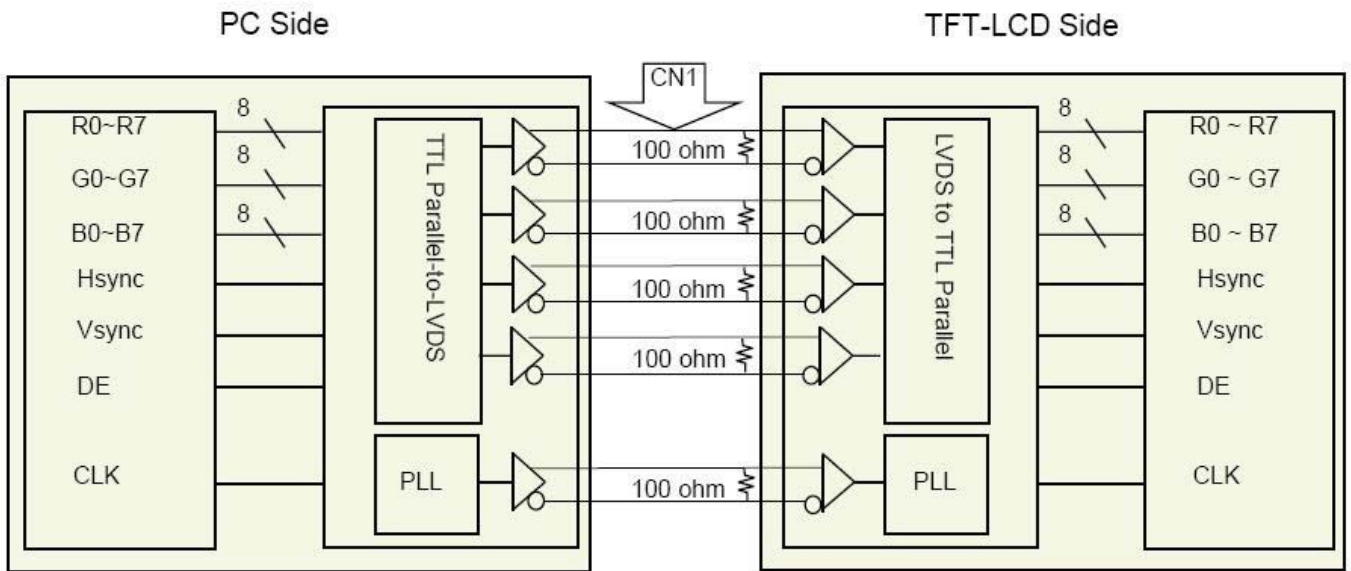

#### 5. LVDS Input Signal

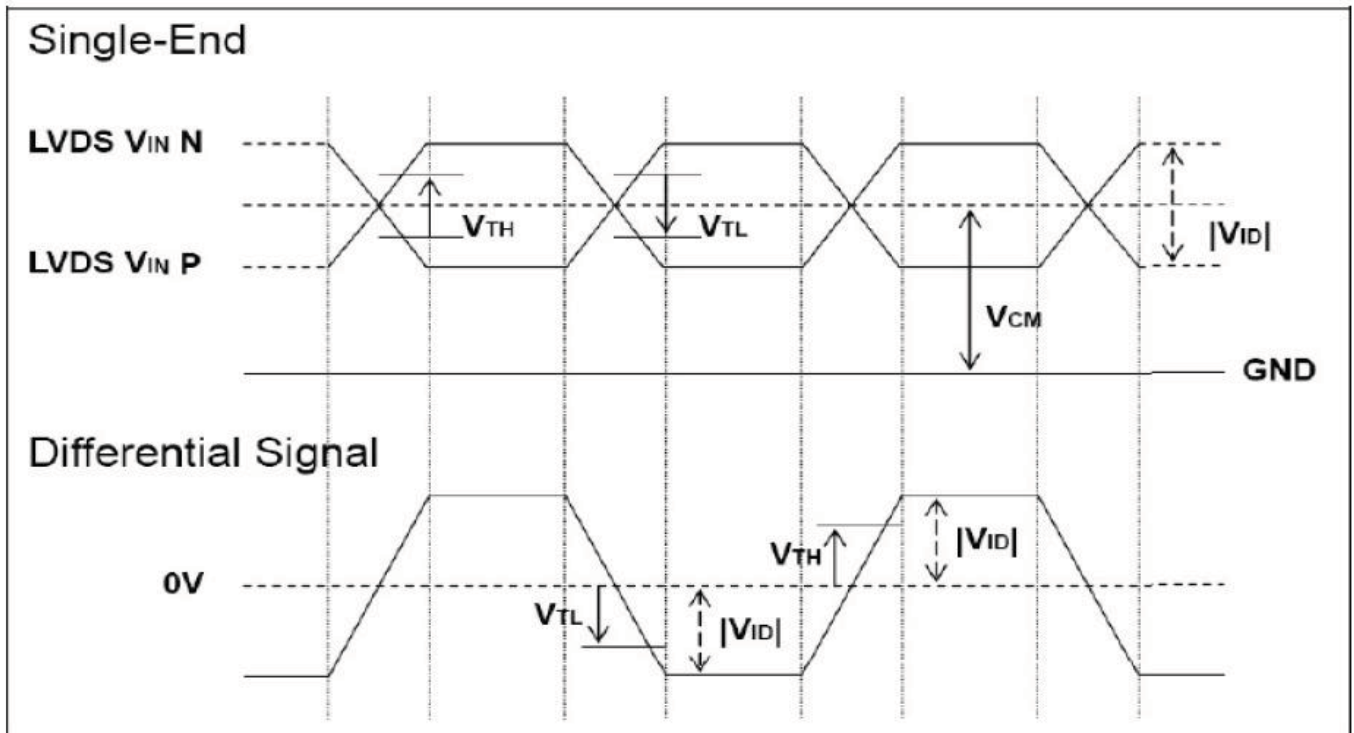

### 6. Data Input Format

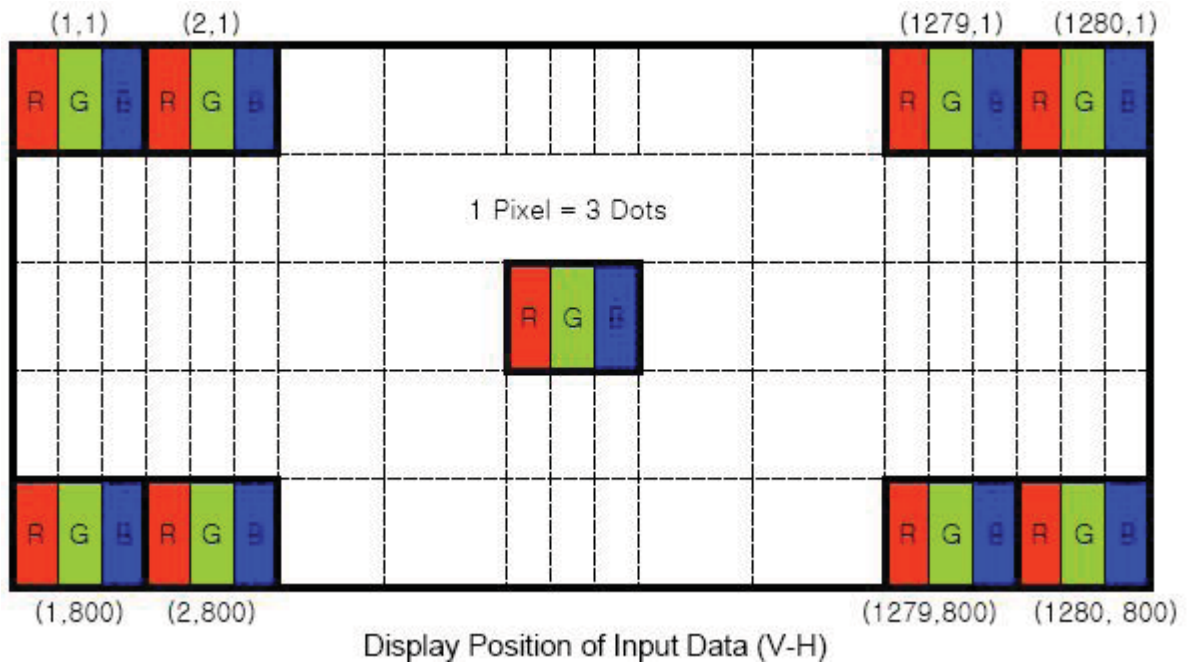

**■ RELIABILITY TEST**

No.	Test Item	Test Condition	Remarks
1	High Temperature Storage Test	80°C±2°C/240Hrs.	Note2
2	Low Temperature Storage Test	-20°C±2°C/240Hrs.	Note1,2
3	High Temperature Operation Test	60°C±2°C/240Hrs.	
4	Low Temperature Operation Test	-20°C±2°C/240Hrs.	Note1
5	High Temperature and High Humidity Operation Test	60±5°C, 90%RH 240Hrs.	Note1,2
6	Thermal Shock Test (Non-operating)	-20±2°C(30Min.)~25±2°C(5Min.)~60±2°C(30Min.) 100Cycles	
7	Vibration Test (Non-operating)	Frequency:10~55Hz Amplitude: 1.5mm Sweep Time: 11Mins Test Period: 6 Cycles For Each Direction Of X, Y, Z (Packing Condition)	
8	Shock Test (Non-operating)	200G, 2Ms Direction: ±X, ±Y, ±Z Cycle: 3 Times	
9	Electro Static Discharge Test (Operating)	R:330Ω, C:150pF, 5points/panel Air: ±15KV, 5times; Contact:±8KV, 5times; (Environment:15°C ~35°C, 30%~60%, 86Kpa~106Kpa)	

Note 1: Without water condensation

Note 2: The function test shall be conducted after 2 hours storage at the room temperature and humidity after removed from the test chamber.

**INSPECTION CRITERION**

 <p style="text-align: center;">OUTGOING QUALITY STANDARD</p>	PAGE 1 OF 5
TITLE:FUNCTIONAL TEST & INSPECTION CRITERIA	

This specification is made to be used as the standard acceptance/rejection criteria for TFT module.

1 Sample plan

- 1.1 Lot size: Quantity per shipment lot per model
- 1.2 Sampling type: Normal inspection, Single sampling
- 1.3 Inspection level: II
- 1.4 Sampling table: MIL-STD-105D
- 1.5 Acceptable quality level (AQL)

Major defect: AQL=0.65

Minor defect: AQL=1.50

2. Inspection condition

2.1 Ambient conditions:

- a. Temperature: Room temperature  $25 \pm 5^\circ\text{C}$
- b. Humidity:  $(60 \pm 10)\% \text{RH}$
- c. Illumination: Single fluorescent lamp non-directive (300 to 700 Lux)

2.2 Viewing distance:

The distance between the LCD and the inspector's eyes shall be at least  $35 \pm 5\text{cm}$ .

2.3 Viewing Angle

U/D:  $45^\circ / 45^\circ$  , L/R:  $45^\circ / 45^\circ$

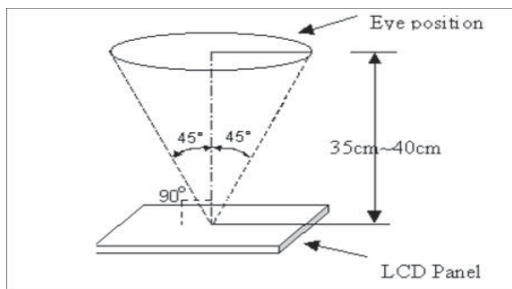

3. Definition of Inspection Item.

3.1 Definition of inspection zone in LCD.

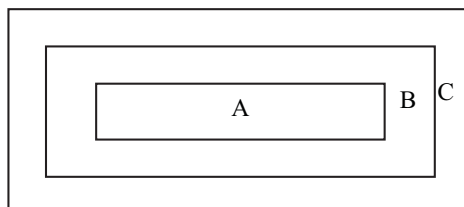

Zone A: character/Digit area

Zone B: viewing area except Zone A (ZoneA+ZoneB=minimum Viewing area)

Zone C: Outside viewing area (invisible area after assembly in customer's product)

Fig.1 Inspection zones in an LCD.

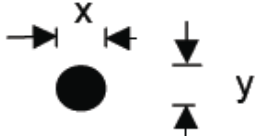

 OUTGOING QUALITY STANDARD		PAGE 2 OF 5	
TITLE:FUNCTIONAL TEST & INSPECTION CRITERIA			
Note: As a general rule, visual defects in Zone C are permissible, when it is no trouble for quality and assembly of customer's product.			
4. Inspection standards Defects are classified as major defects and minor defects according to the degree of defectiveness defined herein.			
4.1 Major defect			
Item No	Items to be inspected	Inspection Standard	
4.1.1	All functional defects	1) No display 2) Display abnormally 3) Short circuit 4) Line defect 5) Excess power consumption	
4.1.2	Missing	Missing function component	
4.1.3	Crack	Glass crack	
4.2 Minor defect			
Item No	Items to be inspected	Inspection standard	
4.2.1	Spot Defect Including Black spot White spot Pinhole Foreign particle Polarizer dirt	For dark/white spot is defined $\varphi = (x+y) / 2$ 	
		Size $\varphi$ (mm)	Acceptable Quantity
		$\varphi \leq 0.25$ 2mm(min) apart	Ignore
		$0.25 < \varphi \leq 0.50$ 5mm(min) apart	5
		$0.50 < \varphi$	Not allowed

OUTGOING QUALITY STANDARD		PAGE 3 OF 5	
TITLE:FUNCTIONAL TEST & INSPECTION CRITERIA			
4.2.2	Line Defect Including Black line White line Scratch	Define: 	
		Width(mm) Length(mm)	Acceptable Quantity
		$W \leq 0.06$ and $L \leq 10$	Ignore
		$0.06 < W \leq 0.08$ and $L \leq 10$ 5mm(min) apart	5
		$0.08 < W \leq 0.10$ and $L \leq 5$ 5mm(min) apart	3
$0.10 < W$ or $10 < L$	Not allowed		
4.2.3	Polarizer Dent/Bubble	Size $\varphi$ (mm)	Acceptable Quantity
		$\varphi \leq 0.30$	Ignore
		Non visible area	Ignore
		$0.30 < \varphi \leq 0.50$ 5mm(min) apart	5
		$0.50 < \varphi$	Not allowed
4.2.4	Electrical Dot Defect	Bright and Black dot define: 	
		Inspection pattern: Full white, Full black, Red, green and blue screens	
		Item	Acceptable Quantity
		Black dot defect	5
		Bright dot defect	2
Total Dot	5		

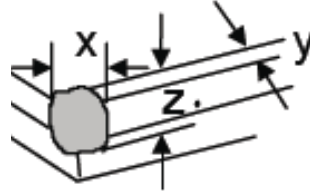
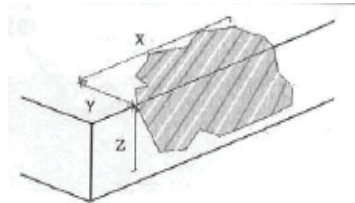
	<p>OUTGOING QUALITY STANDARD</p>	<p>PAGE 4 OF 5</p>	
<p>TITLE:FUNCTIONAL TEST &amp; INSPECTION CRITERIA</p>			
<p>4.2.5</p>	<p>Touch panel chips</p>	<p>1. Corner chips:</p>	
		<p>Size(mm)</p>	<p>Acceptable Quantity</p>
		<p><math>X \leq 3\text{mm}</math>  <math>Y \leq 3\text{mm}</math>  <math>Z \leq T</math></p>	<p>Ignore  T: Glass thickness  X: Length  Y: Width  Z: thickness</p>
		<p>2. Side chips:</p>	
		<p>Size(mm)</p>	<p>Acceptable Quantity</p>
		<p><math>X \leq 5\text{mm}</math>  <math>Y \leq 3\text{mm}</math>  <math>Z \leq T</math></p>	<p>Ignore  T: Glass thickness  X: Length  Y: Width  Z: thickness</p>



 OUTGOING QUALITY STANDARD	PAGE 5 OF 5
TITLE:FUNCTIONAL TEST & INSPECTION CRITERIA	
<p>Note:</p> <ol style="list-style-type: none"><li>1. Dot defect is defined as the defective area of the dot area is larger than 50% of the dot area.</li><li>2. The distance between black dot defects or black and bright dot defects should be more than 5mm apart. The distance between two bright dot defects should be more than 15mm apart</li><li>3. Polarizer bubble is defined as the bubble appears on active display area. The defect of polarizer bubble shall be ignored if the polarizer bubble appears on the outside of active display area.</li><li>4. Mura is checker by 6% ND filter.</li><li>5. Foreign particle on the surface of the LCM should be ignore.</li></ol>	

## ■ PRECAUTIONS FOR USING LCD MODULES

### Handing Precautions

(1) The display panel is made of glass and polarizer. As glass is fragile. It tends to become or chipped during handling especially on the edges. Please avoid dropping or jarring. Do not subject it to a mechanical shock by dropping it or impact.

(2) If the display panel is damaged and the liquid crystal substance leaks out, be sure not to get any in your mouth. If the substance contacts your skin or clothes, wash it off using soap and water.

(3) Do not apply excessive force to the display surface or the adjoining areas since this may cause the color tone to vary. Do not touch the display with bare hands. This will stain the display area and degraded insulation between terminals (some cosmetics are determined to the polarizer).

(4) The polarizer covering the display surface of the LCD module is soft and easily scratched. Handle this polarizer carefully. Do not touch, push or rub the exposed polarizers with anything harder than an HB pencil lead (glass, tweezers, etc.). Do not put or attach anything on the display area to avoid leaving marks on. Condensation on the surface and contact with terminals due to cold will damage, stain or dirty the polarizer. After products are tested at low temperature they must be warmed up in a container before coming is contacting with room temperature air.

(5) If the display surface becomes contaminated, breathe on the surface and gently wipe it with a soft dry cloth. If it is heavily contaminated, moisten cloth with one of the following solvents

- Isopropyl alcohol
- Ethyl alcohol

Do not scrub hard to avoid damaging the display surface.

(6) Solvents other than those above-mentioned may damage the polarizer. Especially, do not use the following.

- Water
- Ketone
- Aromatic solvents

Wipe off saliva or water drops immediately, contact with water over a long period of time may cause deformation or color fading. Avoid contacting oil and fats.

(7) Exercise care to minimize corrosion of the electrode. Corrosion of the electrodes is accelerated by water droplets, moisture condensation or a current flow in a high-humidity environment.

(8) Install the LCD Module by using the mounting holes. When mounting the LCD module make sure it is free of twisting, warping and distortion. In particular, do not forcibly pull or bend the I/O cable or the backlight cable.

(9) Do not attempt to disassemble or process the LCD module.

(10) NC terminal should be open. Do not connect anything.

(11) If the logic circuit power is off, do not apply the input signals.

(12) Electro-Static Discharge Control, Since this module uses a CMOS LSI, the same careful attention should be paid to electrostatic discharge as for an ordinary CMOS IC. To prevent destruction of the elements by static electricity, be careful to maintain an optimum work environment.

- Before remove LCM from its packing case or incorporating it into a set, be sure the module and your body have the same electric potential. Be sure to ground the body when handling the LCD modules.

- Tools required for assembling, such as soldering irons, must be properly grounded. make certain the AC power source for the soldering iron does not leak. When using an electric screwdriver to attach LCM, the screwdriver should be of ground potentiality to minimize as much as possible any transmission of electromagnetic waves produced sparks coming from the commutator of the motor.

- To reduce the amount of static electricity generated, do not conduct assembling and other work under dry conditions. To reduce the generation of static electricity be careful that the air in the work is not too dried. A relative humidity of 50%-60% is recommended. As far as possible make the electric potential of your work clothes and that of the work bench the ground potential

- The LCD module is coated with a film to protect the display surface. Exercise care when peeling off this protective film since static electricity may be generated

(13) Since LCM has been assembled and adjusted with a high degree of precision, avoid applying excessive shocks to the module or making any alterations or modifications to it.

- Do not alter, modify or change the shape of the tab on the metal frame.
- Do not make extra holes on the printed circuit board, modify its shape or change the positions of components to be attached.
- Do not damage or modify the pattern writing on the printed circuit board.
- Absolutely do not modify the zebra rubber strip (conductive rubber) or heat seal connector.
- Except for soldering the interface, do not make any alterations or modifications with a soldering iron.
- Do not drop, bend or twist LCM.

**Handling precaution for LCM**

LCM is easy to be damaged.  
Please note below and be careful for handling!

**Correct handling:**



As above picture, please handle with anti-static gloves around LCM edges.

**Incorrect handling:**

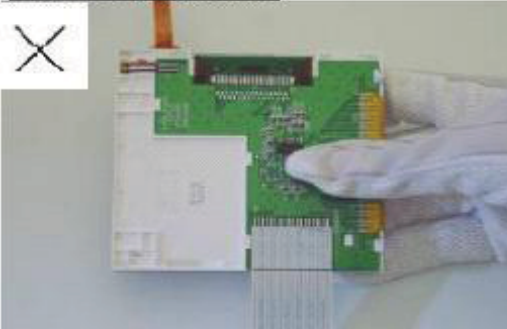

Please don't touch IC directly.

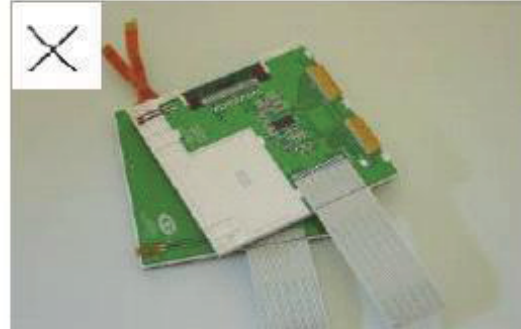

Please don't stack LCM.

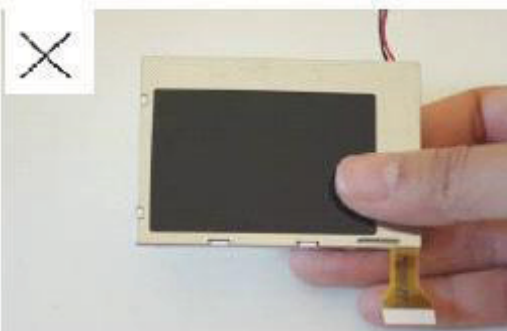

Please don't hold the surface of panel.

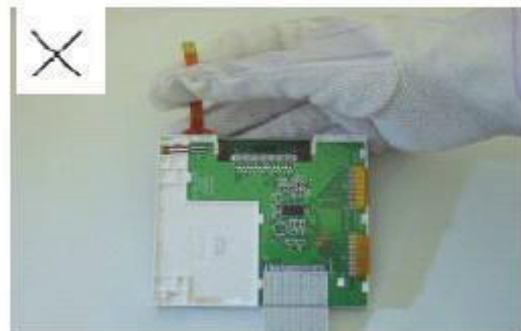

Please don't stretch interface of output, such as FPC cable.

**Handling precaution for LCD**

LCD is easy to be damaged.  
Please note below and be careful for handling!

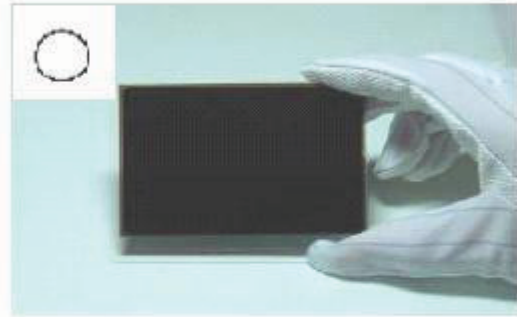
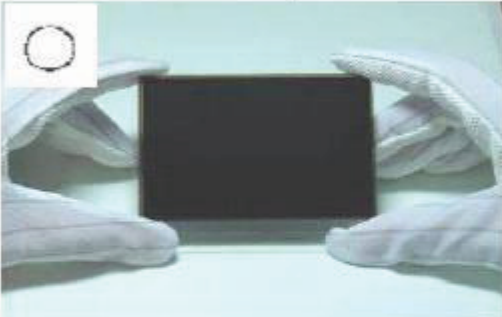
**Correct handling:**

As above photo, please handle with anti-static gloves around LCD edges.

**Incorrect handling:**

Please don't stack the LCDS.

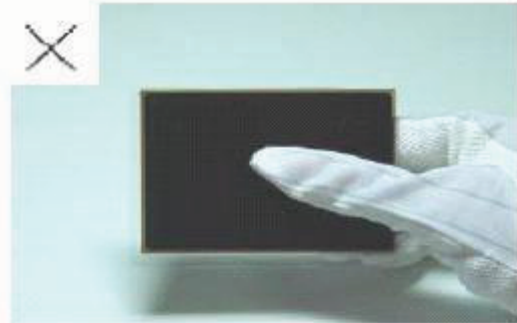

Please don't hold the surface of LCD.

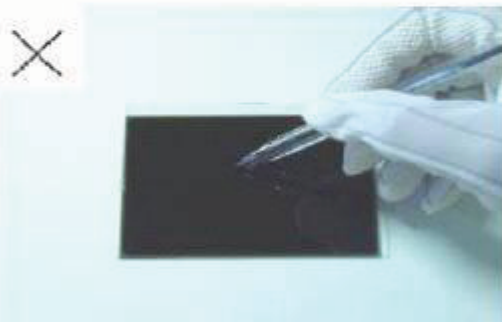

Please don't operate with sharp stick such as pens.

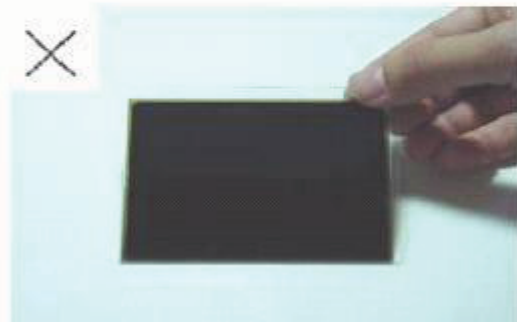

Please don't touch ITO glass without anti-static gloves.

### Storage Precautions

When storing the LCD modules, the following precaution is necessary.

- (1) Store them in a sealed polyethylene bag. If properly sealed, there is no need for the dessicant.
- (2) Store them in a dark place. Do not expose to sunlight or fluorescent light, keep the temperature between 0°C and 35°C, and keep the relative humidity between 40%RH and 60%RH.
- (3) The polarizer surface should not come in contact with any other objects. (We advise you to store them in the anti-static electricity container in which they were shipped.

#### Others

Liquid crystals solidify under low temperature (below the storage temperature range) leading to defective orientation or the generation of air bubbles (black or white). Air bubbles may also be generated if the module is subject to a low temperature.

If the LCD modules have been operating for a long time showing the same display patterns, the display patterns may remain on the screen as ghost images and a slight contrast irregularity may also appear. A normal operating status can be regained by suspending use for some time. It should be noted that this phenomenon does not adversely affect performance reliability.

To minimize the performance degradation of the LCD modules resulting from destruction caused by static electricity etc., exercise care to avoid holding the following sections when handling the modules.

- Exposed area of the printed circuit board.
- Terminal electrode sections.

### USING LCD MODULES

#### Installing LCD Modules

The hole in the printed circuit board is used to fix LCM as shown in the picture below. Attend to the following items when installing the LCM.

- (1) Cover the surface with a transparent protective plate to protect the polarizer and LC cell.

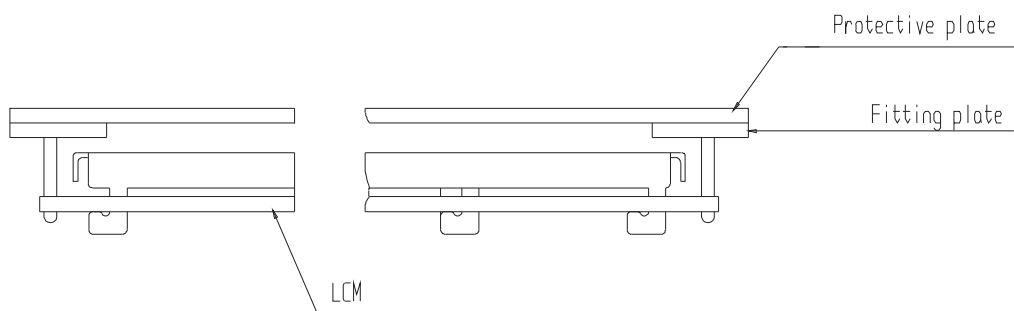

- (2) When assembling the LCM into other equipment, the spacer to the bit between the LCM and the fitting plate should have enough height to avoid causing stress to the module surface, refer to the individual specifications for measurements. The measurement tolerance should be  $\pm 0.1$ mm.

#### Precaution for assemble the module with BTB connector:

Please note the position of the male and female connector position, don't assemble or assemble like the method which the following picture shows

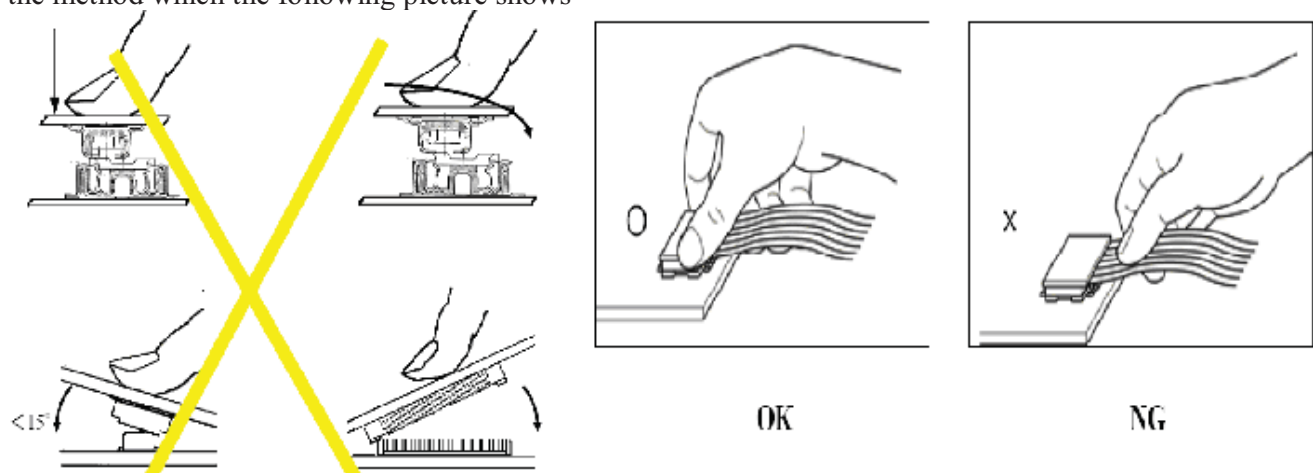



### Precaution for soldering to the LCM

	Hand soldering	Machine drag soldering	Machine press soldering
No ROHS product	290°C ~350°C. Time : 3-5S.	330°C ~350°C. Speed : 4-8 mm/s.	300°C ~330°C. Time : 3-6S. Press: 0.8~1.2Mpa
ROHS product	340°C ~370°C. Time : 3-5S.	350°C ~370°C. Time : 4-8 mm/s.	330°C ~360°C. Time : 3-6S. Press: 0.8~1.2Mpa

(1) If soldering flux is used, be sure to remove any remaining flux after finishing to soldering operation. (This does not apply in the case of a non-halogen type of flux.) It is recommended that you protect the LCD surface with a cover during soldering to prevent any damage due to flux spatters.

(2) When soldering the electroluminescent panel and PC board, the panel and board should not be detached more than three times. This maximum number is determined by the temperature and time conditions mentioned above, though there may be some variance depending on the temperature of the soldering iron.

(3) When remove the electroluminescent panel from the PC board, be sure the solder has completely melted, the soldered pad on the PC board could be damaged.

### Precautions for Operation

(1) Viewing angle varies with the change of liquid crystal driving voltage (VLCD). Adjust VLCD to show the best contrast.

(2) It is an indispensable condition to drive LCD's within the specified voltage limit since the higher voltage then the limit cause the shorter LCD life. An electrochemical reaction due to direct current causes LCD's undesirable deterioration, so that the use of direct current drive should be avoided.

(3) Response time will be extremely delayed at lower temperature than the operating temperature range and on the other hand at higher temperature LCD's show dark color in them. However those phenomena do not mean malfunction or out of order with LCD's, Which will come back in the specified operating temperature.

(4) If the display area is pushed hard during operation, the display will become abnormal. However, it will return to normal if it is turned off and then back on.

(5) A slight dew depositing on terminals is a cause for electro-chemical reaction resulting in terminal open circuit. Usage under the maximum operating temperature, 50%RH or less is required.

(6) Input each signal after the positive/negative voltage becomes stable.

(7) Please keep the temperature within specified range for use and storage. Polarization degradation, bubble generation or polarizer peel-off may occur with high temperature and high humidity.

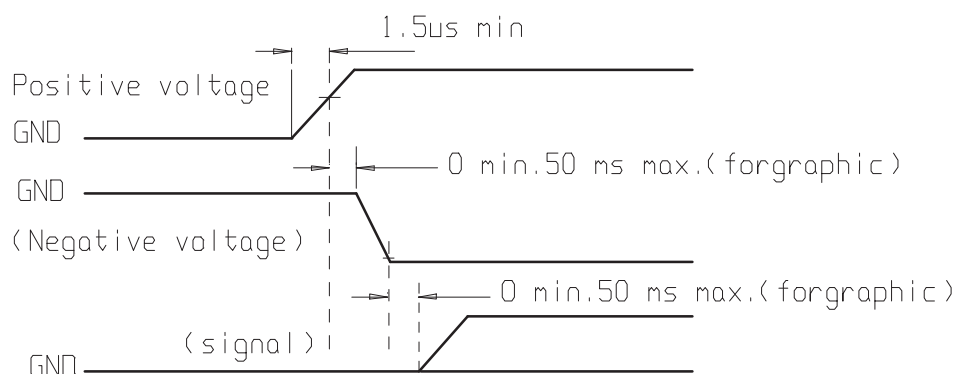

**Safety**

- (1) It is recommended to crush damaged or unnecessary LCDs into pieces and wash them off with solvents such as acetone and ethanol, which should later be burned.
- (2) If any liquid leaks out of a damaged glass cell and comes in contact with the hands, wash off thoroughly with soap and water.

**Limited Warranty**

Unless agreed between Multi-Inno and customer, Multi-Inno will replace or repair any of its LCD modules which are found to be functionally defective when inspected in accordance with Multi-Inno LCD acceptance standards (copies available upon request) for a period of one year from date of production. Cosmetic/visual defects must be returned to Multi-Inno within 90 days of shipment. Confirmation of such date shall be based on data code on product. The warranty liability of Multi-Inno limited to repair and/or replacement on the terms set forth above. Multi-Inno will not be responsible for any subsequent or consequential events.

**Return LCM under warranty**

No warranty can be granted if the precautions stated above have been disregarded. The typical examples of violations are :

- Broken LCD glass.
- PCB eyelet is damaged or modified.
- PCB conductors damaged.
- Circuit modified in any way, including addition of components.
- PCB tampered with by grinding, engraving or painting varnish.
- Soldering to or modifying the bezel in any manner.

Module repairs will be invoiced to the customer upon mutual agreement. Modules must be returned with sufficient description of the failures or defects. Any connectors or cable installed by the customer must be removed completely without damaging the PCB eyelet, conductors and terminals.

**■ PRIOR CONSULT MATTER**

1. ① For Multi-Inno standard products, we keep the right to change material, process ... for improving the product property without notice on our customer.  
② For OEM products, if any change needed which may affect the product property, we will consult with our customer in advance.
2. If you have special requirement about reliability condition, please let us know before you start the test on our samples.