

# Converter - Brake - Inverter Module

## NPT IGBT

Single Phase Rectifier	Brake Chopper	Three Phase Inverter
$V_{RRM} = 1600 \text{ V}$	$V_{CES} = 600 \text{ V}$	$V_{CES} = 600 \text{ V}$
$I_{DAVM25} = 65 \text{ A}$	$I_{C25} = 29 \text{ A}$	$I_{C25} = 29 \text{ A}$
$I_{FSM} = 550 \text{ A}$	$V_{CE(sat)} = 2.1 \text{ V}$	$V_{CE(sat)} = 2.1 \text{ V}$

**Part name** (Marking on product)

MIAA20WE600TMH

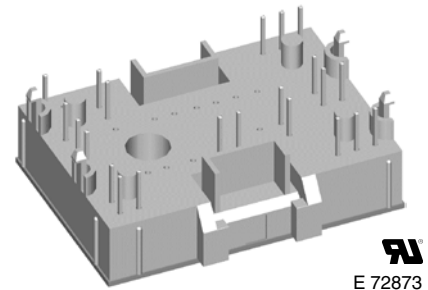
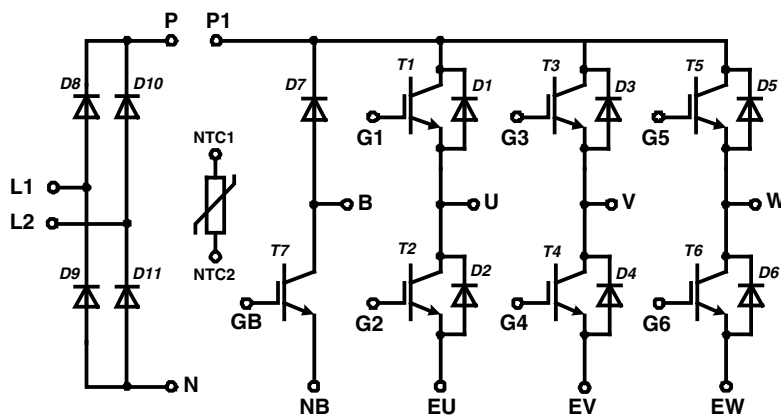

E 72873

Pin configuration see outlines.

### Features:

- High level of integration - only one power semiconductor module required for the whole drive
- Inverter with NPT IGBTs
  - low saturation voltage
  - positive temperature coefficient
  - fast switching
  - short tail current
- Epitaxial free wheeling diodes with hiperfast soft reverse recovery
- Temperature sense included

### Application:

- AC motor drives
- Pumps, Fans
- Washing machines
- Air-conditioning system
- Inverter and power supplies

### Package:

- "Mini" package
- Assembly height is 17 mm
- Insulated base plate
- Pins suitable for wave soldering and PCB mounting
- Assembly clips available
  - IXKU 5-505 screw clamp
  - IXRB 5-506 click clamp
- UL registered E72873

**Output Inverter T1 - T6**

Symbol	Definitions	Conditions	Ratings			Unit	
			min.	typ.	max.		
$V_{CES}$	collector emitter voltage		$T_{VJ} = 150^{\circ}\text{C}$		600	V	
$V_{GES}$	max. DC gate voltage	continuous			$\pm 20$	V	
$V_{GEM}$	max. transient collector gate voltage	transient			$\pm 30$	V	
$I_{C25}$	collector current		$T_C = 25^{\circ}\text{C}$		29	A	
$I_{C80}$			$T_C = 80^{\circ}\text{C}$		20	A	
$P_{tot}$	total power dissipation		$T_C = 25^{\circ}\text{C}$		100	W	
$V_{CE(sat)}$	collector emitter saturation voltage	$I_C = 20\text{ A}; V_{GE} = 15\text{ V}$	$T_{VJ} = 25^{\circ}\text{C}$ $T_{VJ} = 125^{\circ}\text{C}$	2.1 2.4	2.7	V V	
$V_{GE(th)}$	gate emitter threshold voltage	$I_C = 0.5\text{ A}; V_{GE} = V_{CE}$	$T_{VJ} = 25^{\circ}\text{C}$	4.5	5.5	6.5	V
$I_{CES}$	collector emitter leakage current	$V_{CE} = V_{CES}; V_{GE} = 0\text{ V}$	$T_{VJ} = 25^{\circ}\text{C}$ $T_{VJ} = 125^{\circ}\text{C}$		1.3	1.1 mA mA	
$I_{GES}$	gate emitter leakage current	$V_{GE} = \pm 20\text{ V}$			150	nA	
$C_{ies}$	input capacitance	$V_{CE} = 25\text{ V}; V_{GE} = 0\text{ V}; f = 1\text{ MHz}$			900	pF	
$Q_{G(on)}$	total gate charge	$V_{CE} = 300\text{ V}; V_{GE} = 15\text{ V}; I_C = 20\text{ A}$			76	nC	
$t_{d(on)}$	turn-on delay time	inductive load $V_{CE} = 300\text{ V}; I_C = 20\text{ A}$ $V_{GE} = \pm 15\text{ V}; R_G = 47\ \Omega$	$T_{VJ} = 25^{\circ}\text{C}$		35	ns	
$t_r$	current rise time				45	ns	
$t_{d(off)}$	turn-off delay time				155	ns	
$t_f$	current fall time				75	ns	
$E_{on}$	turn-on energy per pulse				0.39	mJ	
$E_{off}$	turn-off energy per pulse				0.4	mJ	
$t_{d(on)}$	turn-on delay time	inductive load $V_{CE} = 300\text{ V}; I_C = 20\text{ A}$ $V_{GE} = \pm 15\text{ V}; R_G = 47\ \Omega$	$T_{VJ} = 125^{\circ}\text{C}$		35	ns	
$t_r$	current rise time				45	ns	
$t_{d(off)}$	turn-off delay time				165	ns	
$t_f$	current fall time				150	ns	
$E_{on}$	turn-on energy per pulse				0.6	mJ	
$E_{off}$	turn-off energy per pulse				0.54	mJ	
<b>RBSOA</b>	reverse bias safe operating area	$V_{GE} = \pm 15\text{ V}; R_G = 47\ \Omega; I_C = 40\text{ A}$	$T_{VJ} = 125^{\circ}\text{C}$		$V_{CEK} \leq V_{CES} - L_S \cdot di/dt$	V	
<b><math>I_{SC}</math> (SCSOA)</b>	short circuit safe operating area	$V_{CE} = 360\text{ V}; V_{GE} = \pm 15\text{ V};$ $R_G = 47\ \Omega; t_p = 10\ \mu\text{s};$ non-repetitive	$T_{VJ} = 125^{\circ}\text{C}$		90	A	
$R_{thJC}$	thermal resistance junction to case	(per IGBT)			1.3	K/W	
$R_{thCH}$	thermal resistance case to heatsink			0.45		K/W	

**Output Inverter D1 - D6**

Symbol	Definitions	Conditions	Ratings			Unit
			min.	typ.	max.	
$V_{RRM}$	max. repetitive reverse voltage		$T_{VJ} = 150^{\circ}\text{C}$		600	V
$I_{F25}$	forward current		$T_C = 25^{\circ}\text{C}$		37	A
$I_{F80}$			$T_C = 80^{\circ}\text{C}$		24	A
$V_F$	forward voltage	$I_F = 20\text{ A}; V_{GE} = 0\text{ V}$	$T_{VJ} = 25^{\circ}\text{C}$ $T_{VJ} = 125^{\circ}\text{C}$	1.95 1.65	2.2	V V
$Q_{rr}$	reverse recovery charge	$V_R = 300\text{ V}$ $di_F/dt = -370\text{ A}/\mu\text{s}$ $I_F = 20\text{ A}; V_{GE} = 0\text{ V}$	$T_{VJ} = 125^{\circ}\text{C}$		0.58	$\mu\text{C}$
$I_{RM}$	max. reverse recovery current				10.7	A
$t_{rr}$	reverse recovery time				110	ns
$E_{rec}$	reverse recovery energy				60	$\mu\text{J}$
$R_{thJC}$	thermal resistance junction to case	(per diode)			1.6	K/W
$R_{thCH}$	thermal resistance case to heatsink			0.55		K/W

 $T_C = 25^{\circ}\text{C}$  unless otherwise stated

**Brake T7**

Symbol	Definitions	Conditions	Ratings			Unit	
			min.	typ.	max.		
$V_{CES}$	collector emitter voltage		$T_{VJ} = 150^{\circ}\text{C}$		600	V	
$V_{GES}$	max. DC gate voltage	continuous			$\pm 20$	V	
$V_{GEM}$	max. transient collector gate voltage	transient			$\pm 30$	V	
$I_{C25}$	collector current		$T_C = 25^{\circ}\text{C}$		29	A	
$I_{C80}$			$T_C = 80^{\circ}\text{C}$		20	A	
$P_{tot}$	total power dissipation		$T_C = 25^{\circ}\text{C}$		100	W	
$V_{CE(sat)}$	collector emitter saturation voltage	$I_C = 20\text{ A}; V_{GE} = 15\text{ V}$	$T_{VJ} = 25^{\circ}\text{C}$ $T_{VJ} = 125^{\circ}\text{C}$	2.1 2.4	2.7	V V	
$V_{GE(th)}$	gate emitter threshold voltage	$I_C = 0.5\text{ A}; V_{GE} = V_{CE}$	$T_{VJ} = 25^{\circ}\text{C}$	4.5	5.5	6.5	V
$I_{CES}$	collector emitter leakage current	$V_{CE} = V_{CES}; V_{GE} = 0\text{ V}$	$T_{VJ} = 25^{\circ}\text{C}$ $T_{VJ} = 125^{\circ}\text{C}$		0.8	1.0	mA mA
$I_{GES}$	gate emitter leakage current	$V_{GE} = \pm 20\text{ V}$			150	nA	
$C_{ies}$	input capacitance	$V_{CE} = 25\text{ V}; V_{GE} = 0\text{ V}; f = 1\text{ MHz}$			900	pF	
$Q_{G(on)}$	total gate charge	$V_{CE} = 300\text{ V}; V_{GE} = 15\text{ V}; I_C = 20\text{ A}$			76	nC	
$t_{d(on)}$	turn-on delay time	inductive load $V_{CE} = 300\text{ V}; I_C = 20\text{ A}$ $V_{GE} = \pm 15\text{ V}; R_G = 47\ \Omega$	$T_{VJ} = 25^{\circ}\text{C}$		35	ns	
$t_r$	current rise time				45	ns	
$t_{d(off)}$	turn-off delay time				155	ns	
$t_f$	current fall time				75	ns	
$E_{on}$	turn-on energy per pulse				0.39	mJ	
$E_{off}$	turn-off energy per pulse				0.4	mJ	
$t_{d(on)}$	turn-on delay time	inductive load $V_{CE} = 300\text{ V}; I_C = 20\text{ A}$ $V_{GE} = \pm 15\text{ V}; R_G = 47\ \Omega$	$T_{VJ} = 125^{\circ}\text{C}$		35	ns	
$t_r$	current rise time				45	ns	
$t_{d(off)}$	turn-off delay time				165	ns	
$t_f$	current fall time				150	ns	
$E_{on}$	turn-on energy per pulse				0.6	mJ	
$E_{off}$	turn-off energy per pulse				0.54	mJ	
<b>RBSOA</b>	reverse bias safe operating area	$V_{GE} = \pm 15\text{ V}; R_G = 47\ \Omega; I_C = 40\text{ A}$	$T_{VJ} = 125^{\circ}\text{C}$		$V_{CEK} \leq V_{CES} - L_S \cdot di/dt$	V	
<b><math>I_{SC}</math> (SCSOA)</b>	short circuit safe operating area	$V_{CE} = 360\text{ V}; V_{GE} = \pm 15\text{ V};$ $R_G = 47\ \Omega; t_p = 10\ \mu\text{s};$ non-repetitive	$T_{VJ} = 125^{\circ}\text{C}$		90	A	
$R_{thJC}$	thermal resistance junction to case	(per IGBT)			1.3	K/W	
$R_{thCH}$	thermal resistance case to heatsink			0.45		K/W	

**Brake Chopper D7**

Symbol	Definitions	Conditions	Ratings			Unit
			min.	typ.	max.	
$V_{RRM}$	max. repetitive reverse voltage		$T_{VJ} = 150^{\circ}\text{C}$		600	V
$I_{F25}$	forward current		$T_C = 25^{\circ}\text{C}$		37	A
$I_{F80}$			$T_C = 80^{\circ}\text{C}$		24	A
$V_F$	forward voltage	$I_F = 20\text{ A}; V_{GE} = 0\text{ V}$	$T_{VJ} = 25^{\circ}\text{C}$ $T_{VJ} = 125^{\circ}\text{C}$	1.95 1.65	2.2	V V
$I_R$	reverse current	$V_R = V_{RRM}$	$T_{VJ} = 25^{\circ}\text{C}$ $T_{VJ} = 125^{\circ}\text{C}$		0.1	mA mA
$Q_{rr}$	reverse recovery charge	$V_R = 300\text{ V}$ $di_F/dt = -370\text{ A}/\mu\text{s}$ $I_F = 20\text{ A}; V_{GE} = 0\text{ V}$	$T_{VJ} = 125^{\circ}\text{C}$		0.58	$\mu\text{C}$
$I_{RM}$	max. reverse recovery current				10.7	A
$t_{rr}$	reverse recovery time				110	ns
$E_{rec}$	reverse recovery energy				60	$\mu\text{J}$
$R_{thJC}$	thermal resistance junction to case	(per diode)			1.6	K/W
$R_{thCH}$	thermal resistance case to heatsink			0.55		K/W

 $T_C = 25^{\circ}\text{C}$  unless otherwise stated

IXYS reserves the right to change limits, test conditions and dimensions.

20080326b

**Input Rectifier Bridge D8 - D11**

Symbol	Definitions	Conditions	Ratings			Unit
			min.	typ.	max.	
$V_{RRM}$	max. repetitive reverse voltage				1600	V
$I_{FAV}$	average forward current	sine 180°			39	A
$I_{DAVM}$	max. average DC output current	rect.; d = 1/2			42	A
$I_{FSM}$	max. forward surge current	t = 10 ms; sine 50 Hz			550	A
					tbd	A
$I^2t$	I <sup>2</sup> t value for fusing	t = 10 ms; sine 50 Hz			1270	A <sup>2</sup> s
					tbd	A <sup>2</sup> s
$P_{tot}$	total power dissipation				100	W
$V_F$	forward voltage	$I_F = 30$ A		1.2	1.5	V
				1.3		V
$I_R$	reverse current	$V_R = V_{RRM}$		0.3	0.03	mA
						mA
$R_{thJC}$	thermal resistance junction to case	(per diode)		0.4	1.2	K/W
$R_{thCH}$	thermal resistance case to heatsink	(per diode)				K/W

**Temperature Sensor NTC**

Symbol	Definitions	Conditions	Ratings			Unit
			min.	typ.	max.	
$R_{25}$	resistance		4.75	5.0	5.25	kΩ
$B_{25/50}$				3375		K

**Module**

Symbol	Definitions	Conditions	Ratings			Unit
			min.	typ.	max.	
$T_{VJ}$	operating temperature		-40		125	°C
$T_{VJM}$	max. virtual junction temperature				150	°C
$T_{stg}$	storage temperature		-40		125	°C
$V_{ISOL}$	isolation voltage	$I_{ISOL} \leq 1$ mA; 50/60 Hz			2500	V~
<b>CTI</b>	comparative tracking index			-		
$F_C$	mounting force		40		80	N
$d_S$	creep distance on surface		12.7			mm
$d_A$	strike distance through air		12			mm
<b>Weight</b>				35		g

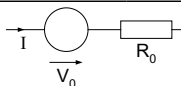
**Equivalent Circuits for Simulation**

Symbol	Definitions	Conditions	Ratings			Unit
			min.	typ.	max.	
$V_0$	rectifier diode	D8 - D11		0.9		V
$R_0$				6		mΩ
$V_0$	IGBT	T1 - T6		1.1		V
$R_0$				40		mΩ
$V_0$	free wheeling diode	D1 - D6		1.25		V
$R_0$				12		mΩ
$V_0$	IGBT	T7		1.1		V
$R_0$				60		mΩ
$V_0$	free wheeling diode	D7		1.25		V
$R_0$				25		mΩ

IXYS reserves the right to change limits, test conditions and dimensions.

 $T_C = 25^\circ\text{C}$  unless otherwise stated

20080326b

### Circuit Diagram

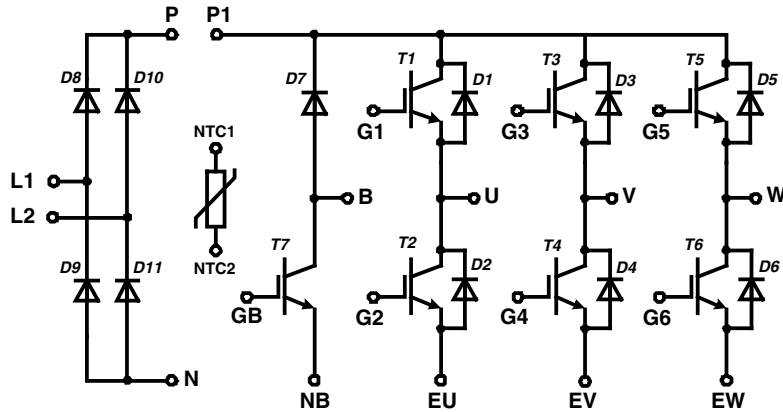

### Outline Drawing

Dimensions in mm (1 mm = 0.0394")

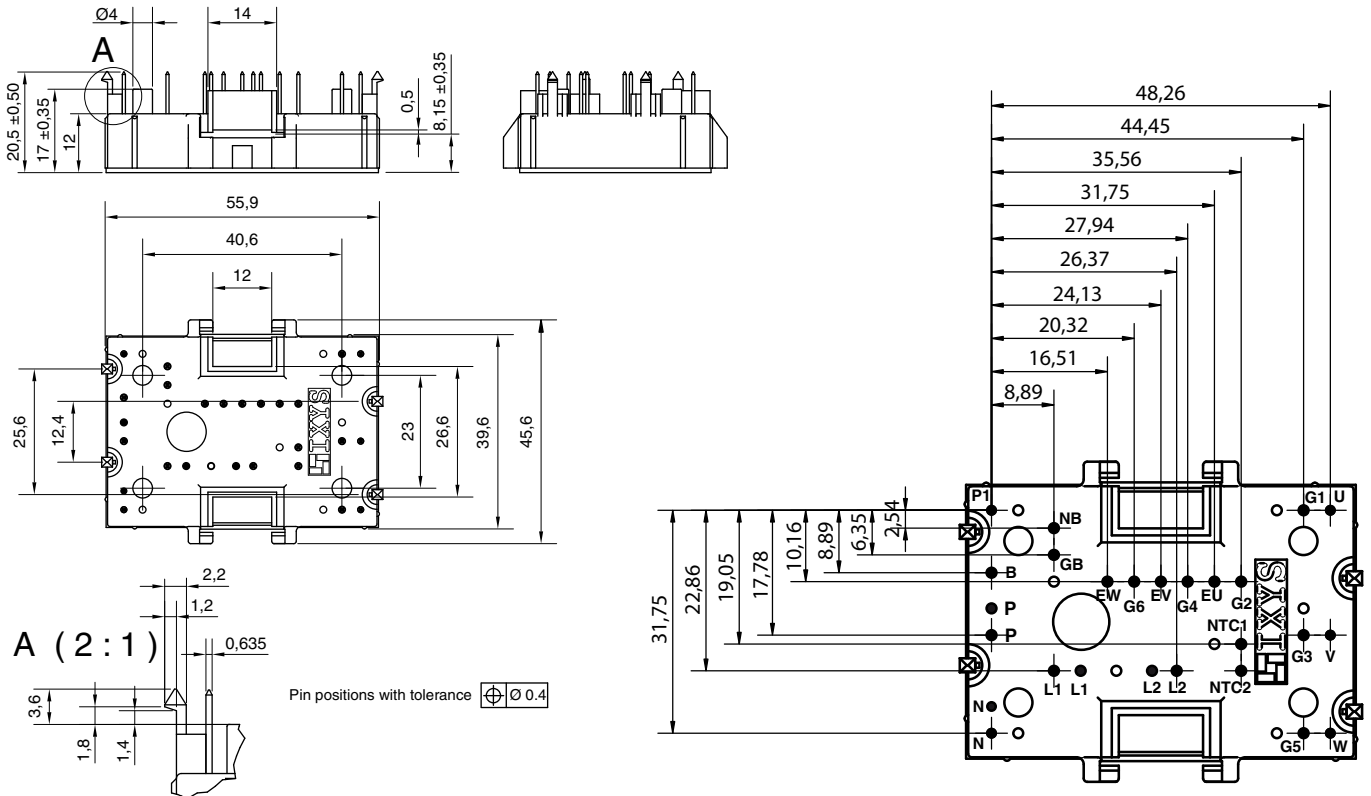

### Product Marking

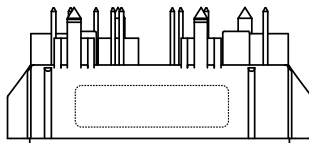

#### Part number

- M = Module
- I = IGBT
- A = IGBT (NPT)
- A = Gen 1 / std
- 20 = Current Rating [A]
- WE = 6-Pack + 1~ Rectifier Bridge & Brake Unit
- 600 = Reverse Voltage [V]
- T = NTC
- MH = MiniPack2

Ordering	Part Name	Marking on Product	Delivering Mode	Base Qty	Ordering Code
Standard	MIAA 20 WE 600 TMH	MIAA20WE600TMH	Box	20	504708

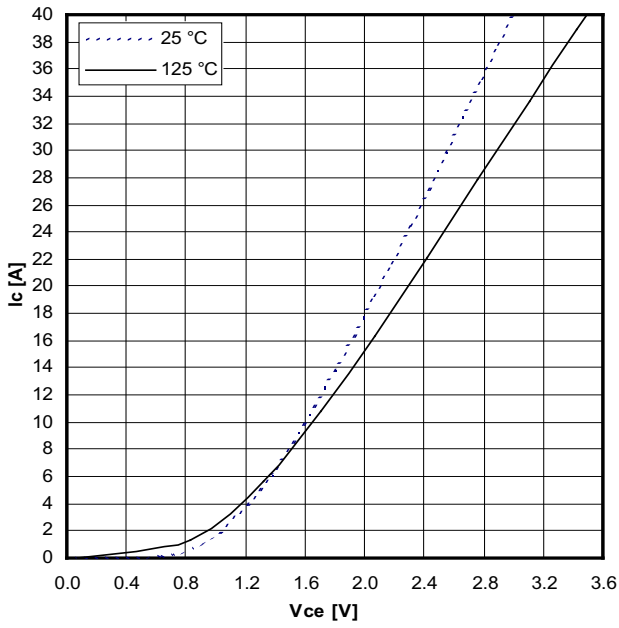

Typical output characteristics,  $V_{GE} = 15\text{ V}$

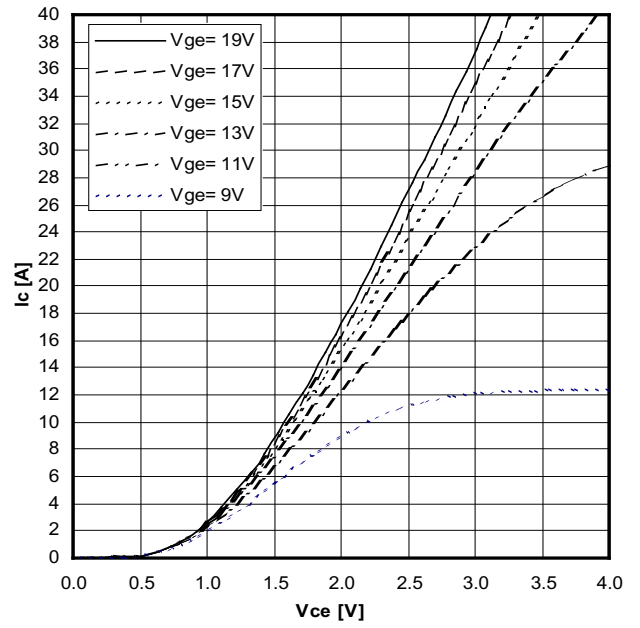

Typical output characteristics (125°C)

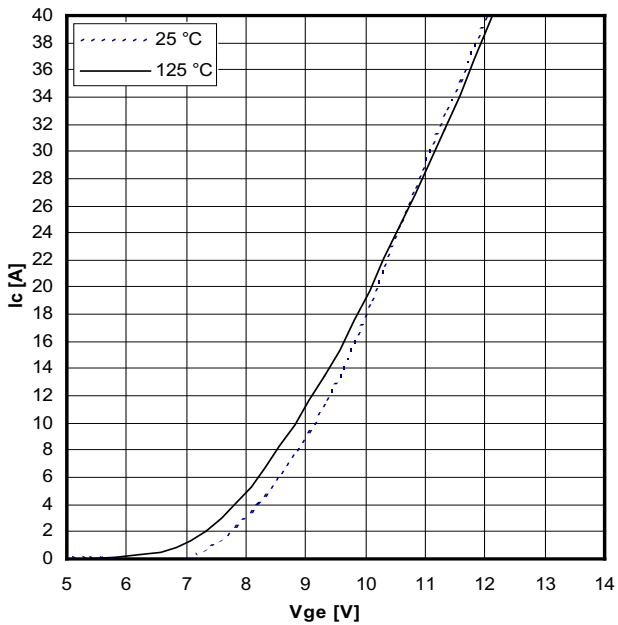

Typical transfer characteristics

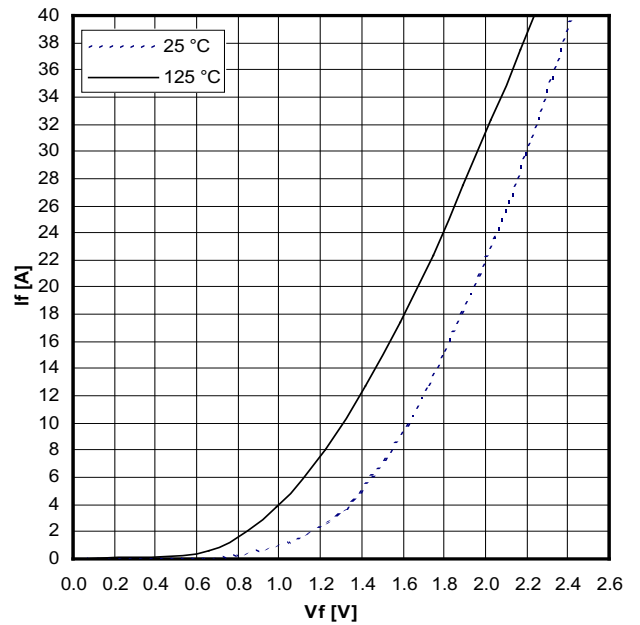

Typical forward characteristics of freewheeling diode

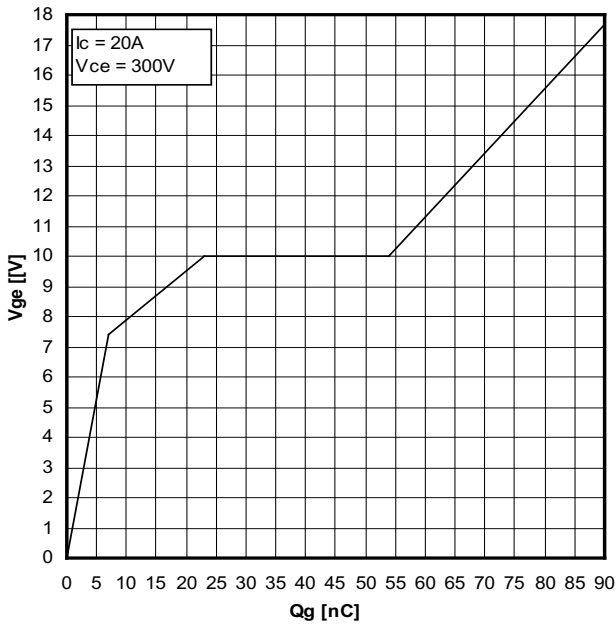

Typical turn on gate charge

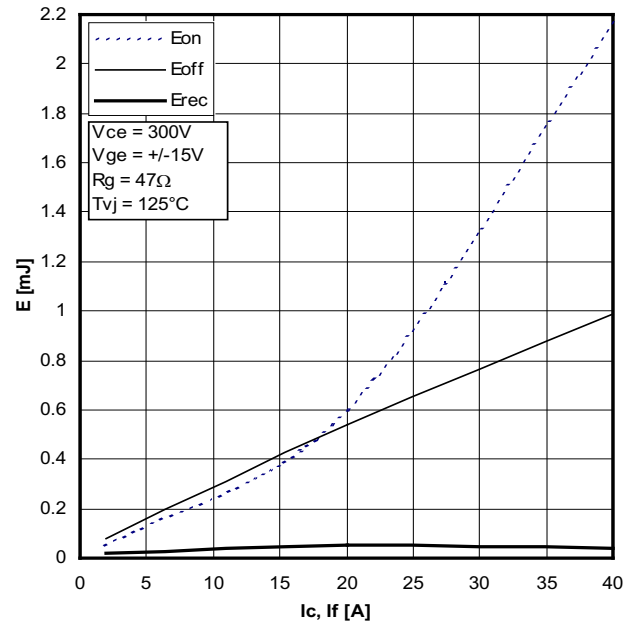

Typical switching energy versus collector current

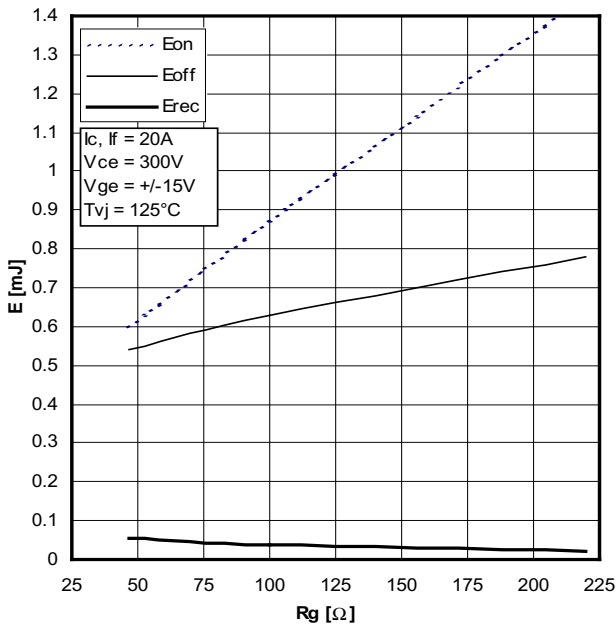

Typical switching energy versus gate resistance

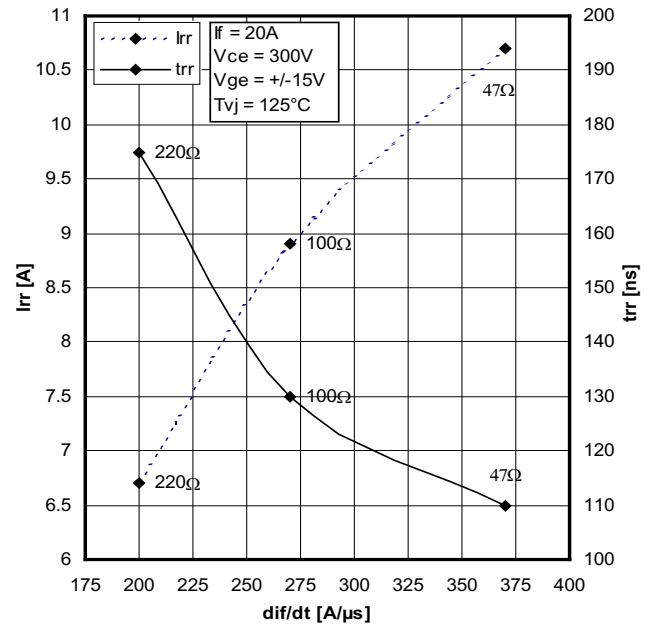

Typical turn-off characteristics of free wheeling diode

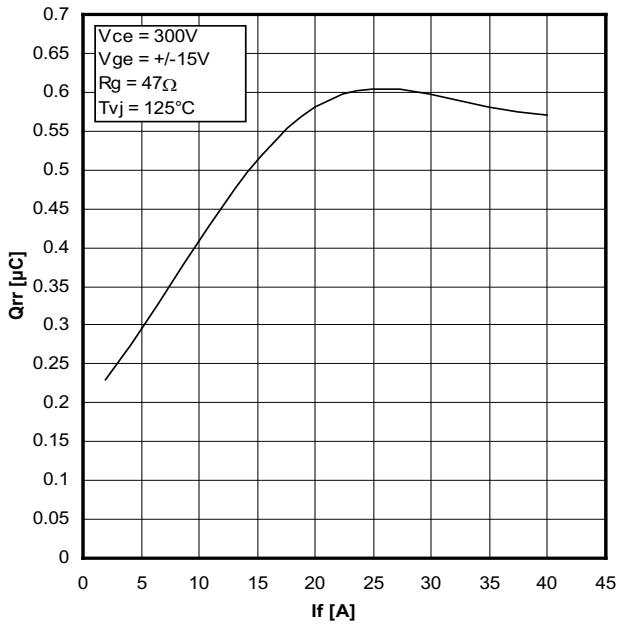

Typical turn-off characteristics of free wheeling diode

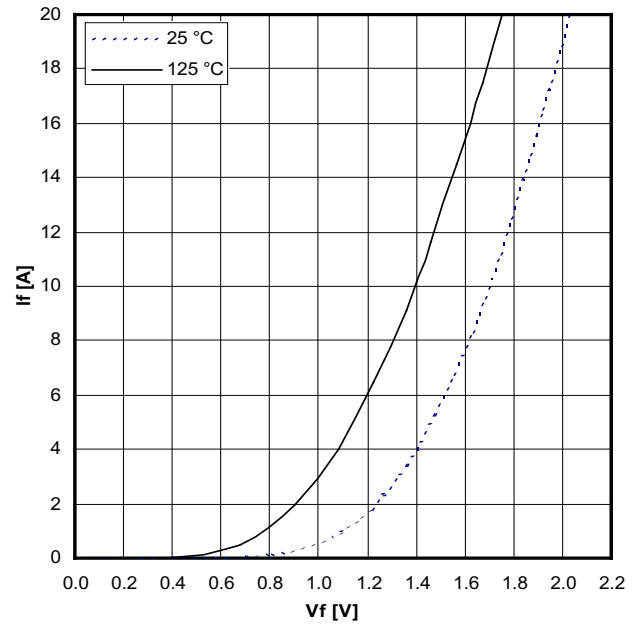

Typical forward characteristics of brake diode

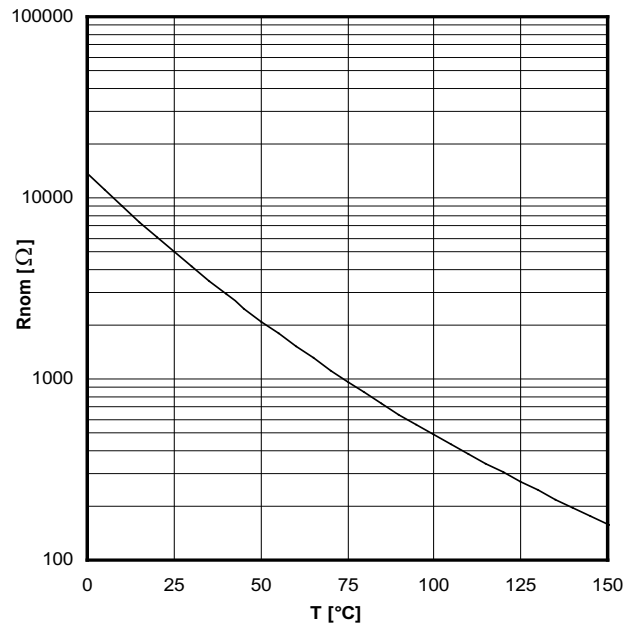

Typical thermistor resistance versus temperature