

28V Synchronous Buck Controllers Featuring Adaptive ON-Time Control

Features

- Hyper Speed Control Architecture Enables:
 - High delta V operation ($V_{IN} = 28V$ and $V_{OUT} = 0.6V$)
 - Any Capacitor™ stable
- 4.5V to 28V Input Voltage
- Adjustable Output Voltage from 0.6V to 24V
- 200 kHz to 750 kHz Programmable Switching Frequency
- HyperLight Load® (MIC2125)
- Hyper Speed Control® (MIC2126)
- Enable Input and Power Good Output
- Built-in 5V Regulator for Single-Supply Operation
- Programmable current limit and “hiccup” mode short-circuit protection
- 7 ms internal soft-start, internal compensation, and thermal shutdown
- Supports Safe Start-Up into a Prebiased Output
- $-40^{\circ}C$ to $+125^{\circ}C$ Junction Temperature Range
- Available in 16-pin, 3 mm x 3 mm QFN Package

Applications

- Networking/Telecom Equipment
- Base Stations, Servers
- Distributed Power Systems
- Industrial Power Supplies

General Description

The MIC2125 and MIC2126 are constant-frequency synchronous buck controllers featuring a unique adaptive ON-time control architecture. The MIC2125/6 operate over an input voltage range from 4.5V to 28V and can be used to supply load current up to 25A. The output voltage is adjustable down to 0.6V with a guaranteed accuracy of $\pm 1\%$. The device operates with programmable switching frequency from 200 kHz to 750 kHz.

HyperLight Load® architecture provides the same high efficiency and ultra-fast transient response as the Hyper Speed Control® architecture under medium to heavy loads. It also maintains high efficiency under light load conditions by transitioning to variable frequency, discontinuous conduction mode operation.

The MIC2125/6 offer a full suite of features to ensure protection of the IC during fault conditions. These include undervoltage lockout to ensure proper operation under power-sag conditions, internal soft-start to reduce inrush current, “hiccup” mode short-circuit protection, and thermal shutdown.

Package Type

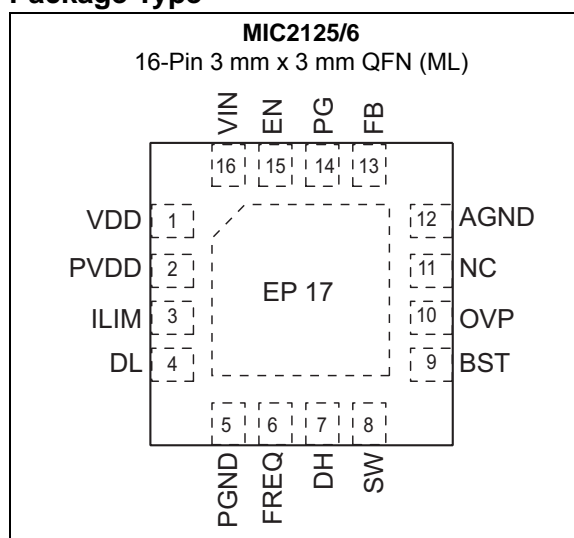

MIC2125/6

Typical Application Circuit

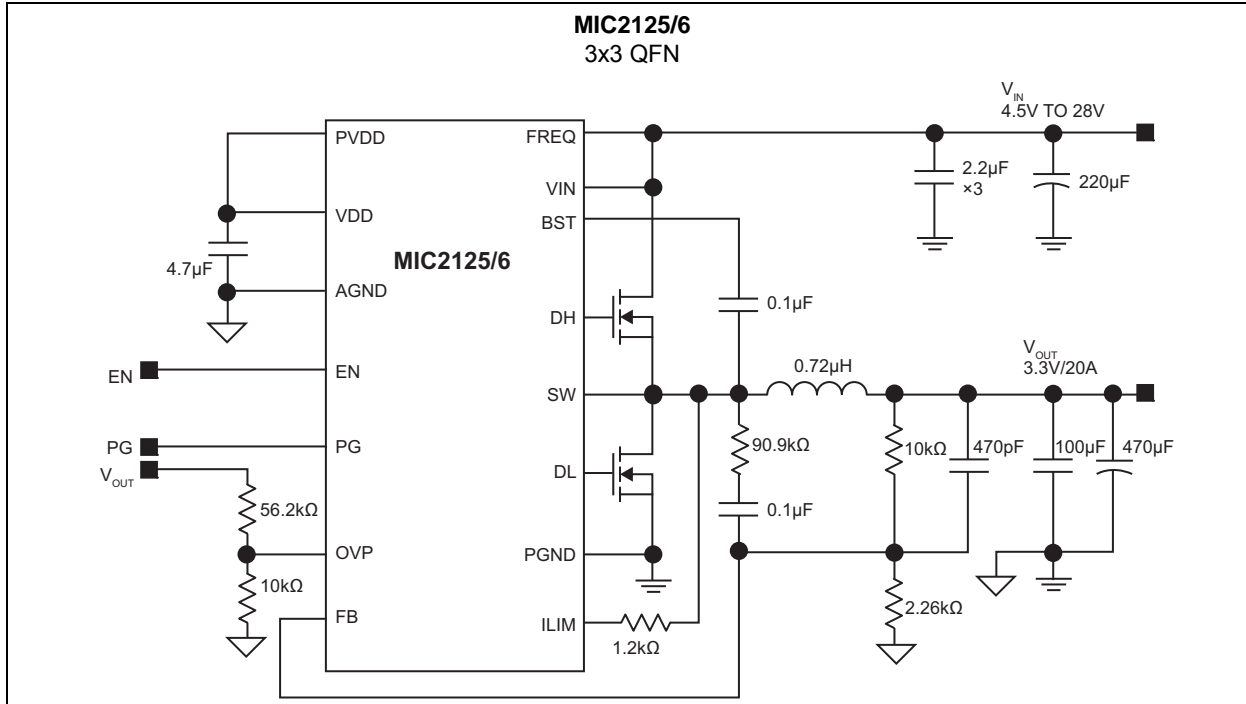

Functional Block Diagram

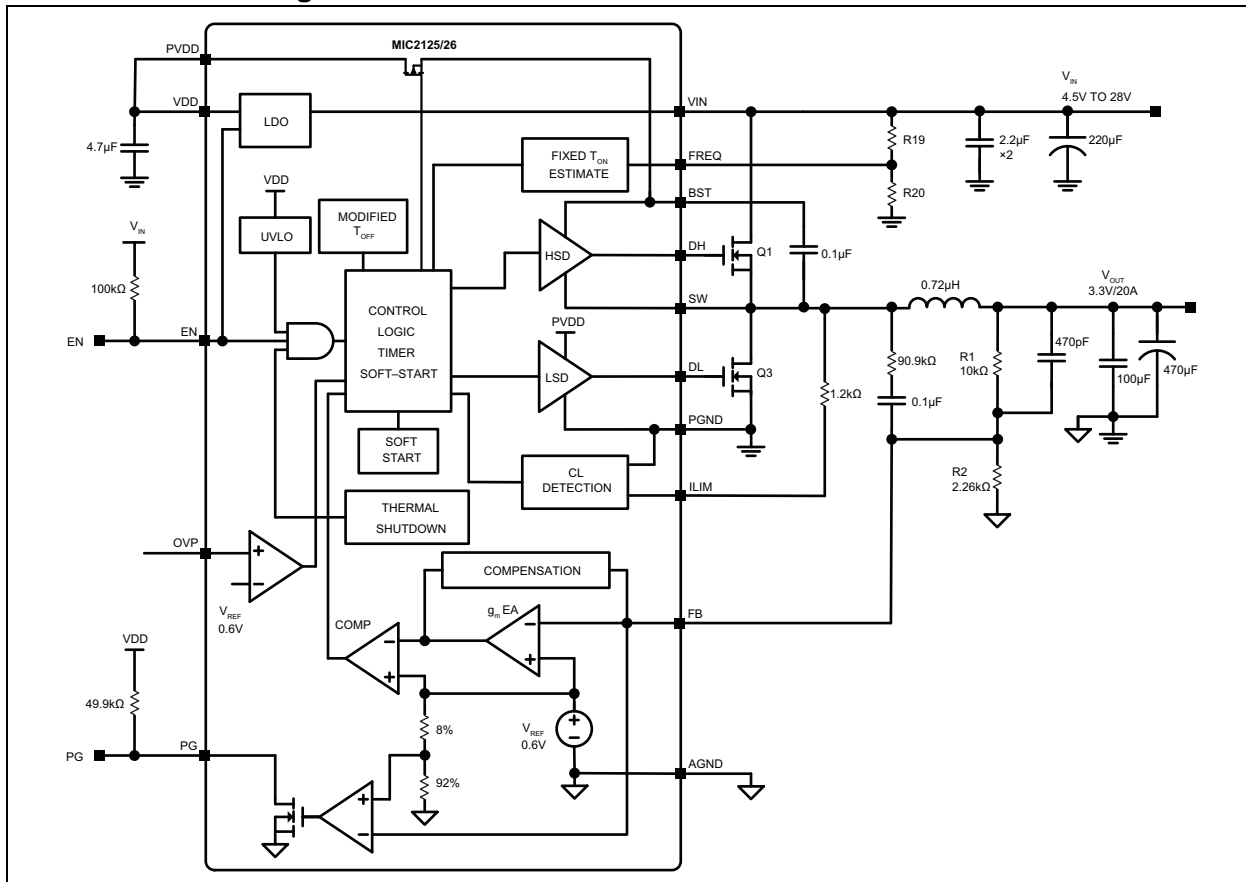

1.0 ELECTRICAL CHARACTERISTICS

Absolute Maximum Ratings †

V_{IN}	-0.3V to +30V
V_{DD} , P_{VDD}	-0.3V to +6V
V_{SW} , V_{FREQ} , V_{ILIM} , V_{EN}	-0.3V to ($V_{IN} + 0.3V$)
V_{BST} to V_{SW}	-0.3V to 6V
V_{BST}	-0.3V to 36V
V_{PG}	-0.3V to ($V_{DD} + 0.3V$)
V_{FB}	-0.3V to ($V_{DD} + 0.3V$)
P_{GND} to A_{GND}	-0.3V to +0.3V
ESD Rating ⁽¹⁾	2 kV

Operating Ratings ‡

Supply Voltage (V_{IN}).....	4.5V to 28V
V_{SW} , V_{FREQ} , V_{ILIM} , V_{EN}	0V to V_{IN}

† **Notice:** Stresses above those listed under “Absolute Maximum Ratings” may cause permanent damage to the device. This is a stress rating only and functional operation of the device at those or any other conditions above those indicated in the operational sections of this specification is not intended. Exposure to maximum rating conditions for extended periods may affect device reliability.

‡ **Notice:** The device is not guaranteed to function outside its operating ratings.

Note 1: Devices are ESD sensitive. Handling precautions are recommended. Human body model, 1.5 k Ω in series with 100 pF.

MIC2125/6

TABLE 1-1: ELECTRICAL CHARACTERISTICS

Electrical Characteristics: $V_{IN} = 12V$, $V_{OUT} = 1.2V$, $V_{BST} - V_{SW} = 5V$; $T_A = 25^\circ C$, unless noted. **Bold** values indicate $-40^\circ C \leq T_J \leq +125^\circ C$. (**Note 1**).

Parameters	Min.	Typ.	Max.	Units	Conditions
Power Supply Input					
Input Voltage Range (V_{IN}) (Note 2)	4.5	—	5.5	V	$V_{DD} = V_{IN}$
	4.5	—	28		—
Quiescent Supply Current (MIC2125)	—	340	750	μA	$V_{FB} = 1.5V$
Quiescent Supply Current (MIC2126)	—	1.1	3	mA	$V_{FB} = 1.5V$
Shutdown Supply Current	—	0.1	5	μA	SW unconnected, $V_{EN} = 0V$
V_{DD} Supply					
V_{DD} Output Voltage	4.8	5.2	5.4	V	$V_{IN} = 7V$ to $28V$, $I_{DD} = 10$ mA
V_{DD} UVLO Threshold	3.7	4.2	4.5		V_{DD} rising
V_{DD} UVLO Hysteresis	—	400	—	mV	—
Load Regulation	0.6	2	3.6	%	$I_{DD} = 0$ to 40 mA
Reference					
Feedback Reference Voltage	0.597	0.6	0.603	V	$T_J = 25^\circ C$ ($\pm 0.5\%$)
	0.594	0.6	0.606		$-40^\circ C \leq T_J \leq +125^\circ C$ ($\pm 1\%$)
FB Bias Current	—	0.01	0.5	μA	$V_{FB} = 0.6V$
Enable Control					
EN Logic Level High	1.6	—	—	V	—
EN Logic Level Low	—	—	0.6		—
EN Hysteresis	—	120	—	mV	—
EN Bias Current	—	6	30	μA	$V_{EN} = 12V$
Oscillator					
Switching Frequency	—	750	—	kHz	$V_{FREQ} = V_{IN}$
	—	375	—		$V_{FREQ} = 50\% \times V_{IN}$
Maximum Duty Cycle	—	85	—	%	—
Minimum Duty Cycle	—	0	—		$V_{FB} > 0.6V$
Minimum On-Time	—	100	—	ns	—
Minimum Off-Time	150	220	300		—
Soft-Start					
Soft-Start Time	—	7	—	ms	—
Short-Circuit Protection and OVP					
Current-Limit Comparator Offset	-15	-4	7	mV	$V_{FB} = 0.6V$
Current-Limit Source Current	32	36	40	μA	$V_{FB} = 0.6V$

Note 1: Specification for packaged product only.

2: The application is fully functional at low V_{DD} (supply of the control section) if the external MOSFETs have low voltage V_{TH} .

TABLE 1-1: ELECTRICAL CHARACTERISTICS (CONTINUED)

Electrical Characteristics: $V_{IN} = 12V$, $V_{OUT} = 1.2V$, $V_{BST} - V_{SW} = 5V$; $T_A = 25^\circ C$, unless noted. Bold values indicate $-40^\circ C \leq T_J \leq +125^\circ C$. (Note 1).					
Parameters	Min.	Typ.	Max.	Units	Conditions
Overvoltage Protection Threshold	—	0.62	—	V	—
FET Drivers					
DH, DL Output Low Voltage	—	—	0.1	V	$I_{SINK} = 10\text{ mA}$
DH, DL Output High Voltage	$V_{PVDD}-0.1$ or $V_{BST}-0.1$	—	—		$I_{SOURCE} = 10\text{ mA}$
DH On-Resistance, High State	—	2.5	—	Ω	—
DH On-Resistance, Low State	—	1.6	—		—
DL On-Resistance, High State	—	1.9	—		—
DL On-Resistance, Low State	—	0.55	—		—
SW, BST Leakage Current	—	—	50	μA	—
Power Good (PG)					
PG Threshold Voltage	85	89	95	$\%V_{OUT}$	Sweep V_{FB} from low to high
PG Hysteresis	—	6	—		Sweep V_{FB} from high to low
PG Delay Time	—	80	—	μs	Sweep V_{FB} from low to high
PG Low Voltage	—	60	200	mV	$V_{FB} < 90\% \times V_{NOM}$, $I_{PG} = 1\text{ mA}$
Thermal Protection					
Overtemperature Shutdown	—	150	—	$^\circ C$	T_J Rising
Overtemperature Shutdown Hysteresis	—	15	—	$^\circ C$	—

Note 1: Specification for packaged product only.

2: The application is fully functional at low V_{DD} (supply of the control section) if the external MOSFETs have low voltage V_{TH} .

MIC2125/6

TEMPERATURE SPECIFICATIONS

Parameters	Sym.	Min.	Typ.	Max.	Units	Conditions
Temperature Ranges						
Junction Operating Temperature	T_J	-40	—	+125	°C	Note 1
Storage Temperature Range	T_S	-65	—	+150	°C	—
Junction Temperature	T_J	—	—	+150	°C	—
Lead Temperature	—	—	—	+260	°C	Soldering, 10s
Package Thermal Resistances						
Thermal Resistance 3 mm x 3 mm QFN-16LD	θ_{JA}	—	50.8	—	°C/W	—
	θ_{JC}	—	25.3	—	°C/W	—

Note 1: The maximum allowable power dissipation is a function of ambient temperature, the maximum allowable junction temperature and the thermal resistance from junction to air (i.e., T_A , T_J , θ_{JA}). Exceeding the maximum allowable power dissipation will cause the device operating junction temperature to exceed the maximum +125°C rating. Sustained junction temperatures above +125°C can impact the device reliability.

2.0 TYPICAL PERFORMANCE CURVES

Note: The graphs and tables provided following this note are a statistical summary based on a limited number of samples and are provided for informational purposes only. The performance characteristics listed herein are not tested or guaranteed. In some graphs or tables, the data presented may be outside the specified operating range (e.g., outside specified power supply range) and therefore outside the warranted range.

Note: Unless otherwise noted, $V_{IN} = 12V$, $FREQ = 350\text{ kHz}$.

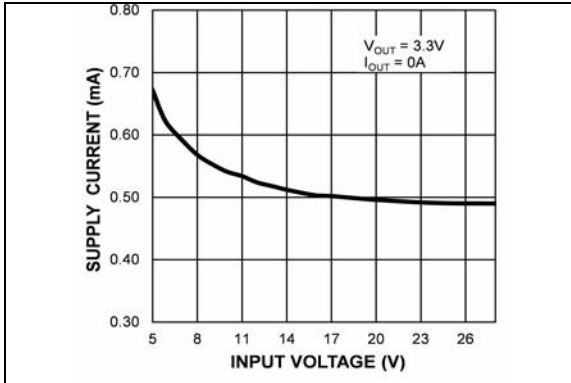

FIGURE 2-1: V_{IN} Operating Supply Current vs. Input Voltage (MIC2125).

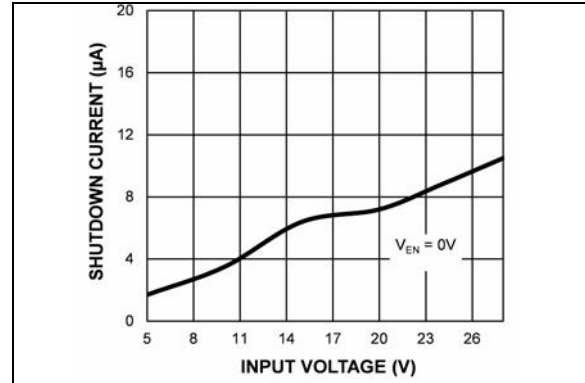

FIGURE 2-4: V_{IN} Shutdown Current vs. Input Voltage (MIC2125).

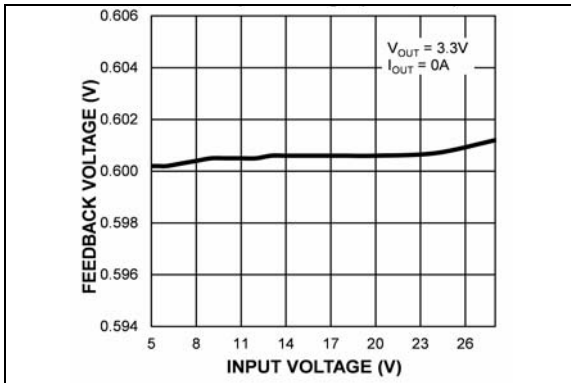

FIGURE 2-2: Feedback Voltage vs. Input Voltage (MIC2125).

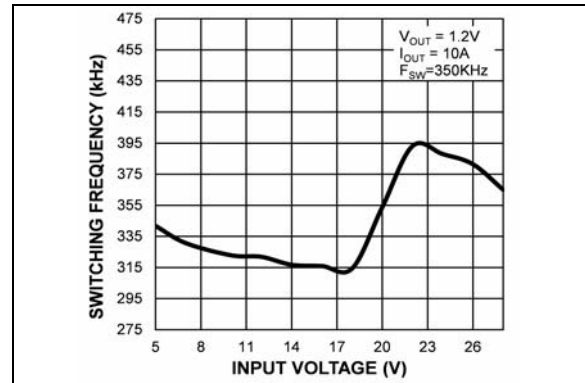

FIGURE 2-5: Switching Frequency vs. Input Voltage.

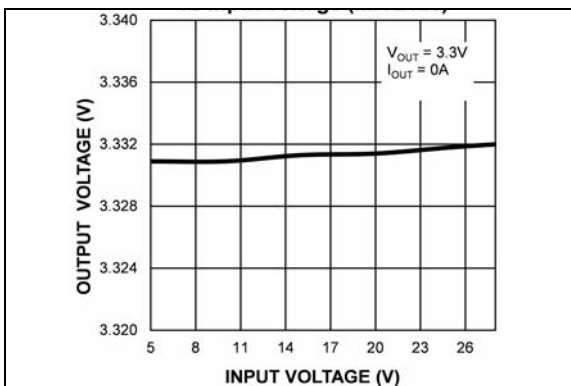

FIGURE 2-3: Output Voltage vs. Input Voltage (MIC2125).

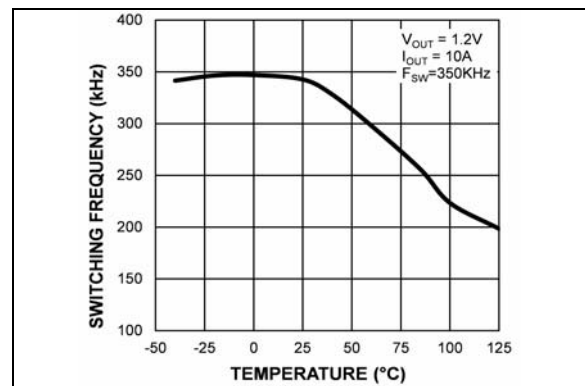

FIGURE 2-6: Switching Frequency vs. Temperature (MIC2126).

MIC2125/6

Note: Unless otherwise noted, $V_{IN} = 12V$, FREQ = 350 kHz.

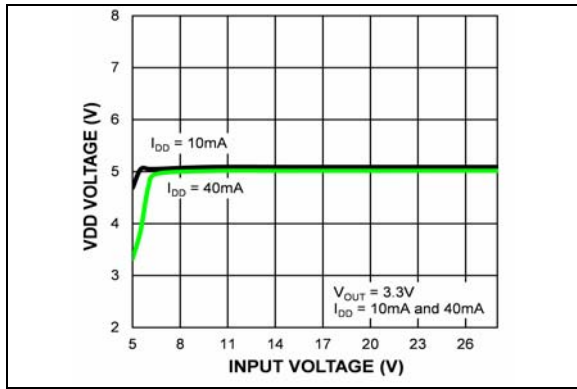

FIGURE 2-7: V_{DD} Voltage vs. Input Voltage (MIC2125).

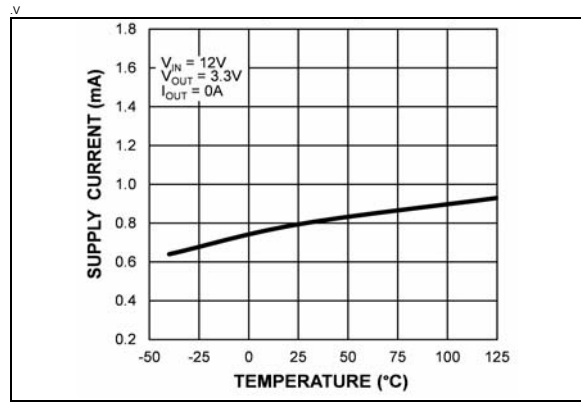

FIGURE 2-10: V_{IN} Operating Supply Current vs. Temperature (MIC2125).

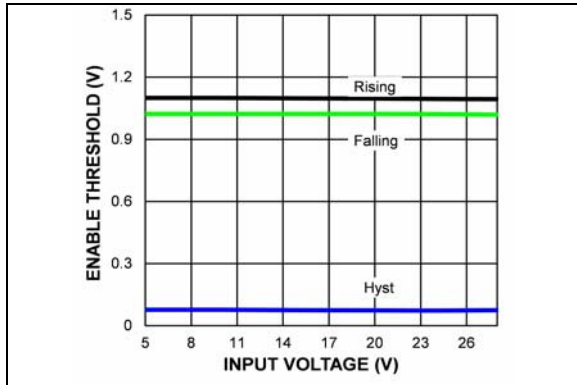

FIGURE 2-8: Enable Threshold vs. Input Voltage (MIC2125).

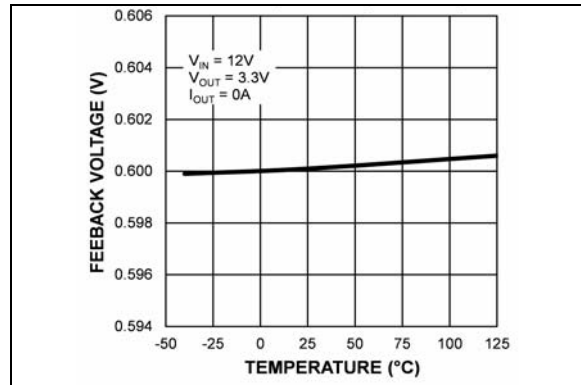

FIGURE 2-11: Feedback Voltage vs. Temperature (MIC2125).

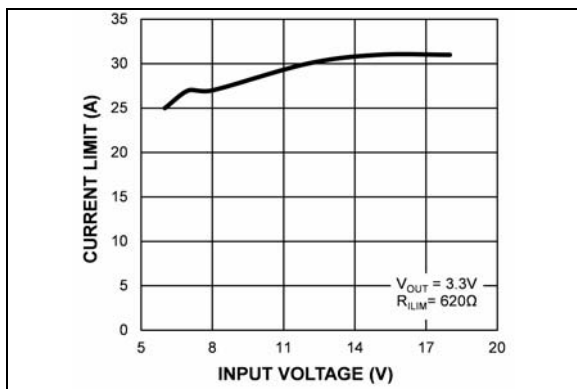

FIGURE 2-9: Output Peak Current Limit vs. Input Voltage (MIC2125).

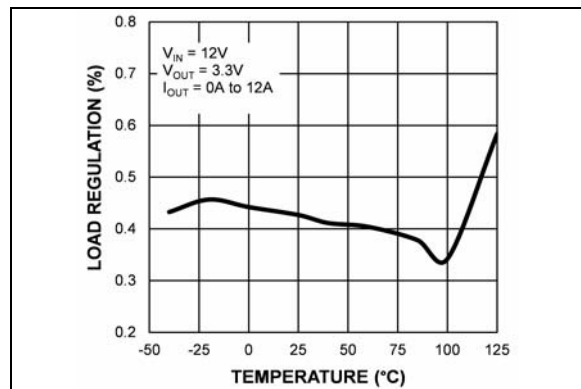

FIGURE 2-12: Load Regulation vs. Temperature (MIC2125).

Note: Unless otherwise noted, $V_{IN} = 12V$, $FREQ = 350\text{ kHz}$.

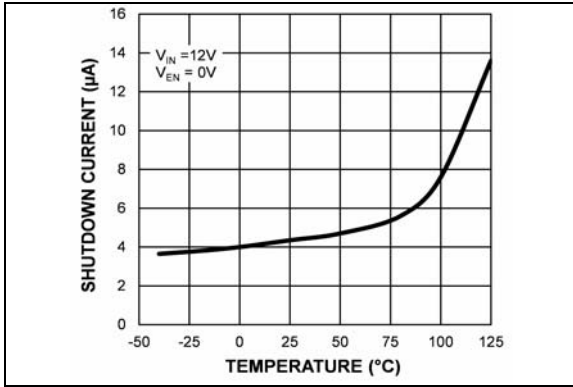

FIGURE 2-13: V_{IN} Shutdown Current vs. Temperature (MIC2125).

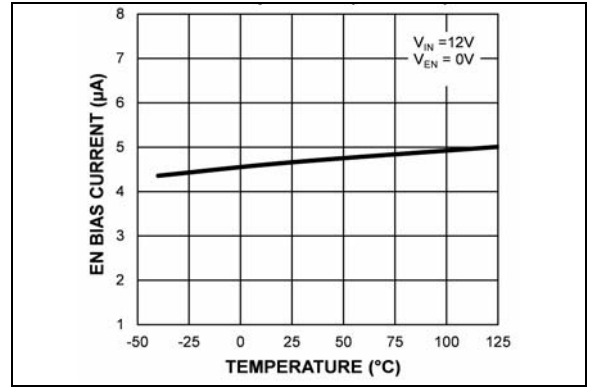

FIGURE 2-16: EN Bias Current vs. Temperature (MIC2125).

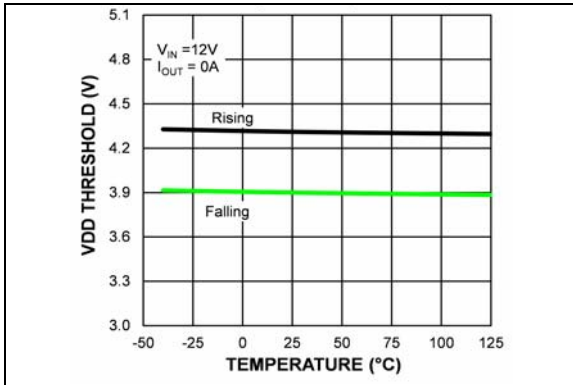

FIGURE 2-14: V_{DD} UVLO Threshold vs. Temperature (MIC2125).

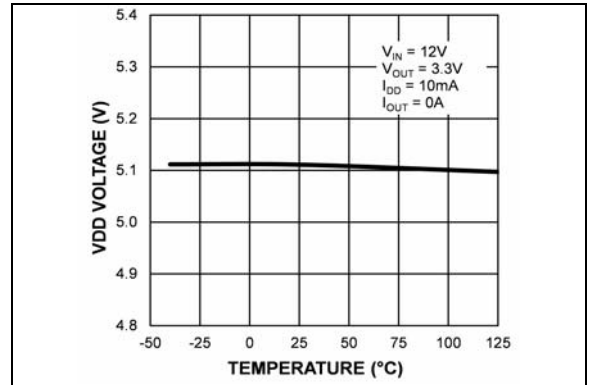

FIGURE 2-17: V_{DD} Voltage vs. Temperature (MIC2125).

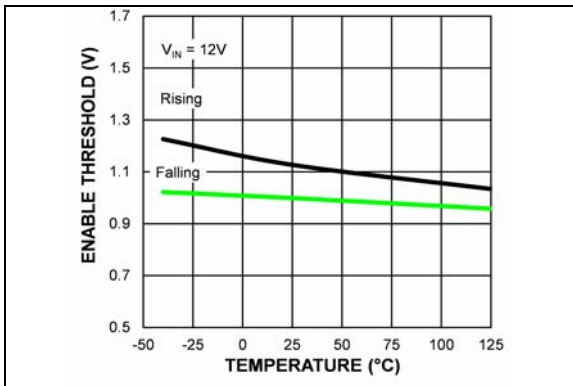

FIGURE 2-15: Enable Threshold vs. Temperature (MIC2125).

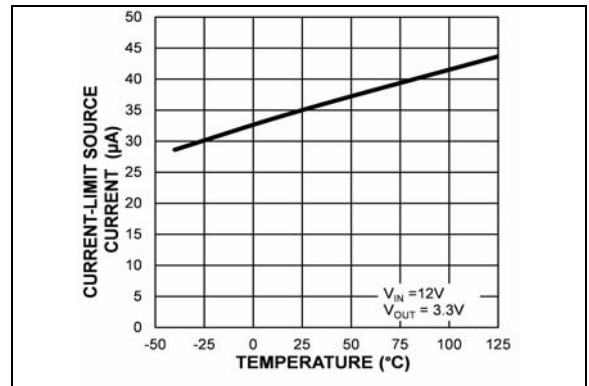

FIGURE 2-18: Current-Limit Source Current vs. Temperature (MIC2125).

MIC2125/6

Note: Unless otherwise noted, $V_{IN} = 12V$, $FREQ = 350\text{ kHz}$.

***Note:** For Case Temperature graphs: The temperature measurement was taken at the hottest point on the MIC2125/6 case mounted on a 5 square inch PCBn. Actual results will depend upon the size of the PCB, ambient temperature and proximity to other heat emitting components.

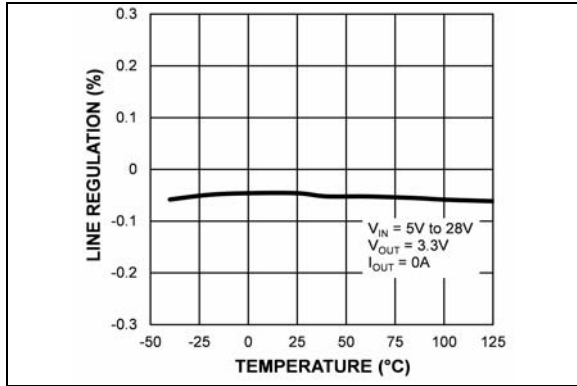

FIGURE 2-19: Line Regulation vs. Temperature (MIC2125).

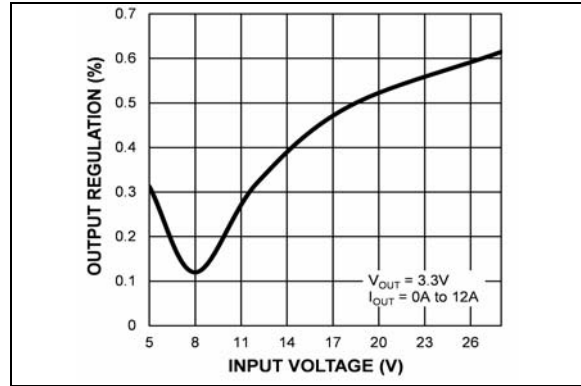

FIGURE 2-22: Output Regulation vs. Input Voltage (MIC2125).

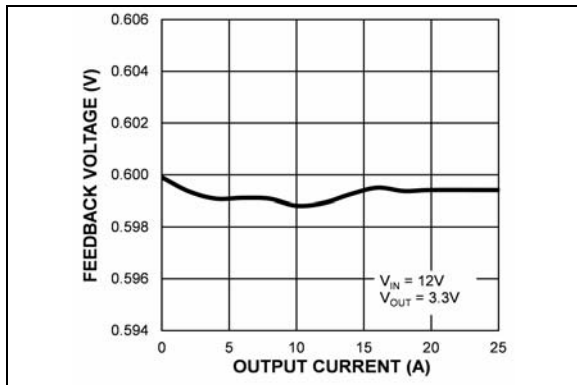

FIGURE 2-20: Feedback Voltage vs. Output Current (MIC2125).

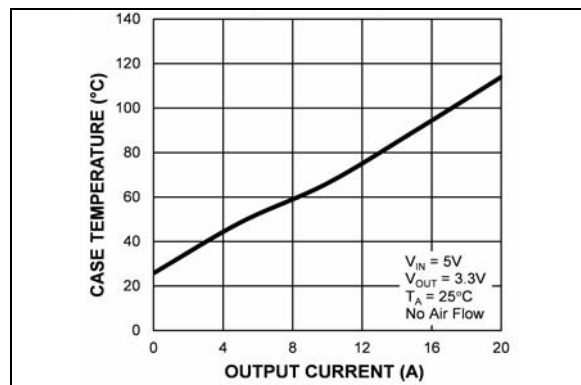

FIGURE 2-23: Case Temperature* vs. Output Current (MIC2125).

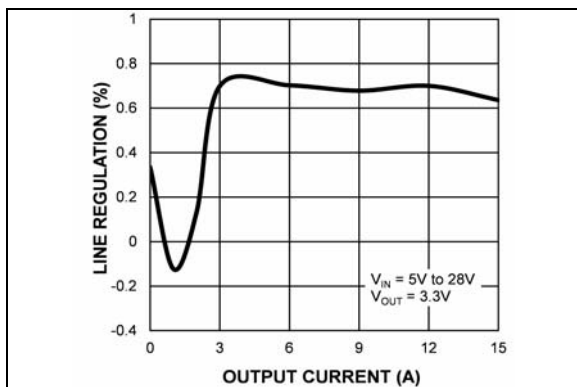

FIGURE 2-21: Line Regulation vs. Output Current (MIC2125).

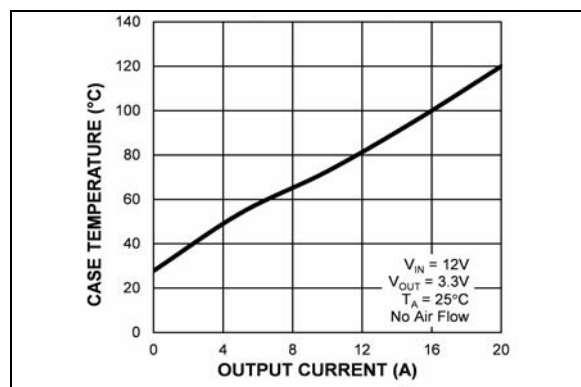

FIGURE 2-24: Case Temperature* vs. Output Current (MIC2125).

Note: Unless otherwise noted, $V_{IN} = 12V$, $FREQ = 350\text{ kHz}$.

***Note:** For Case Temperature graphs: The temperature measurement was taken at the hottest point on the MIC2125/6 case mounted on a 5 square inch PCBn. Actual results will depend upon the size of the PCB, ambient temperature and proximity to other heat emitting components.

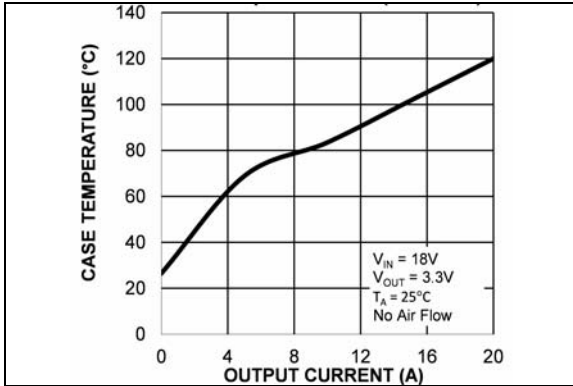

FIGURE 2-25: Case Temperature* vs. Output Current (MIC2125).

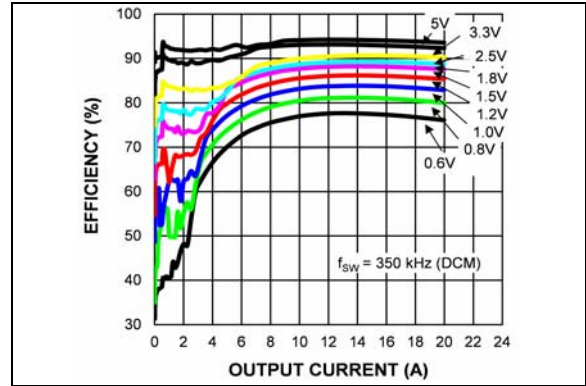

FIGURE 2-28: Efficiency ($V_{IN} = 18V$) vs. Output Current (MIC2125).

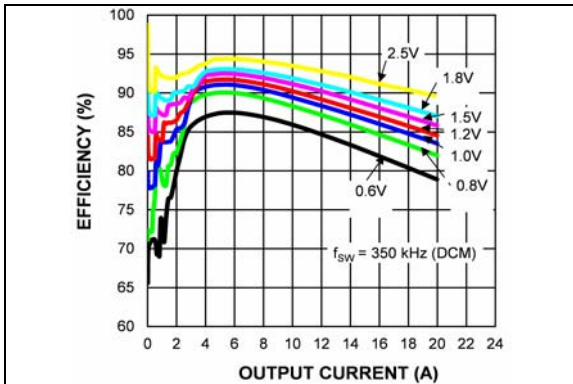

FIGURE 2-26: Efficiency ($V_{IN} = 5V$) vs. Output Current (MIC2125).

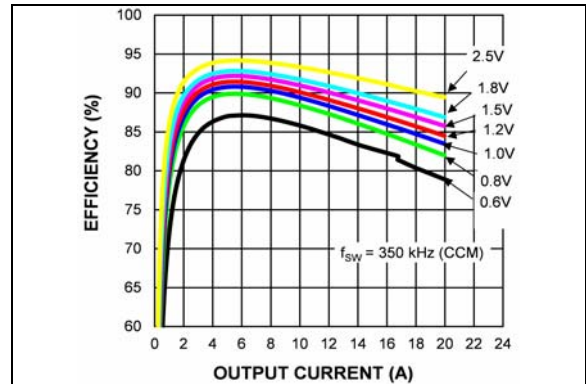

FIGURE 2-29: Efficiency ($V_{IN} = 5V$) vs. Output Current (MIC2126).

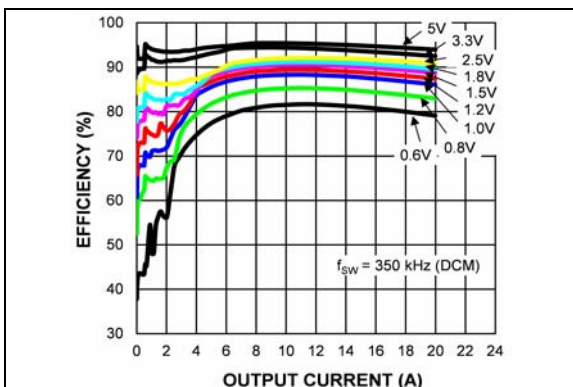

FIGURE 2-27: Efficiency ($V_{IN} = 12V$) vs. Output Current (MIC2125).

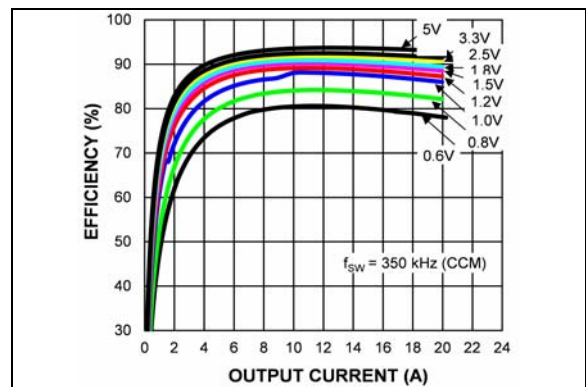

FIGURE 2-30: Efficiency ($V_{IN} = 12V$) vs. Output Current (MIC2126).

MIC2125/6

Note: Unless otherwise noted, $V_{IN} = 12V$, FREQ = 350 kHz.

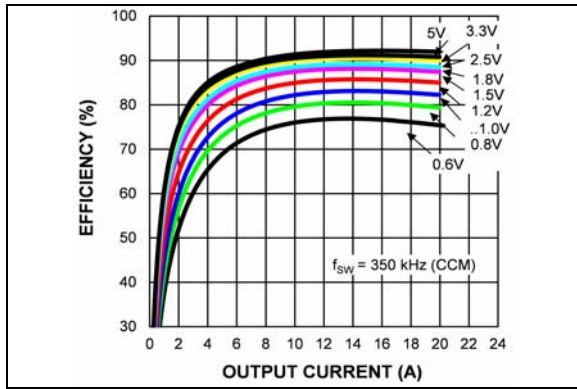

FIGURE 2-31: Efficiency ($V_{IN} = 18V$) vs. Output Current (MIC2126).

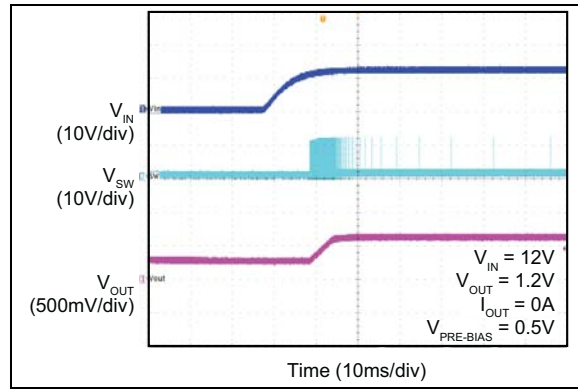

FIGURE 2-34: MIC2125 V_{IN} Start-Up with Prebiased Output.

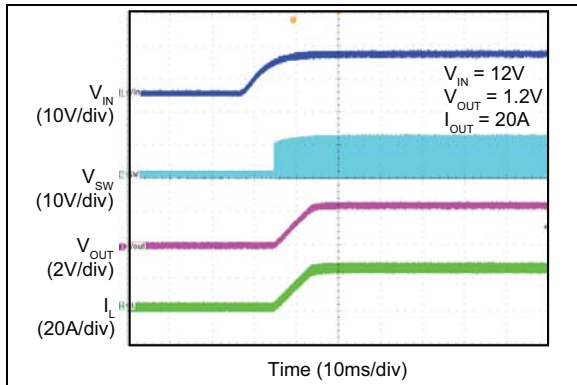

FIGURE 2-32: V_{IN} Soft Turn-On.

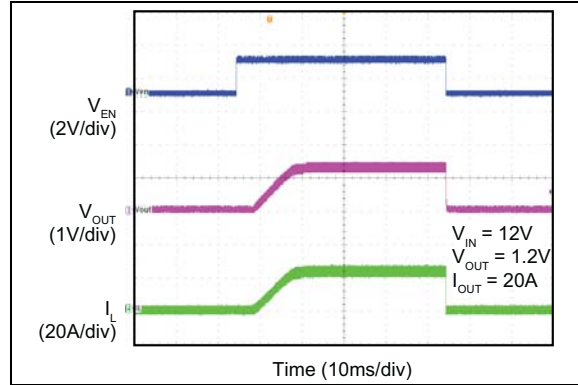

FIGURE 2-35: Enable Turn-On/Turn-Off.

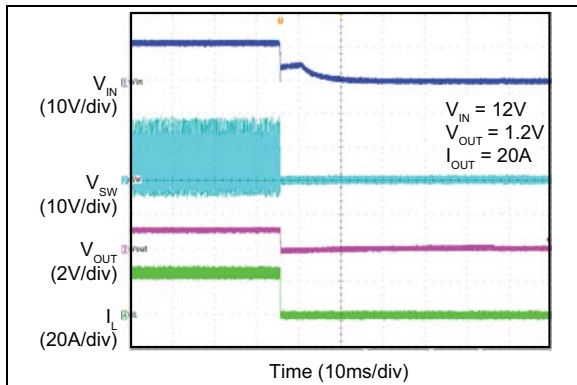

FIGURE 2-33: V_{IN} Soft Turn-Off.

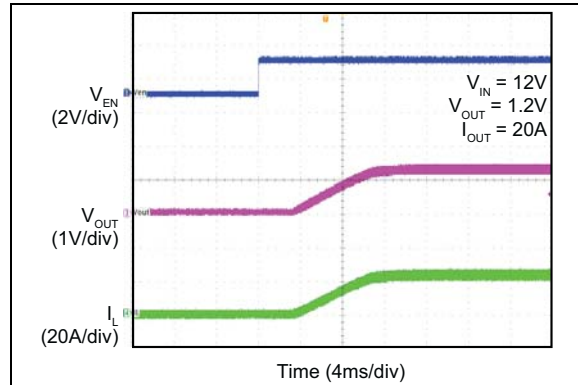

FIGURE 2-36: Enable Turn-On Delay and Rise Time.

Note: Unless otherwise noted, $V_{IN} = 12V$, $FREQ = 350\text{ kHz}$.

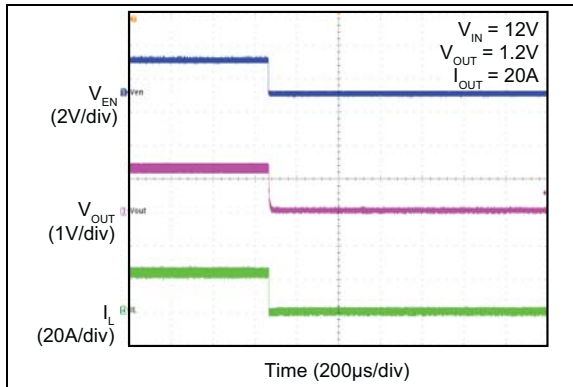

FIGURE 2-37: Enable Turn-Off Delay and Fall Time.

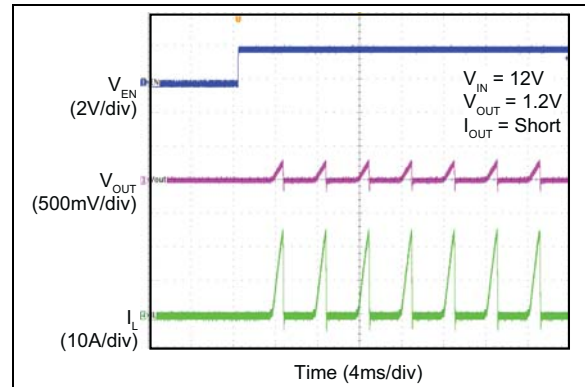

FIGURE 2-40: Enabled into Short.

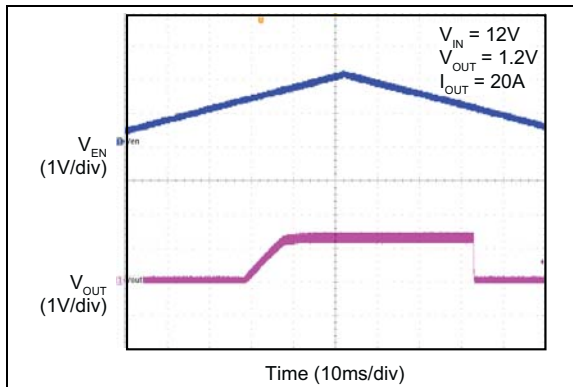

FIGURE 2-38: Enable Thresholds.

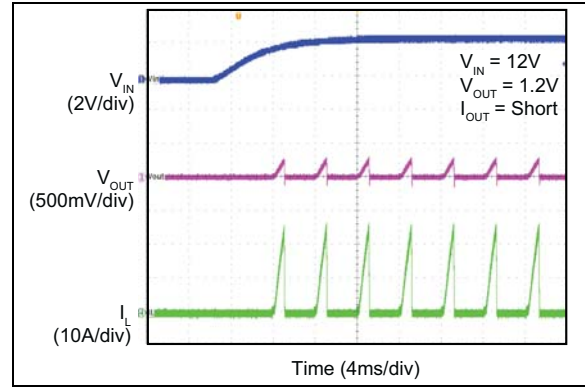

FIGURE 2-41: Power-Up into Short-Circuit.

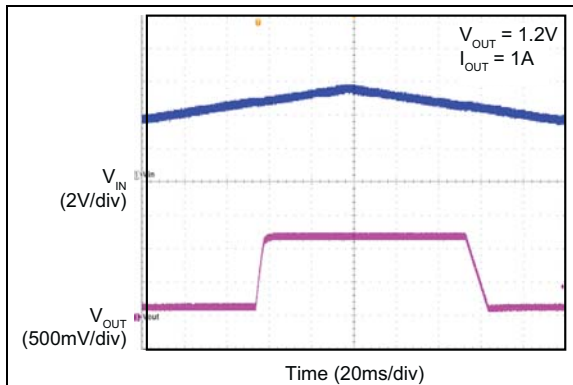

FIGURE 2-39: Enable Turn-On Delay and Rise Time.

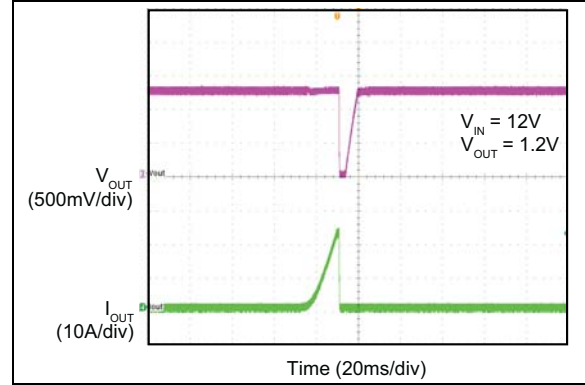

FIGURE 2-42: Output Peak Current-Limit Threshold.

MIC2125/6

Note: Unless otherwise noted, $V_{IN} = 12V$, $FREQ = 350\text{ kHz}$.

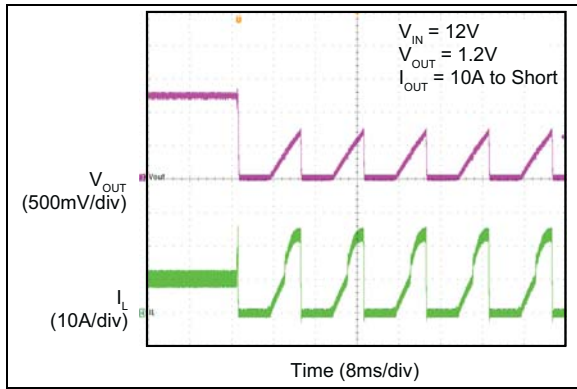

FIGURE 2-43: Short-Circuit.

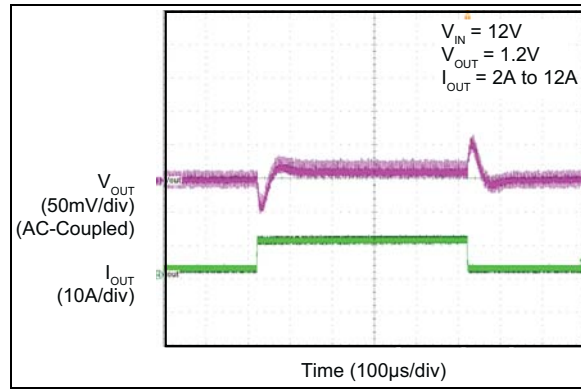

FIGURE 2-46: Transient Response.

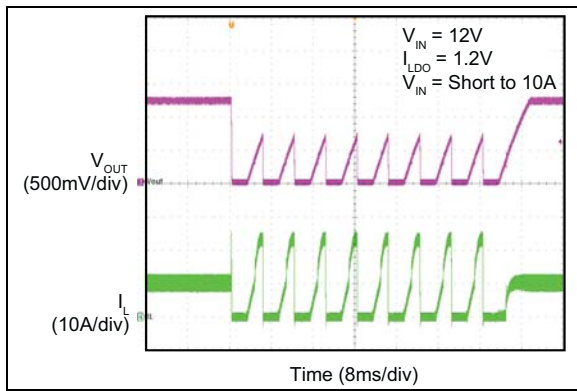

FIGURE 2-44: Output Recovery from Short-Circuit.

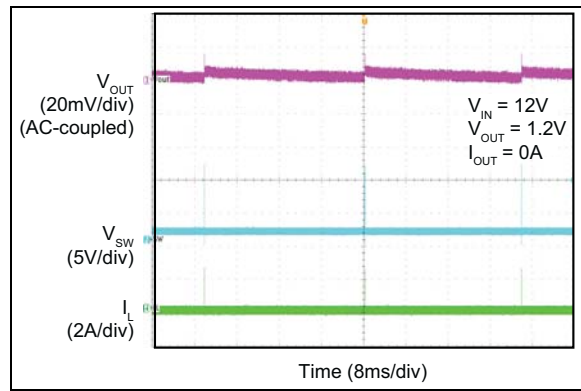

FIGURE 2-47: MIC2125 Switching Waveform, $I_{OUT} = 0A$.

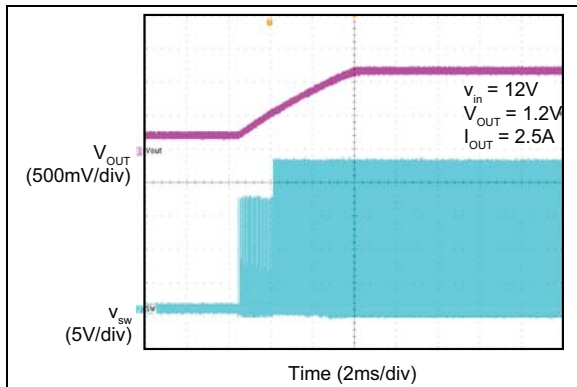

FIGURE 2-45: Output Recovery from Thermal Shutdown.

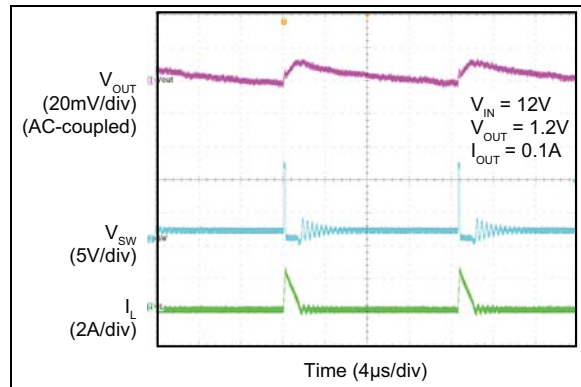

FIGURE 2-48: MIC2125 Switching Waveform, $I_{OUT} = 0.1A$.

Note: Unless otherwise noted, $V_{IN} = 12V$, $FREQ = 350\text{ kHz}$.

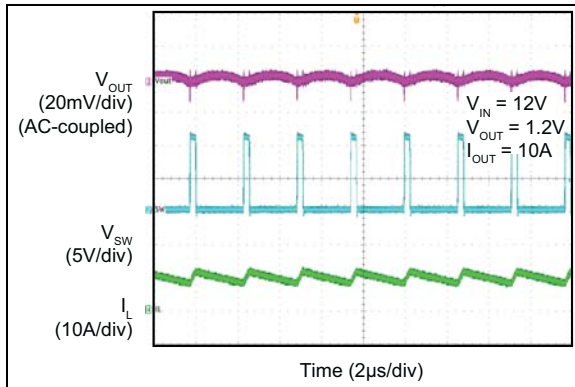

FIGURE 2-49: Switching Waveform, $I_{OUT} = 10A$.

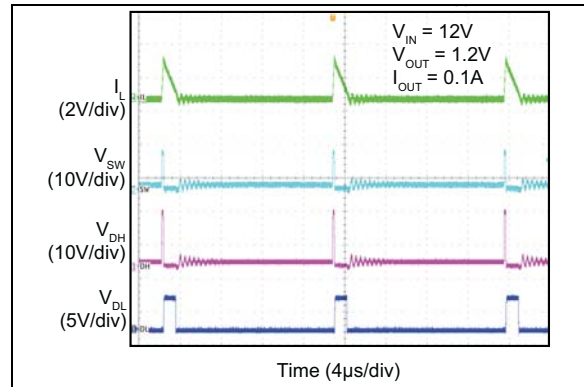

FIGURE 2-52: MIC2125 Switching Waveform, $I_{OUT} = 0.1A$.

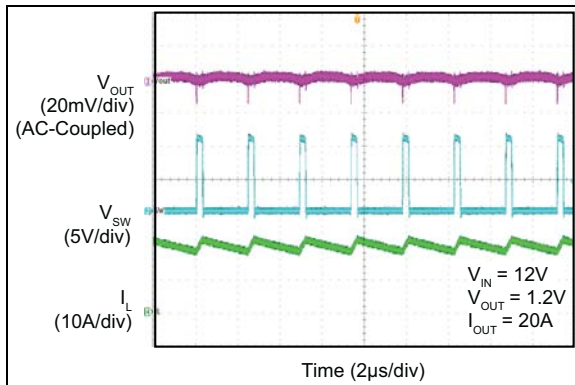

FIGURE 2-50: Switching Waveform, $I_{OUT} = 20A$.

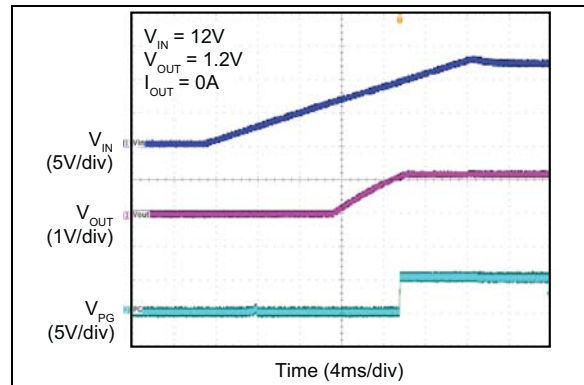

FIGURE 2-53: Power Good at V_{IN} Soft Turn-On.

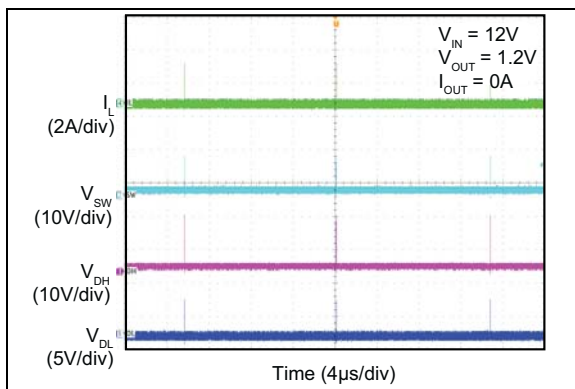

FIGURE 2-51: MIC2125 Switching Waveform, $I_{OUT} = 0A$.

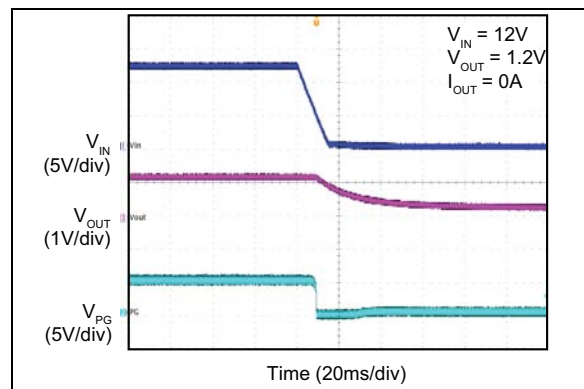

FIGURE 2-54: Power Good at V_{IN} Soft Turn-Off.

MIC2125/6

3.0 PIN DESCRIPTIONS

The descriptions of the pins are listed in [Table 3-1](#).

TABLE 3-1: PIN FUNCTION TABLE

Pin Number	Symbol	Description
1	V _{DD}	Internal Linear regulator output. Connect a 4.7 μ F ceramic capacitor from V _{DD} to A _{GND} for decoupling. In the applications where V _{IN} < +5.5V, V _{DD} should be tied to V _{IN} to by-pass the linear regulator.
2	P _{VDD}	5V supply input for the low-side N-channel MOSFET driver, which can be tied to V _{DD} externally. A 4.7 μ F ceramic capacitor from P _{VDD} to P _{GND} is recommended for decoupling.
3	I _{LIM}	Current limit setting input. Connect a resistor from SW to I _{LIM} to set the overcurrent threshold for the converter.
4	DL	Low-side gate driver output. The DL driving voltage swings from ground to V _{DD} .
5	P _{GND}	Power ground. P _{GND} is the return path for the low side gate driver. Connect P _{GND} pin to the source of low-side N-Channel external MOSFET.
6	FREQ	Switching frequency adjust input. Connect FREQ to the mid-point of an external resistor divider from V _{IN} to GND to program the switching frequency. Tie to V _{IN} to operate at 750 kHz frequency.
7	DH	High-side gate driver output. The DH driving voltage is floating on the switch node voltage (V _{SW}).
8	SW	Switch node and current-sense input. Connect the SW pin to the switch node of the buck converter. The SW pin also senses the current by monitoring the voltage across the low-side MOSFET during OFF time. In order to sense the current accurately, connect the low-side MOSFET drain to the SW pin using a Kelvin connection.
9	BST	Bootstrap Capacitor Input. Connect a ceramic capacitor with a minimum value of 0.1 μ F from BST to SW.
10	OVP	Output Overvoltage Protection Input. Connect to the mid-point of an external resistive divider from the V _{OUT} to GND to program overvoltage limit. Connect to A _{GND} if the output overvoltage protection is not required.
11	NC	No connect.
12	A _{GND}	Analog Ground. Connect A _{GND} to the exposed pad.
13	FB	Feedback input. Input to the transconductance amplifier of the control loop. The FB pin is regulated to 0.6V. A resistor divider connecting the feedback to the output is used to set the desired output voltage.
14	PG	Open-drain Power good output. Pull-up with an external pull-up resistor to V _{DD} or to an external power rail.
15	EN	Enable input. A logic signal to enable or disable the buck converter operation. Logic-high enables the device; logic-low shuts down the regulator. In disable mode, the V _{DD} supply current for the device is minimized to 0.1 μ A typically. Do not pull-up EN pin to V _{DD} /P _{VDD} .
16	V _{IN}	Supply voltage input. The V _{IN} operating voltage range is from 4.5V to 28V. A 1 μ F ceramic capacitor from V _{IN} to A _{GND} is required for decoupling.
17	EP	Exposed Pad. Connect the exposed pad to the A _{GND} copper plane to improve the thermal performance.

4.0 FUNCTIONAL DESCRIPTION

The MIC2125 and MIC2126 are adaptive on-time synchronous buck controllers built for high input voltage to low output voltage applications. They are designed to operate over a wide input voltage range from 4.5V to 28V and their output is adjustable with an external resistive divider. An adaptive ON-time control scheme is employed to obtain a constant switching frequency and to simplify the control compensation. Overcurrent protection is implemented when sensing low-side MOSFET's $R_{DS(ON)}$. The device features internal soft-start, enable, UVLO, and thermal shutdown.

4.1 Theory of Operation

The MIC2125/6 [Functional Block Diagram](#) appears on page two. The output voltage is sensed by the MIC2125/6 feedback pin (FB), and is compared to a 0.6V reference voltage (V_{REF}) at the low gain transconductance error amplifier (g_m). [Figure 4-1](#) shows the MIC2125/6 control loop timing during steady-state operation. When the feedback voltage decreases and the amplifier output is below 0.6V, the comparator triggers and generates an ON-time period. The ON-time period is predetermined by the fixed t_{ON} estimator circuitry value from [Equation 4-1](#):

EQUATION 4-1:

$$t_{ON(ESTIMATED)} = \frac{V_{OUT}}{V_{IN} \times f_{SW}}$$

Where:

V_{OUT}	Output Voltage
V_{IN}	Power Stage Input Voltage
f_{SW}	Switching Frequency

At the end of the ON-time, the internal high-side driver turns off the high-side MOSFET and the low-side driver turns on the low-side MOSFET. The OFF-time depends upon the feedback voltage. When the feedback voltage decreases and the output of the g_m amplifier is below 0.6V, the ON-time period is triggered and the OFF-time period ends. If the OFF-time period determined by the feedback voltage is less than the minimum OFF-time $t_{OFF(min)}$, which is about 220 ns, the MIC2125/6 control logic applies the $t_{OFF(min)}$ instead. $t_{OFF(min)}$ is required to maintain enough energy in the boost capacitor (C_{BST}) to drive the high-side MOSFET.

The maximum duty cycle is obtained from the 220 ns $t_{OFF(MIN)}$:

EQUATION 4-2:

$$D_{MAX} = \frac{t_S - t_{OFF(MIN)}}{t_S} = 1 - \frac{220ns}{t_S}$$

Where:

t_S	$1/f_{SW}$
-------	------------

It is not recommended to use MIC2125/6 with an OFF-time close to $t_{OFF(MIN)}$ during steady-state operation.

The adaptive ON-time control scheme results in a constant switching frequency in the MIC2125/6. The actual ON-time and resulting switching frequency varies with the different rising and falling times of the external MOSFETs. Also, the minimum t_{ON} results in a lower switching frequency in high V_{IN} to V_{OUT} applications.

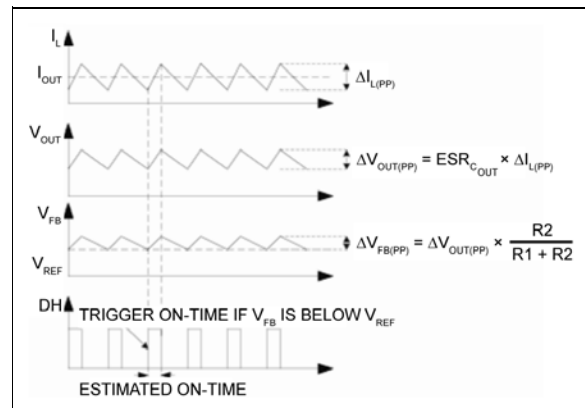

FIGURE 4-1: MIC2125/6 Control Loop Timing

[Figure 4-2](#) shows the operation of the MIC2125/6 during load transient. The output voltage drops due to a sudden increase in load, which results in the V_{FB} falling below V_{REF} . This causes the comparator to trigger an ON-time period. At the end of the ON-time, a minimum OFF-time $t_{OFF(min)}$ is generated to charge C_{BST} if the feedback voltage is still below V_{REF} . The next ON-time is triggered immediately after the $t_{OFF(min)}$ due to the low feedback voltage. This operation results in higher switching frequency during load transients. The switching frequency returns to the nominal set frequency once the output stabilizes at new load current level. The output recovery time is fast and the output voltage deviation is small in MIC2125/6 converter due to the varying duty cycle and switching frequency.

MIC2125/6

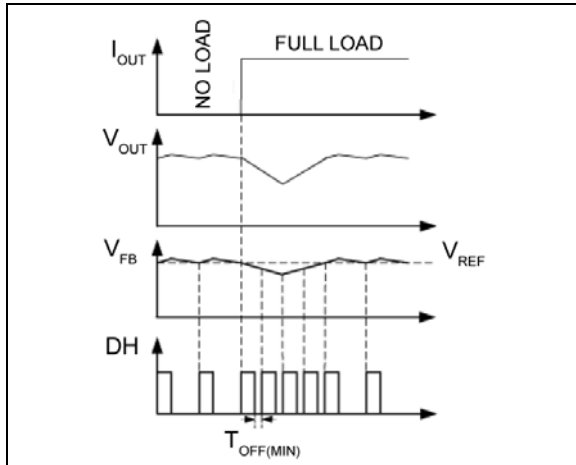

FIGURE 4-2: MIC2125/6 Load Transient Response

Unlike true current-mode control, the MIC2125/6 uses the output voltage ripple to trigger an ON-time period. In order to meet the stability requirements, the MIC2125/6 feedback voltage ripple should be in phase with the inductor current ripple and large enough to be sensed by the g_m amplifier. The recommended feedback voltage ripple is 20 mV ~ 100 mV over the full input voltage range. If a low-ESR output capacitor is selected, then the feedback voltage ripple may be too small to be sensed by the g_m amplifier. Also, the output voltage ripple and the feedback voltage ripple are not necessarily in phase with the inductor current ripple if the ESR of the output capacitor is very low. For these applications, ripple injection is required to ensure proper operation. Refer to the [Ripple Injection](#) section under [Application Information](#) for details about the ripple injection technique.

4.2 Discontinuous Conduction Mode (MIC2125 Only)

The MIC2125 operates in discontinuous conduction mode at light load. The MIC2125 has a zero crossing comparator (ZC detection) that monitors the inductor current by sensing the voltage drop across the low-side MOSFET during its ON-time. If the $V_{FB} > 0.6V$ and the inductor current goes slightly negative, the MIC2125 turns off both the high-side and low-side MOSFETs. During this period, the efficiency is optimized by shutting down all the non-essential circuits and the load current is supplied by the output capacitor. The control circuitry wakes up when the feedback voltage falls below V_{REF} and triggers a t_{ON} pulse. [Figure 4-3](#) shows the control loop timing in discontinuous conduction mode.

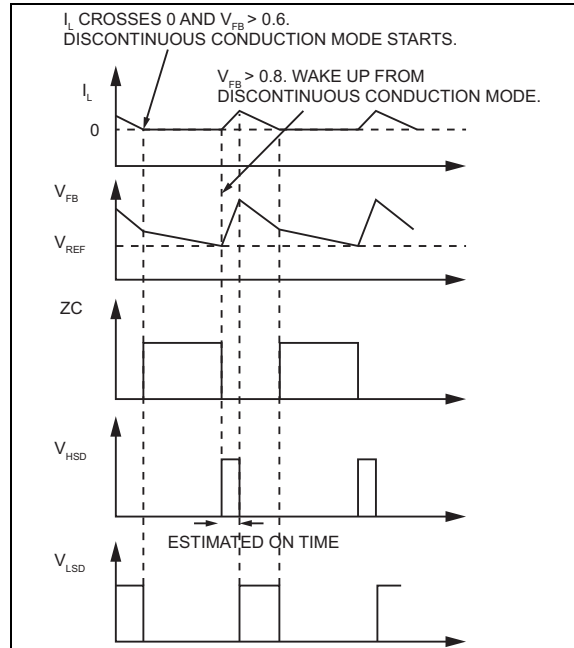

FIGURE 4-3: MIC2125 Control Loop Timing (Discontinuous Conduction Mode)

The typical no load supply current during discontinuous conduction mode is only about 340 μA , allowing the MIC2125 to achieve high efficiency at light load operation.

4.3 Soft-Start

Soft-start reduces the power supply inrush current at startup by controlling the output voltage rise time. The MIC2125/6 implements an internal digital soft-start by ramping up the reference voltage V_{REF} from 0 to 100% in about 7 ms. Once the soft-start is completed, the related circuitry is disabled to reduce the current consumption.

4.4 Current Limit

The MIC2125/6 uses the low-side MOSFET $R_{DS(ON)}$ to sense the inductor current.

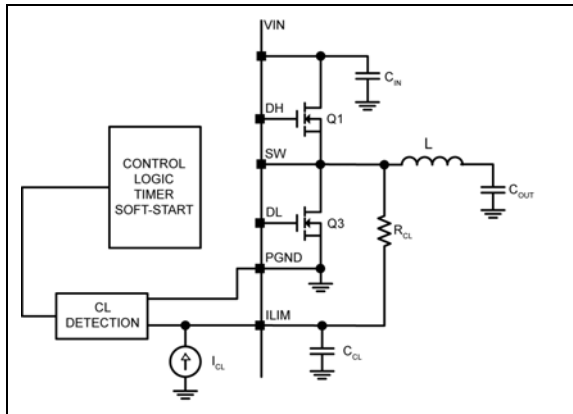

FIGURE 4-4: MIC2125/6 Current-Limiting Circuit

In each switching cycle of the MIC2125/6 converter, the inductor current is sensed by monitoring the voltage across the low-side MOSFET during the OFF period. An internal current source of 36 μA generates a voltage across the external resistor R_{CL} . The I_{LIM} pin voltage $V_{(ILIM)}$ is the sum of the voltage across the low side MOSFET and the voltage across the resistor (V_{CL}). The sensed voltage $V_{(ILIM)}$ is compared with the power ground (P_{GND}) after a blanking time of 150 ns.

If the absolute value of the voltage drop across the low side MOSFET is greater than V_{CL} , the current limit event is triggered. Eight consecutive current limit events triggers hiccup mode. The hiccup sequence, including the soft-start, reduces the stress on the switching FETs and protects the load and supply from severe short conditions.

The current limit can be programmed by using Equation 4-3.

EQUATION 4-3:

$$R_{CL} = \frac{(I_{CLIM} + \Delta_{PP} \times 0.5) \times R_{DS(ON)} - V_{OFFSET}}{I_{CL}}$$

Where:

I_{CLIM}	Desired Current Limit
Δ_{PP}	Inductor Current Peak-to-Peak
$R_{DS(ON)}$	On-Resistance of Low-Side Power MOSFET
V_{OFFSET}	Current-Limit Comparator Offset (Typical Value is -4 mV per Table 1-1)
I_{CL}	Current-Limit Source Current (Typical Value is 36 μA , per Table 1-1)

Because MOSFET $R_{DS(ON)}$ varies from 30% to 40% with temperature, it is recommended to add a 50% margin to I_{CL} in the previous equation to avoid false current limiting due to increased MOSFET junction temperature rise. It is also recommended to connect the SW pin directly to the drain of the low-side MOSFET to accurately sense the MOSFET's $R_{DS(ON)}$.

4.5 Negative Current Limit (MIC2126 Only)

The MIC2126 implements negative current limit by sensing the SW voltage when the low-side FET is off. If the SW node voltage exceeds 12 mV typical, the device turns off the low-side FET until the next ON-time event is triggered. The negative current limit value is given by Equation 4-4.

EQUATION 4-4:

$$I_{NLIM} = \frac{12mV}{R_{DS(ON)}}$$

Where:

I_{NLIM}	Negative Current Limit
$R_{DS(ON)}$	On-Resistance of Low-Side Power MOSFET

4.6 MOSFET Gate Drive

The MIC2125/6 high-side drive circuit is designed to switch an N-Channel MOSFET. Figure 4-1 shows a bootstrap circuit, consisting of a PMOS switch and C_{BST} . This circuit supplies energy to the high-side drive circuit. Capacitor C_{BST} is charged while the low-side MOSFET is on and the voltage on the SW pin is approximately 0V. When the high-side MOSFET driver is turned on, energy from C_{BST} is used to turn the MOSFET on. If the bias current of the high-side driver is less than 10 mA, a 0.1 μF capacitor is sufficient to hold the gate voltage within minimal droop, (i.e., $\Delta_{BST} = 10 \text{ mA} \times 3.33 \mu\text{s}/0.1 \mu\text{F} = 333 \text{ mV}$). A small resistor, R_G in series with C_{BST} , can be used to slow down the turn-on time of the high-side N-channel MOSFET.

4.7 Overvoltage Protection

The MIC2125/6 includes the OVP feature to protect the load from overshoots due to input transients and output short to a high voltage. When the overvoltage condition is triggered, the converter turns off immediately to allow the output voltage to discharge. The MIC2125/6 power should be recycled to enable it again.

MIC2125/6

5.0 APPLICATION INFORMATION

5.1 Setting the Switching Frequency

The MIC2125/6 are adjustable-frequency, synchronous buck controllers featuring a unique adaptive ON-time control architecture. The switching frequency can be adjusted between 200 kHz and 750 kHz by changing the resistor divider network consisting of R19 and R20.

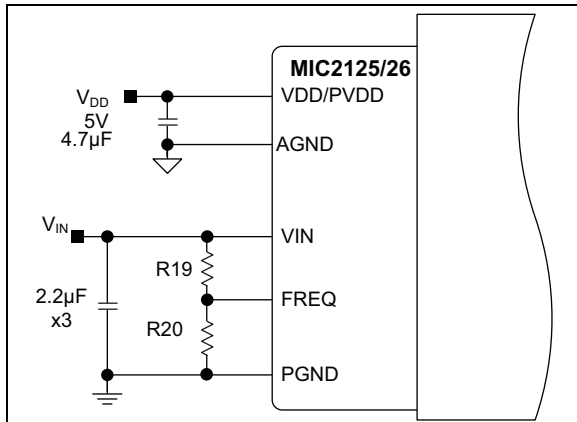

FIGURE 5-1: Switching Frequency Adjustment.

Equation 5-1 gives the estimated switching frequency.

EQUATION 5-1:

$$f_{SW(ADJ)} = f_O \times \frac{R20}{R19 + R20}$$

Where:

f_O Switching Frequency when R19 is 100 k Ω and R20 is open. f_O is typically 750 kHz.

For more precise setting, it is recommended to use Figure 5-2.

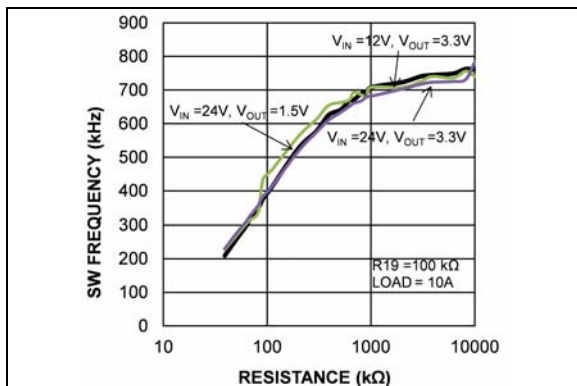

FIGURE 5-2: Switching Frequency vs. R20

5.2 MOSFET Selection

Voltage rating, on-resistance, and total gate charge are important parameters for MOSFET selection.

The voltage rating for the high-side and low-side MOSFETs are essentially equal to the power stage input voltage V_{IN} . A safety factor of 30% should be added to the $V_{IN(MAX)}$ while selecting the voltage rating of the MOSFETs to account for voltage spikes due to circuit parasitic elements.

The power dissipated in the MOSFETs is the sum of conduction losses ($P_{CONDUCTION}$) and switching losses (P_{AC}).

EQUATION 5-2:

$$P_{SW} = P_{CONDUCTION} + P_{AC}$$

EQUATION 5-3:

$$P_{CONDUCTION} = I_{SW(RMS)}^2 \times R_{DS(ON)}$$

Where:

$R_{DS(ON)}$ On-Resistance of the MOSFET
 $I_{SW(RMS)}$ RMS current of the MOSFET

The total high-side MOSFET switching loss is:

EQUATION 5-4:

$$P_{AC} = 0.5 \times V_{IN} \times I_{LOAD} \times (t_R + t_F) \times f_{SW}$$

Where:

t_R/t_F Switching Transition Times
 I_{LOAD} Load Current
 f_{SW} Switching Frequency

Turn-on and turn-off transition times can be approximated by:

EQUATION 5-5:

$$t_R = \frac{Q_{SW(HS)} \times (R_{HSD(PULL-UP)} + R_{HS(GATE)})}{V_{DD} - V_{TH}}$$

EQUATION 5-6:

$$t_F = \frac{Q_{SW(HS)} \times (R_{HSD(PULL-UP)} + R_{HS(GATE)})}{V_{TH}}$$

Where:

$R_{HSD(PULL-UP)}$	High-Side Gate Driver Pull-Up Resistance
$R_{HSD(PULL-DOWN)}$	High-Side Gate Driver Pull-Down Resistance
$R_{HS(GATE)}$	High-Side MOSFET Gate Resistance
$Q_{SW(HS)}$	Switching Gate Charge of the High-Side MOSFET
V_{TH}	Gate Threshold Voltage

The high-side MOSFET switching losses increase with the switching frequency and the input voltage. The low-side MOSFET switching losses are negligible and can be ignored for these calculations.

5.3 Inductor Selection

Inductance value, saturation, and RMS currents are required to select the output inductor. The input and output voltages and the inductance value determine the peak-to-peak inductor ripple current. Larger peak-to-peak ripple current increases the power dissipation in the inductor and MOSFETs. Larger output ripple current also requires more output capacitance to smooth out the larger ripple current. Smaller peak-to-peak ripple current requires a larger inductance value and therefore a larger and more expensive inductor.

A good compromise between size, loss, and cost is to set the inductor ripple current to be equal to 40% of the maximum output current.

The inductance value is calculated by [Equation 5-7](#).

EQUATION 5-7:

$$L = \frac{V_{OUT} \times (V_{IN(MAX)} - V_{OUT})}{V_{IN(MAX)} \times f_{SW} \times 0.4 \times I_{OUT(MAX)}}$$

Where:

f_{SW}	Switching Frequency
0.4	Ratio of AC Ripple Current to DC Output Current
$V_{IN(MAX)}$	Maximum Power Stage Input Voltage

The peak-to-peak inductor current ripple is:

EQUATION 5-8:

$$\Delta I_{L(PP)} = \frac{V_{OUT} \times (V_{IN(MAX)} - V_{OUT})}{V_{IN(MAX)} \times f_{SW} \times L}$$

The peak inductor current is equal to the average output current plus one half of the peak-to-peak inductor current ripple.

EQUATION 5-9:

$$I_{L(PK)} = I_{OUT(MAX)} + 0.5 \times \Delta I_{L(PP)}$$

The saturation current rating is given by:

EQUATION 5-10:

$$I_{L(SAT)} = \frac{(R_{CL} \times I_{CL}) - V_{OFFSET}}{R_{DS(ON)}}$$

Where:

R_{CL}	Current-Limit Resistor
I_{CL}	Current-Limit Source Current
V_{OFFSET}	Current-Limit Comparator Offset
$R_{DS(ON)}$	On-Resistance of Low-Side Power MOSFET

The RMS inductor current is used to calculate the I^2R losses in the inductor.

EQUATION 5-11:

$$I_{L(RMS)} = \sqrt{I_{OUT(MAX)}^2 + \frac{\Delta I_{L(PP)}^2}{12}}$$

Maximizing efficiency requires the proper selection of core material and minimizing the winding resistance. The high-frequency operation of the MIC2125/6 requires the use of ferrite materials. Lower cost iron powder cores may be used, but the increase in core loss reduces the efficiency of the power supply. This is especially noticeable at low output power. The winding resistance decreases efficiency at the higher output current levels. The winding resistance must be minimized, although this usually comes at the expense of a larger inductor. The power dissipated in the inductor is equal to the sum of the core and copper losses. At higher output loads, the core losses are usually insignificant and can be ignored. At lower output currents, the core losses can be significant. Core loss information is usually available from the magnetics vendor.

The amount of copper loss in the inductor is calculated by [Equation 5-12](#):

EQUATION 5-12:

$$P_{INDUCTOR(CU)} = I_{L(RMS)}^2 \times R_{WINDING}$$

MIC2125/6

5.4 Output Capacitor Selection

The type of the output capacitor is usually determined by its equivalent series resistance (ESR). Voltage and RMS current capability are two other important factors for selecting the output capacitor. Recommended capacitor types are ceramic, tantalum, low-ESR aluminum electrolytic, OS-CON, and POSCAP. The output capacitor's ESR is usually the main cause of the output ripple. The output capacitor ESR also affects the control loop from a stability point of view. The maximum value of ESR is calculated by [Equation 5-13](#).

EQUATION 5-13:

$$ESR_{C_{OUT}} \leq \frac{\Delta V_{OUT(PP)}}{\Delta I_{L(PP)}}$$

Where:

$\Delta V_{OUT(PP)}$ Peak-to-Peak Output Voltage Ripple
 $\Delta I_{L(PP)}$ Peak-to-Peak Inductor Current Ripple

The required output capacitance is calculated in [Equation 5-14](#).

EQUATION 5-14:

$$C_{OUT} = \frac{\Delta I_{L(PP)}}{\Delta V_{OUT(PP)} \times f_{SW} \times 8}$$

Where:

C_{OUT} Output Capacitance Value
 f_{SW} Switching Frequency

As described in the [Theory of Operation](#) subsection of the [Functional Description](#), the MIC2125/26 requires at least 20 mV peak-to-peak ripple at the FB pin to ensure that the g_m amplifier and the comparator behave properly. Also, the output voltage ripple should be in phase with the inductor current. Therefore, the output voltage ripple caused by the output capacitors value should be much smaller than the ripple caused by the output capacitor ESR. If low-ESR capacitors, such as ceramic capacitors, are selected as the output capacitors, a ripple injection method should be applied to provide the enough feedback voltage ripple. Refer to the [Ripple Injection](#) subsection for details.

The voltage rating of the capacitor should be twice the output voltage for a tantalum and 20% greater for aluminum electrolytic or OS-CON. The output capacitor RMS current is calculated in [Equation 5-15](#).

EQUATION 5-15:

$$I_{C_{OUT}(RMS)} = \frac{\Delta I_{L(PP)}}{\sqrt{12}}$$

The power dissipated in the output capacitor is:

EQUATION 5-16:

$$P_{DISS(COUT)} = I_{COUT(RMS)}^2 \times ESR_{COUT}$$

5.5 Input Capacitor Selection

The input capacitor reduces peak current drawn from the power supply and reduces noise and voltage ripple on the input. The input voltage ripple depends on the input capacitance and ESR. The input capacitance and ESR values are calculated by using [Equation 5-17](#) and [Equation 5-18](#).

EQUATION 5-17:

$$C_{IN} = \frac{I_{OUT} \times D \times (1 - D)}{\eta \times \Delta V_{IN(C)} \times f_{SW}}$$

Where:

I_{OUT} Load Current
 η Power Conversion Efficiency
 $\Delta V_{IN(C)}$ Input Ripple Due to Capacitance Value

EQUATION 5-18:

$$ESR_{CIN} = \frac{\Delta V_{IN(ESR)}}{I_{L(PK)}}$$

Where:

$\Delta V_{IN(ESR)}$ Input Ripple Due to Capacitor ESR Value
 $I_{L(PK)}$ Peak Inductor Current

The input capacitor should be qualified for ripple current rating and voltage rating. The RMS value of the input capacitor current is determined at the maximum output current. Assuming the peak-to-peak inductor current ripple is low:

EQUATION 5-19:

$$I_{CIN(RMS)} \approx I_{OUT(MAX)} \times \sqrt{D \times (1 - D)}$$

The power dissipated in the input capacitor is:

EQUATION 5-20:

$$P_{DISS(CIN)} = I_{CIN(RMS)}^2 \times ESR_{CIN}$$

5.6 Output Voltage Setting

The MIC2125/26 requires two resistors to set the output voltage, as shown in [Figure 5-3](#).

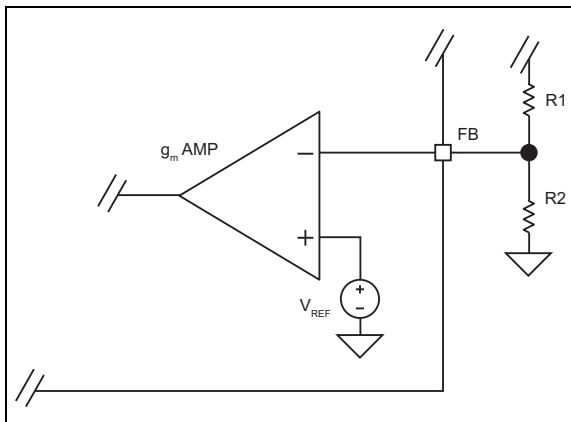

FIGURE 5-3: Voltage-Divider Configuration.

The output voltage is determined by [Equation 5-21](#):

EQUATION 5-21:

$$V_{OUT} = V_{FB} \times \left(1 + \frac{R1}{R2}\right)$$

Where:

V_{FB}	0.6V
----------	------

A typical value of R1 can be in the range of 3 kΩ and 15 kΩ. If R1 is too large, it may allow noise to be introduced into the voltage feedback loop. If R1 is too small in value, it will decrease the efficiency of the power supply, especially at light loads. Once R1 is selected, R2 can be calculated using [Equation 5-22](#).

EQUATION 5-22:

$$R2 = \frac{V_{FB} \times R1}{V_{OUT} - V_{FB}}$$

5.7 Output Overvoltage Limit Setting

The output overvoltage limit should be typically 20% higher than the nominal output voltage. Set the OVP limit by connecting a resistor divider from the output to ground as shown in [Figure 5-4](#).

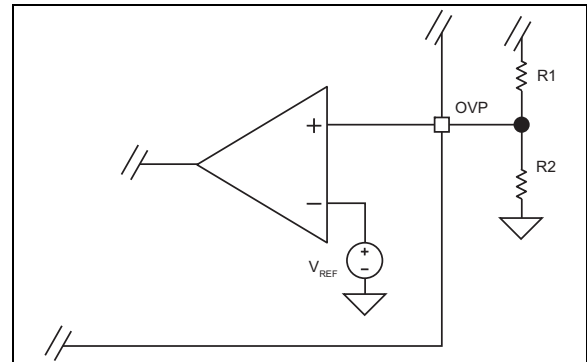

FIGURE 5-4: OVP Voltage-Divider Configuration.

Choose R2 in the range of 10 kΩ to 49.9 kΩ and calculate R1 using [Equation 5-23](#).

EQUATION 5-23:

$$R1 = R2 \left[\frac{V_{OVP}}{0.6} - 1 \right]$$

5.8 Ripple Injection

The V_{FB} ripple required for proper operation of the MIC2125/6 g_m amplifier and comparator is 20 mV to 100 mV. However, the output voltage ripple is generally designed as 1% to 2% of the output voltage. For low output voltages, such as a 1V, the output voltage ripple is only 10 mV to 20 mV, and the feedback voltage ripple is less than 20 mV. If the feedback voltage ripple is so small that the g_m amplifier and comparator cannot sense it, then the MIC2125/6 loses control and the output voltage is not regulated. In order to have sufficient V_{FB} ripple, a ripple injection method should be applied for low output voltage ripple applications.

The applications are divided into three situations according to the amount of the feedback voltage ripple:

- Enough ripple at the feedback voltage due to the large ESR of the output capacitors ([Figure 5-5](#)). The converter is stable without any ripple injection.

MIC2125/6

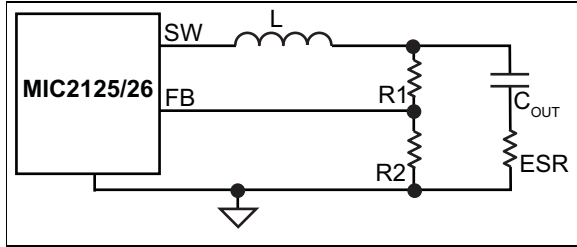

FIGURE 5-5: Enough Ripple at FB.

The feedback voltage ripple is:

EQUATION 5-24:

$$\Delta V_{FB(PP)} = \frac{R2}{R1 + R2} \times ESR_{C_{OUT}} \times \Delta I_{L(PP)}$$

Where:

$\Delta I_{L(PP)}$ Peak-to-Peak Value of the Inductor Current Ripple

- Inadequate ripple at the feedback voltage due to the small ESR of the output capacitors.

The output voltage ripple is fed into the FB pin through a feed-forward capacitor, C_{ff} in this situation, as shown in Figure 5-7. The typical C_{ff} value is between 1 nF and 100 nF.

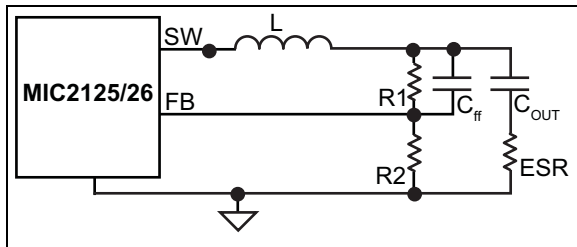

FIGURE 5-6: Inadequate Ripple at FB.

With the feed-forward capacitor, the feedback voltage ripple is very close to the output voltage ripple.

EQUATION 5-25:

$$\Delta V_{FB(PP)} \approx ESR \times \Delta I_{L(PP)}$$

- Virtually no ripple at the FB pin voltage due to the very low ESR of the output capacitors.

Therefore, additional ripple is injected into the FB pin from the switching node SW via a resistor R_{INJ} and a capacitor C_{INJ} , as shown in Figure 5-7.

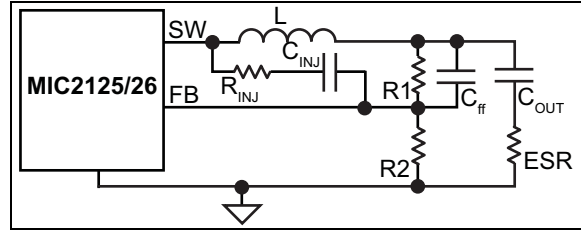

FIGURE 5-7: Invisible Ripple at FB.

The process of sizing the ripple injection resistor and capacitors is as follows.

- Select C_{INJ} as 100 nF, which can be considered as short for a wide range of the frequencies.
- Select C_{ff} to feed all output ripples into the feedback pin. Typical choice of C_{ff} is 0.47 nF to 47 nF, if R1 and R2 are in the kΩ range. The C_{ff} value can be calculated using Equation 5-26:

EQUATION 5-26:

$$C_{ff} \gg \frac{1}{R_p} \times \left(\frac{t_s \times V_{IN} \times D \times (1 - D)}{(V_{IN} \times D \times (1 - D)) - \Delta V_{FB(PP)}} \right)$$

Where:

V_{IN} Power Stage Input Voltage

D Duty Cycle

t_s $1/f_{SW}$

R_p $(R1//R2//R_{INJ})$

$\Delta V_{FB(PP)}$ Feedback Ripple

- Select R_{INJ} according to Equation 5-27.

EQUATION 5-27:

$$R_{INJ} = \frac{1}{C_{ff}} \times \left(\frac{V_{IN} \times D \times (1 - D)}{\Delta V_{FB(PP)} \times f_{SW}} \right)$$

6.0 PCB LAYOUT GUIDELINES

PCB layout is critical to achieve reliable, stable and efficient performance. The following guidelines should be followed to ensure proper operation of the MIC2125/26 converter.

6.1 IC

- The ceramic bypass capacitors which are connected to the V_{DD} and P_{VDD} pins must be located right at the IC. Use wide traces to connect to the V_{DD} , P_{VDD} and A_{GND} , P_{GND} pins respectively.
- The signal ground pin (A_{GND}) must be connected directly to the ground planes.
- Place the IC close to the point-of-load (POL).
- Signal and power grounds should be kept separate and connected at only one location.

6.2 Input Capacitor

- Place the input ceramic capacitors as close as possible to the MOSFETs.
- Place several vias to the ground plane close to the input capacitor ground terminal.

6.3 Inductor

- Keep the inductor connection to the switch node (SW) short.
- Do not route any digital lines underneath or close to the inductor.
- Keep the switch node (SW) away from the feedback (FB) pin.
- The SW pin should be connected directly to the drain of the low-side MOSFET to accurately sense the voltage across the low-side MOSFET.

6.4 Output Capacitor

- Use a copper plane to connect the output capacitor ground terminal to the input capacitor ground terminal.
- The feedback trace should be separate from the power trace and connected as close as possible to the output capacitor. Sensing a long high-current load trace can degrade the DC load regulation.

6.5 MOSFETs

- MOSFET gate drive traces must be short. The ground plane should be the connection between the MOSFET source and P_{GND} .
- Choose a low-side MOSFET with a high C_{GS}/C_{GD} ratio and a low internal gate resistance to minimize the effect of d_v/d_t inducted turn-on.
- Use a 4.5V V_{GS} rated MOSFET. Its higher gate threshold voltage is more immune to glitches than a 2.5V or 3.3V rated MOSFET.

For more information about the Evaluation board layout, please contact Microchip sales.

MIC2125/6

7.0 PACKAGING INFORMATION

16-Lead QFN 3 mm x 3 mm Package Outline and Recommended Land Pattern

Note: For the most current package drawings, please see the Microchip Packaging Specification located at <http://www.microchip.com/packaging>

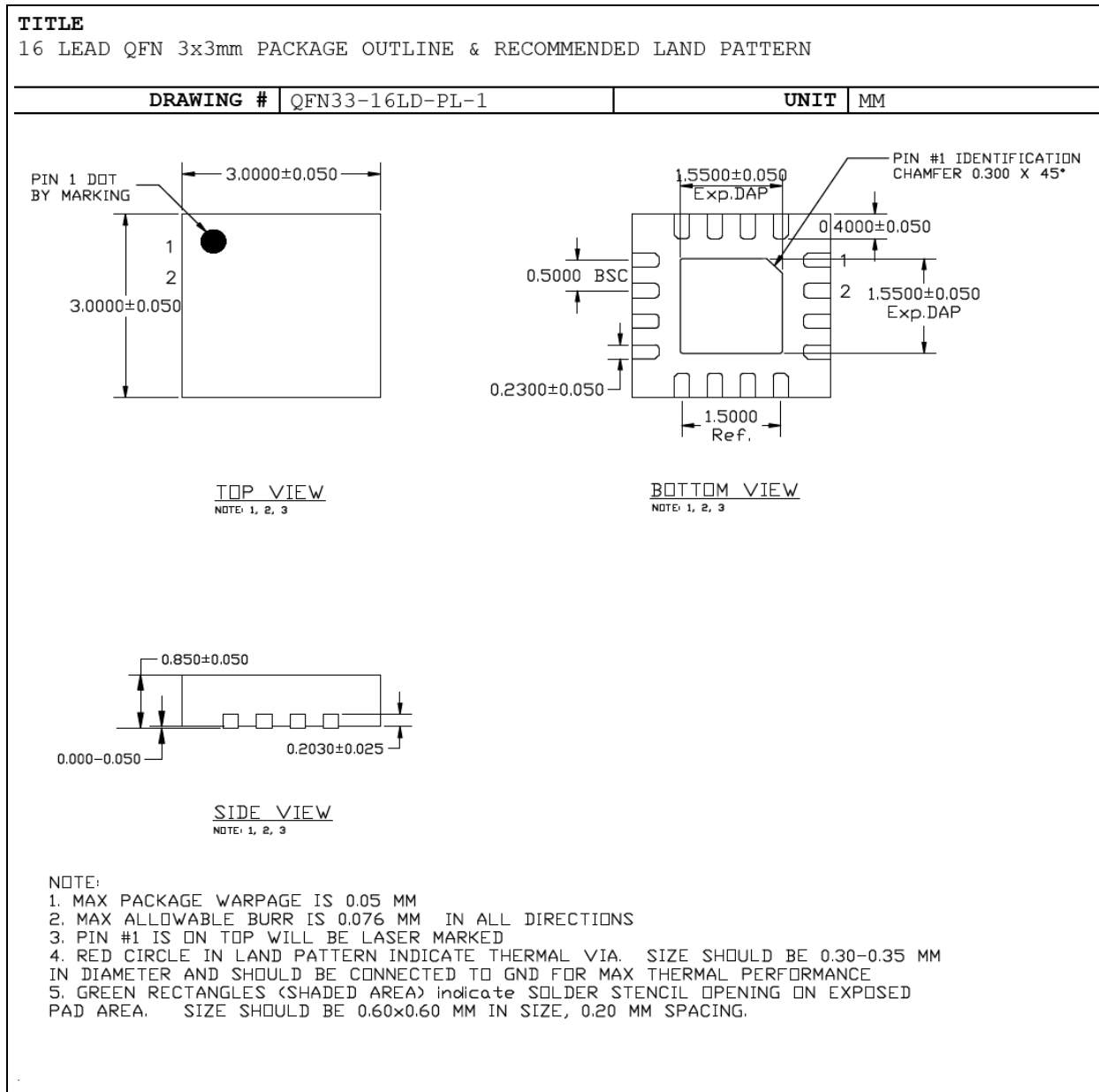

Note: For the most current package drawings, please see the Microchip Packaging Specification located at <http://www.microchip.com/packaging>

POD-Land Pattern drawing # QFN33-16LD-PL-1

RECOMMENDED LAND PATTERN

NOTE: 4, 5

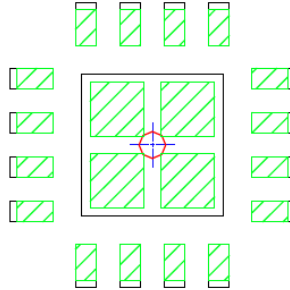

STACKED-UP

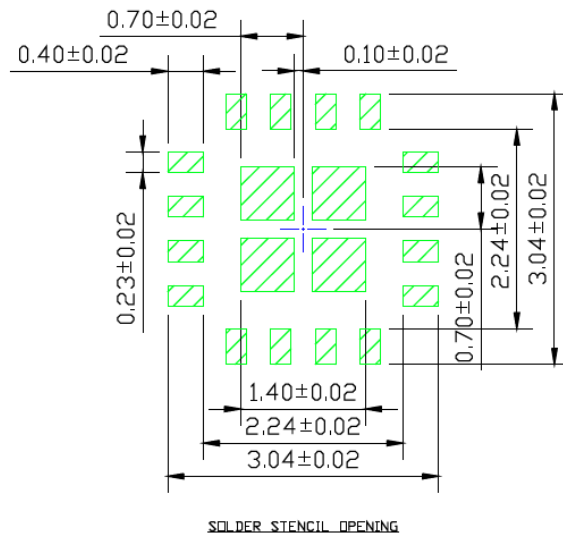
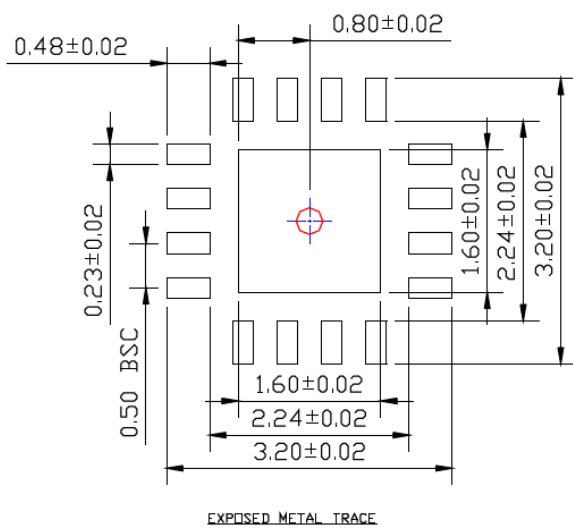

APPENDIX A: REVISION HISTORY

Revision A (November 2015)

- Original Conversion of this Document.

Revision B (December 2015)

- Corrected the erroneous listing of the MIC2126 example with a 64LD package. Replaced with correct 16LD package information.

MIC2125/6

NOTES:

PRODUCT IDENTIFICATION SYSTEM

To order or obtain information, e.g., on pricing or delivery, contact your local Microchip representative or sales office.

<u>PART NO.</u>		<u>X</u>	<u>XX</u>
		Device	Temperature Package
Device:	MIC2125:	28V, Synchronous Buck Controller featuring Adaptive On-Time Control with HyperLight Load	
	MIC2126:	28V, Synchronous Buck Controller featuring Adaptive On-Time Control with Hyper Speed Control	
Temperature:	Y =	-40°C to +125°C	
Package:	ML =	16-Pin 3 mm x 3 mm QFN	

Examples:	
a) MIC2125YML:	28V, Synchronous Buck Controller featuring Adaptive On-Time Control with HyperLight Load, -40°C to +125°C junction temperature range, 16LD QFN
b) MIC2126YML:	28V, Synchronous Buck Controller featuring Adaptive On-Time Control with Hyper Speed Control, -40°C to +125°C junction temperature range, 16LD QFN

MIC2125/6

NOTES:

Note the following details of the code protection feature on Microchip devices:

- Microchip products meet the specification contained in their particular Microchip Data Sheet.
- Microchip believes that its family of products is one of the most secure families of its kind on the market today, when used in the intended manner and under normal conditions.
- There are dishonest and possibly illegal methods used to breach the code protection feature. All of these methods, to our knowledge, require using the Microchip products in a manner outside the operating specifications contained in Microchip's Data Sheets. Most likely, the person doing so is engaged in theft of intellectual property.
- Microchip is willing to work with the customer who is concerned about the integrity of their code.
- Neither Microchip nor any other semiconductor manufacturer can guarantee the security of their code. Code protection does not mean that we are guaranteeing the product as “unbreakable.”

Code protection is constantly evolving. We at Microchip are committed to continuously improving the code protection features of our products. Attempts to break Microchip's code protection feature may be a violation of the Digital Millennium Copyright Act. If such acts allow unauthorized access to your software or other copyrighted work, you may have a right to sue for relief under that Act.

Information contained in this publication regarding device applications and the like is provided only for your convenience and may be superseded by updates. It is your responsibility to ensure that your application meets with your specifications. MICROCHIP MAKES NO REPRESENTATIONS OR WARRANTIES OF ANY KIND WHETHER EXPRESS OR IMPLIED, WRITTEN OR ORAL, STATUTORY OR OTHERWISE, RELATED TO THE INFORMATION, INCLUDING BUT NOT LIMITED TO ITS CONDITION, QUALITY, PERFORMANCE, MERCHANTABILITY OR FITNESS FOR PURPOSE. Microchip disclaims all liability arising from this information and its use. Use of Microchip devices in life support and/or safety applications is entirely at the buyer's risk, and the buyer agrees to defend, indemnify and hold harmless Microchip from any and all damages, claims, suits, or expenses resulting from such use. No licenses are conveyed, implicitly or otherwise, under any Microchip intellectual property rights unless otherwise stated.

Trademarks

The Microchip name and logo, the Microchip logo, dsPIC, FlashFlex, flexPWR, JukeBlox, KEELOQ, KEELOQ logo, Klear, LANCheck, MediaLB, MOST, MOST logo, MPLAB, OptoLyzer, PIC, PICSTART, PIC³² logo, RightTouch, SpyNIC, SST, SST Logo, SuperFlash and UNI/O are registered trademarks of Microchip Technology Incorporated in the U.S.A. and other countries.

The Embedded Control Solutions Company and mTouch are registered trademarks of Microchip Technology Incorporated in the U.S.A.

Analog-for-the-Digital Age, BodyCom, chipKIT, chipKIT logo, CodeGuard, dsPICDEM, dsPICDEM.net, ECAN, In-Circuit Serial Programming, ICSP, Inter-Chip Connectivity, KlearNet, KlearNet logo, MiWi, motorBench, MPASM, MPF, MPLAB Certified logo, MPLIB, MPLINK, MultiTRAK, NetDetach, Omniscient Code Generation, PICDEM, PICDEM.net, PICKit, PICTail, RightTouch logo, REAL ICE, SQI, Serial Quad I/O, Total Endurance, TSHARC, USBCheck, VariSense, ViewSpan, WiperLock, Wireless DNA, and ZENA are trademarks of Microchip Technology Incorporated in the U.S.A. and other countries.

SQTP is a service mark of Microchip Technology Incorporated in the U.S.A.

Silicon Storage Technology is a registered trademark of Microchip Technology Inc. in other countries.

GestIC is a registered trademark of Microchip Technology Germany II GmbH & Co. KG, a subsidiary of Microchip Technology Inc., in other countries.

All other trademarks mentioned herein are property of their respective companies.

© 2015, Microchip Technology Incorporated, Printed in the U.S.A., All Rights Reserved.

ISBN: 978-1-5224-0039-4

QUALITY MANAGEMENT SYSTEM
CERTIFIED BY DNV
== ISO/TS 16949 ==

Microchip received ISO/TS-16949:2009 certification for its worldwide headquarters, design and wafer fabrication facilities in Chandler and Tempe, Arizona; Gresham, Oregon and design centers in California and India. The Company's quality system processes and procedures are for its PIC[®] MCUs and dsPIC[®] DSCs, KEELOQ[®] code hopping devices, Serial EEPROMs, microperipherals, nonvolatile memory and analog products. In addition, Microchip's quality system for the design and manufacture of development systems is ISO 9001:2000 certified.



MICROCHIP

Worldwide Sales and Service

AMERICAS

Corporate Office

2355 West Chandler Blvd.
Chandler, AZ 85224-6199

Tel: 480-792-7200

Fax: 480-792-7277

Technical Support:

[http://www.microchip.com/
support](http://www.microchip.com/support)

Web Address:

www.microchip.com

Atlanta

Duluth, GA

Tel: 678-957-9614

Fax: 678-957-1455

Austin, TX

Tel: 512-257-3370

Boston

Westborough, MA

Tel: 774-760-0087

Fax: 774-760-0088

Chicago

Itasca, IL

Tel: 630-285-0071

Fax: 630-285-0075

Cleveland

Independence, OH

Tel: 216-447-0464

Fax: 216-447-0643

Dallas

Addison, TX

Tel: 972-818-7423

Fax: 972-818-2924

Detroit

Novi, MI

Tel: 248-848-4000

Houston, TX

Tel: 281-894-5983

Indianapolis

Noblesville, IN

Tel: 317-773-8323

Fax: 317-773-5453

Los Angeles

Mission Viejo, CA

Tel: 949-462-9523

Fax: 949-462-9608

New York, NY

Tel: 631-435-6000

San Jose, CA

Tel: 408-735-9110

Canada - Toronto

Tel: 905-673-0699

Fax: 905-673-6509

ASIA/PACIFIC

Asia Pacific Office

Suites 3707-14, 37th Floor
Tower 6, The Gateway
Harbour City, Kowloon

Hong Kong

Tel: 852-2943-5100

Fax: 852-2401-3431

Australia - Sydney

Tel: 61-2-9868-6733

Fax: 61-2-9868-6755

China - Beijing

Tel: 86-10-8569-7000

Fax: 86-10-8528-2104

China - Chengdu

Tel: 86-28-8665-5511

Fax: 86-28-8665-7889

China - Chongqing

Tel: 86-23-8980-9588

Fax: 86-23-8980-9500

China - Dongguan

Tel: 86-769-8702-9880

China - Hangzhou

Tel: 86-571-8792-8115

Fax: 86-571-8792-8116

China - Hong Kong SAR

Tel: 852-2943-5100

Fax: 852-2401-3431

China - Nanjing

Tel: 86-25-8473-2460

Fax: 86-25-8473-2470

China - Qingdao

Tel: 86-532-8502-7355

Fax: 86-532-8502-7205

China - Shanghai

Tel: 86-21-5407-5533

Fax: 86-21-5407-5066

China - Shenyang

Tel: 86-24-2334-2829

Fax: 86-24-2334-2393

China - Shenzhen

Tel: 86-755-8864-2200

Fax: 86-755-8203-1760

China - Wuhan

Tel: 86-27-5980-5300

Fax: 86-27-5980-5118

China - Xian

Tel: 86-29-8833-7252

Fax: 86-29-8833-7256

ASIA/PACIFIC

China - Xiamen

Tel: 86-592-2388138

Fax: 86-592-2388130

China - Zhuhai

Tel: 86-756-3210040

Fax: 86-756-3210049

India - Bangalore

Tel: 91-80-3090-4444

Fax: 91-80-3090-4123

India - New Delhi

Tel: 91-11-4160-8631

Fax: 91-11-4160-8632

India - Pune

Tel: 91-20-3019-1500

Japan - Osaka

Tel: 81-6-6152-7160

Fax: 81-6-6152-9310

Japan - Tokyo

Tel: 81-3-6880-3770

Fax: 81-3-6880-3771

Korea - Daegu

Tel: 82-53-744-4301

Fax: 82-53-744-4302

Korea - Seoul

Tel: 82-2-554-7200

Fax: 82-2-558-5932 or

82-2-558-5934

Malaysia - Kuala Lumpur

Tel: 60-3-6201-9857

Fax: 60-3-6201-9859

Malaysia - Penang

Tel: 60-4-227-8870

Fax: 60-4-227-4068

Philippines - Manila

Tel: 63-2-634-9065

Fax: 63-2-634-9069

Singapore

Tel: 65-6334-8870

Fax: 65-6334-8850

Taiwan - Hsin Chu

Tel: 886-3-5778-366

Fax: 886-3-5770-955

Taiwan - Kaohsiung

Tel: 886-7-213-7828

Taiwan - Taipei

Tel: 886-2-2508-8600

Fax: 886-2-2508-0102

Thailand - Bangkok

Tel: 66-2-694-1351

Fax: 66-2-694-1350

EUROPE

Austria - Wels

Tel: 43-7242-2244-39

Fax: 43-7242-2244-393

Denmark - Copenhagen

Tel: 45-4450-2828

Fax: 45-4485-2829

France - Paris

Tel: 33-1-69-53-63-20

Fax: 33-1-69-30-90-79

Germany - Dusseldorf

Tel: 49-2129-3766400

Germany - Karlsruhe

Tel: 49-721-625370

Germany - Munich

Tel: 49-89-627-144-0

Fax: 49-89-627-144-44

Italy - Milan

Tel: 39-0331-742611

Fax: 39-0331-466781

Italy - Venice

Tel: 39-049-7625286

Netherlands - Drunen

Tel: 31-416-690399

Fax: 31-416-690340

Poland - Warsaw

Tel: 48-22-3325737

Spain - Madrid

Tel: 34-91-708-08-90

Fax: 34-91-708-08-91

Sweden - Stockholm

Tel: 46-8-5090-4654

UK - Wokingham

Tel: 44-118-921-5800

Fax: 44-118-921-5820

07/14/15