



## MIC2605/6

**0.5A, 1.2MHz / 2MHz Wide Input Range  
Boost Regulator with Integrated Switch  
and Schottky Diode**

### General Description

The MIC2605/6 is a 1.2MHz/2MHz, PWM DC/DC boost switching regulator available in a 2mm x 2mm MLF<sup>®</sup> package. High power density is achieved with the MIC2605/6's internal 40V/0.5A switch and schottky diode, allowing it to power large loads in a tiny footprint.

The MIC2605/6 implements constant frequency 1.2MHz/2MHz PWM current mode control. The MIC2605/6 offers internal compensation that offers excellent transient response and output regulation performance. The high frequency operation saves board space by allowing small, low-profile external components. The fixed frequency PWM scheme also reduces spurious switching noise and ripple to the input power source.

The MIC2605/6 is available in an 8-pin 2mm x 2mm MLF<sup>®</sup> leadless package. This package has an output over-voltage protection feature.

The MIC2605/6 has an operating junction temperature range of -40°C to +125°C.

Data sheets and support documentation can be found on Micrel's web site at [www.micrel.com](http://www.micrel.com).

### Features

- Wide input voltage range: 4.5V to 20V
- Output voltage adjustable to 40V
- 0.5A switch current and schottky diode
- MIC2605 operates at 1.2MHz
- MIC2606 operates at 2MHz
- Programmable soft start
- Stable with small size ceramic capacitors
- High efficiency
- Low input and output ripple
- <10µA shutdown current
- UVLO
- Output over-voltage and over-temperature protection
- 8-pin 2mm x 2mm MLF<sup>®</sup> package
- -40°C to +125°C junction temperature range

### Applications

- TV-tuners
- Broadband communications
- TFT-LCD bias supplies
- Bias supply
- Positive output regulators
- SEPIC converters
- DSL applications
- Local boost regulators

### Typical Application

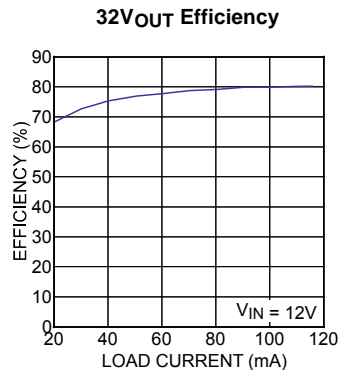
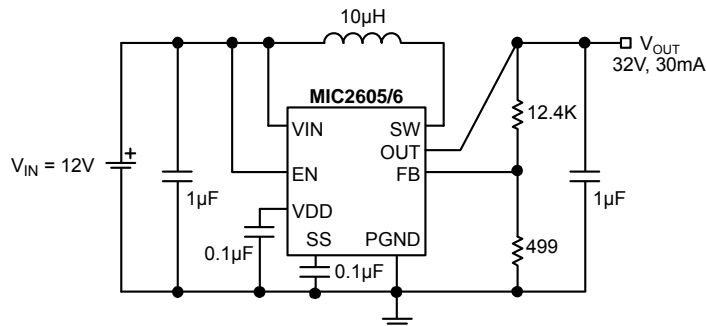

MLF and MicroLeadFrame are registered trademarks of Amkor Technology, Inc.

Micrel Inc. • 2180 Fortune Drive • San Jose, CA 95131 • USA • tel +1 (408) 944-0800 • fax +1 (408) 474-1000 • <http://www.micrel.com>

## Ordering Information

Part Number	Marking Code <sup>(1)</sup>	Frequency	Output Over Voltage Protection	Temperature Range	Package <sup>(2)</sup>	Lead Finish
MIC2605YML	WZ5	1.2MHz	40V	-40° to +125°C	8-Pin 2mm x 2mm MLF <sup>®</sup>	Pb-Free
MIC2606YML	WZ6	2MHz	40V	-40° to +125°C	8-Pin 2mm x 2mm MLF <sup>®</sup>	Pb-Free

### Notes

- Overbar (—) symbol may not be to scale.
- MLF<sup>®</sup> is a GREEN RoHS compliant package. Lead finish is NiPdAu. Mold compound is Halogen Free.

## Pin Configuration

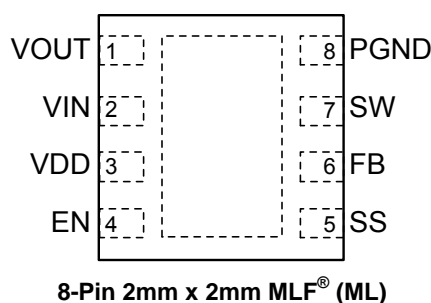

## Pin Description

Pin Number	Pin Name	Pin Function
1	VOUT	Output Pin: Connect to the output capacitor.
2	VIN	Supply (Input): 4.5V to 20V input voltage.
3	VDD	Internal regulated supply. VDD should be connected to VIN when $V_{IN} \leq 7V$ .
4	EN	Enable (Input): Logic high enables regulator. Logic low shuts down regulator.
5	SS	Soft start
6	FB	Feedback (Input): 1.25V output voltage sense node. $V_{OUT} = 1.25V (1 + R1/R2)$ .
7	SW	Switch Node (Input): Internal power BIPOLAR collector.
8	PGND	Power ground
EP	EPAD	Exposed backside pad for thermal cooling.

**Absolute Maximum Ratings<sup>(1)</sup>**

Supply Voltage ( $V_{IN}$ ).....	22V
Switch Voltage ( $V_{SW}$ ).....	-0.3V to 40V
Enable Voltage ( $V_{EN}$ ).....	-0.3V to $V_{IN}$
FB Voltage ( $V_{FB}$ ).....	$V_{DD}$
Ambient Storage Temperature ( $T_s$ ).....	-65°C to +150°C
Lead Temperature (soldering 10sec).....	260°C
ESD Rating <sup>(3)</sup> (MIC2605).....	2kV
ESD Rating <sup>(3)</sup> (MIC2606).....	1.5kV

**Operating Ratings<sup>(2)</sup>**

Supply Voltage ( $V_{IN}$ ).....	4.5V to 20V
Junction Temperature ( $T_J$ ).....	-40°C to +125°C
Junction Thermal Resistance	
2mm x 2mm MLF-8 ( $\theta_{JA}$ ).....	90°C/W
2mm x 2mm MLF-8 ( $\theta_{JC}$ ).....	45°C/W

**Electrical Characteristics<sup>(4)</sup>**

$T_A = 25^\circ\text{C}$ ,  $V_{IN} = V_{EN} = 12\text{V}$ ; unless otherwise noted. **Bold** values indicate  $-40^\circ\text{C} \leq T_J \leq +125^\circ\text{C}$ .

Symbol	Parameter	Condition	Min	Typ	Max	Units
$V_{IN}$	Input Voltage Range		4.5		20	V
$V_{DD}$	Internal Regulated Voltage	<b>Note 5</b>		5.8		V
$V_{ULVO}$	Under-voltage Lockout	For $V_{DD}$	1.8	2.1	2.4	V
$I_Q$	Quiescent Current	$V_{FB} = 2\text{V}$ (not switching)		4.2	6	mA
$I_{SD}$	Shutdown Current	$V_{EN} = 0\text{V}$ , <b>Note 6</b>		0.1	10	$\mu\text{A}$
$V_{FB}$	Feedback Voltage	( $\pm 2\%$ )	1.225	1.25	1.275	V
		( $\pm 3\%$ ) (over temperature)	<b>1.212</b>		<b>1.288</b>	V
$I_{FB}$	Feedback Input Current	$V_{FB} = 1.25\text{V}$		-550		nA
	Line Regulation	$8\text{V} \leq V_{IN} \leq 14\text{V}$ , $V_{OUT} = 18\text{V}$		0.04	1	%
	Load Regulation	$5\text{mA} \leq I_{OUT} \leq 40\text{mA}$ , $V_{OUT} = 18\text{V}$ , <b>Note 7</b>			1.5	%
$D_{MAX}$	Maximum Duty Cycle	MIC2605	85			%
		MIC2606	80			%
$I_{SW}$	Switch Current Limit	<b>Note 7</b>	0.5	0.8		A
$V_{SW}$	Switch Saturation Voltage	$I_{SW} = 0.5\text{A}$		600		mV
$I_{SW}$	Switch Leakage Current	$V_{EN} = 0\text{V}$ , $V_{SW} = 18\text{V}$		0.01	5	$\mu\text{A}$
$V_{EN}$	Enable Threshold	Turn ON	1.5			V
		Turn OFF			0.3	V
$I_{EN}$	Enable Pin Current	$V_{EN} = 12\text{V}$		20	40	$\mu\text{A}$
$f_{SW}$	Oscillator Frequency (MIC2605)		<b>1.02</b>	1.2	<b>1.38</b>	MHz
	Oscillator Frequency (MIC2606)		<b>1.7</b>	2	<b>2.3</b>	MHz
$V_D$	Schottky Forward Drop	$I_D = 1\text{mA}$		450		mV
		$I_D = 150\text{mA}$		850		mV
$I_{RD}$	Schottky Leakage Current	$V_R = 30\text{V}$		0.1	4	$\mu\text{A}$
$V_{OVP}$	Output Over-voltage Protection	15% Over programmed $V_{OUT}$	10	15	20	%
$T_J$	Over-temperature Threshold Shutdown			150		$^\circ\text{C}$
		Hysteresis		10		$^\circ\text{C}$

**Notes:**

1. Absolute maximum ratings indicate limits beyond which damage to the component may occur. Electrical specifications do not apply when operating the device outside of its operating ratings. The maximum allowable power dissipation is a function of the maximum junction temperature,  $T_{J(\text{MAX})}$ , the junction-to-ambient thermal resistance,  $\theta_{JA}$ , and the ambient temperature,  $T_A$ . The maximum allowable power dissipation will result in excessive die temperature, and the regulator will go into thermal shutdown.
2. The device is not guaranteed to function outside its operating rating.
3. IC devices are inherently ESD sensitive. Handling precautions required. Human body model rating: 1.5k in series with 100pF.
4. Specification for packaged product only.
5. Connect  $V_{DD}$  pin to  $V_{IN}$  pin when  $V_{IN} \leq 7\text{V}$ .
6.  $I_{SD} = I_{VIN}$ .

7. Guaranteed by design.

# Typical Characteristics

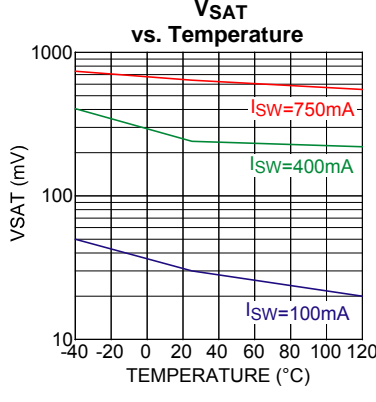
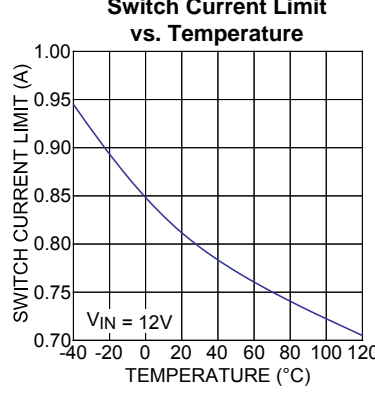
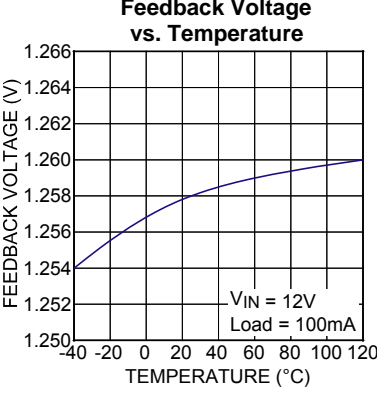
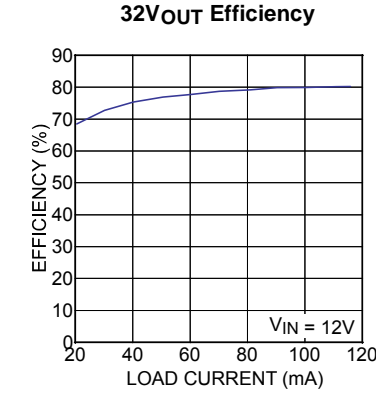
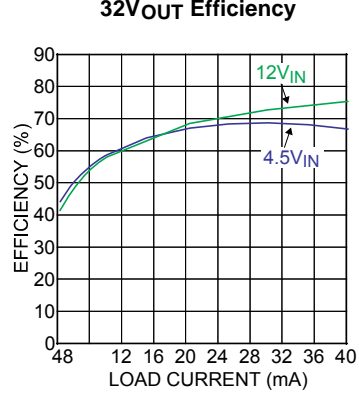
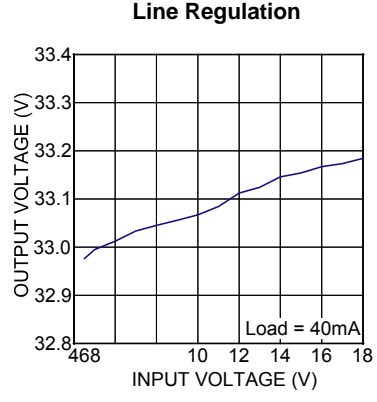
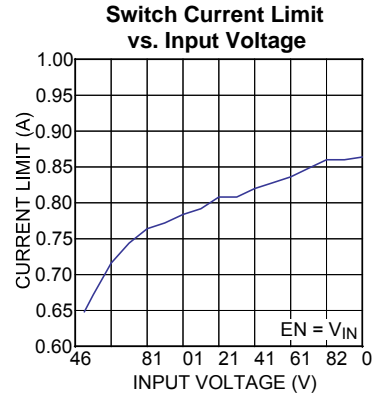
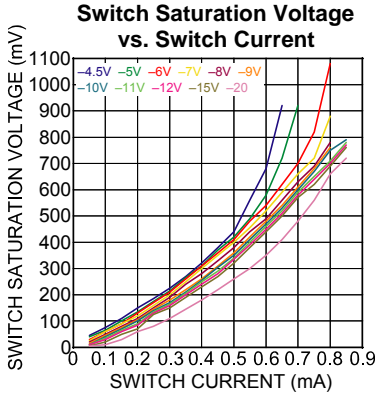
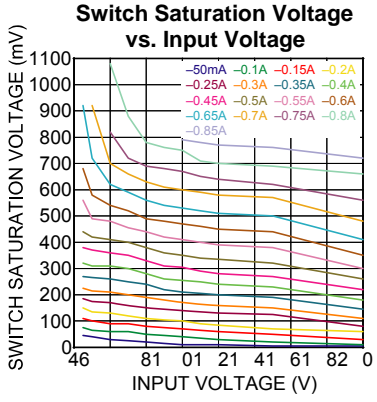
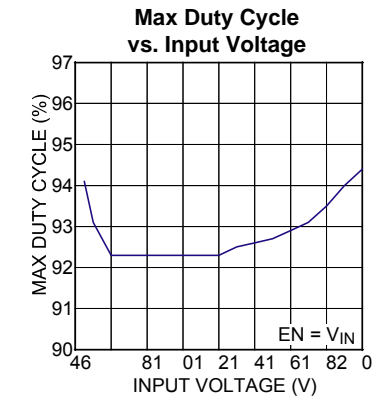
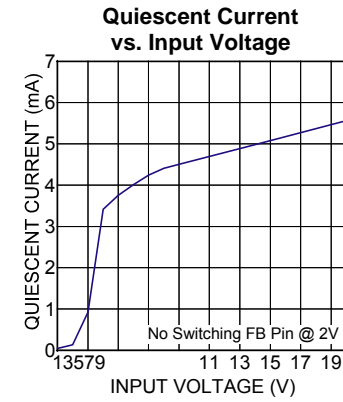
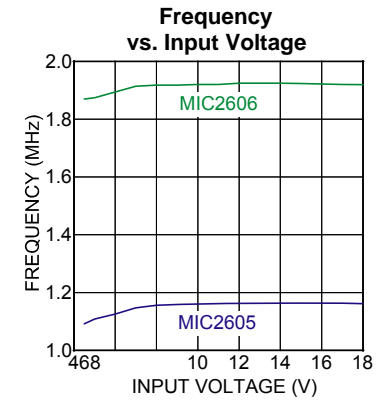

Typical Characteristics (continued)

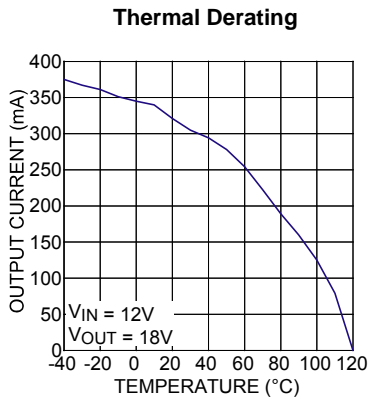
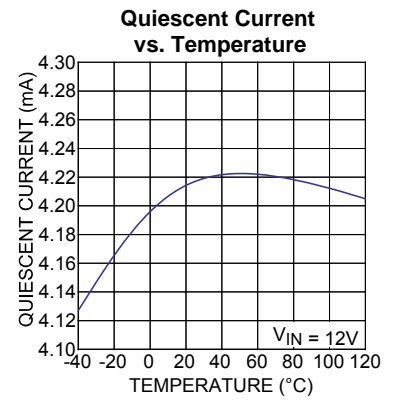
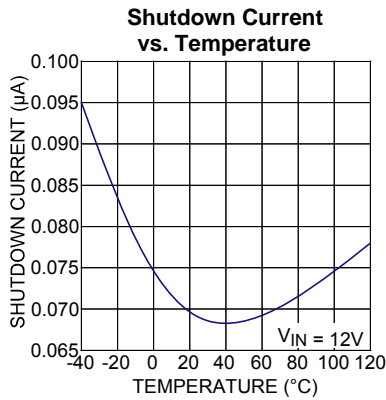
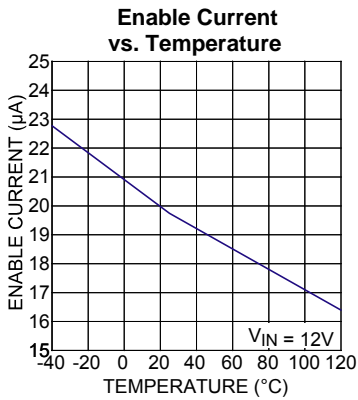
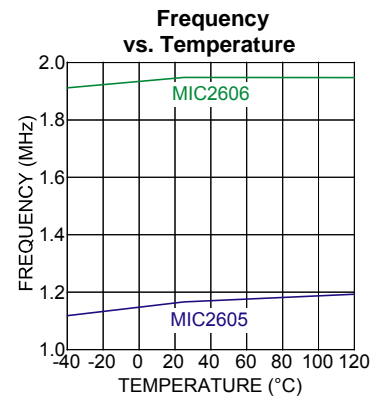
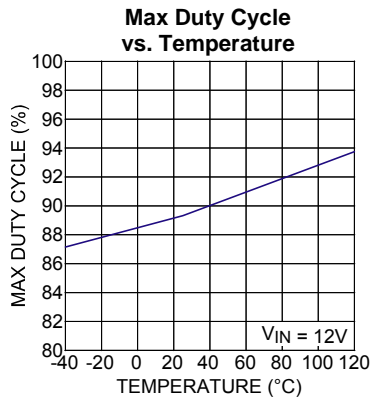
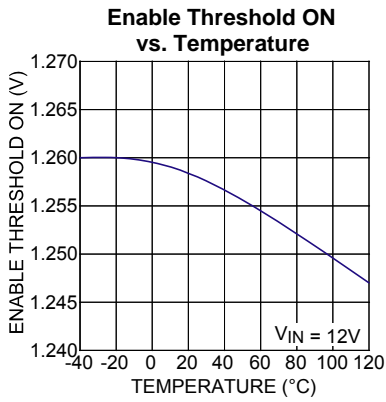

## Functional Characteristics

**Enable Turn-On**

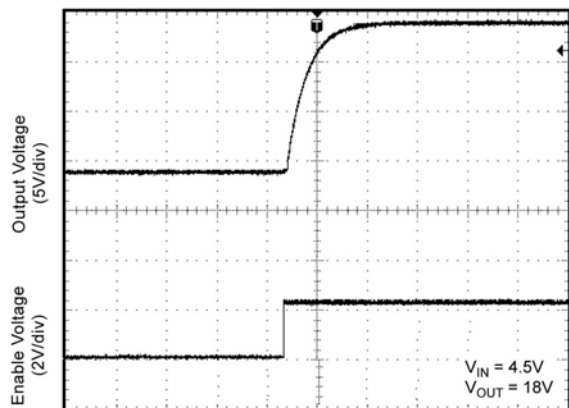

Time (4ms/div)

**Input Turn-On**

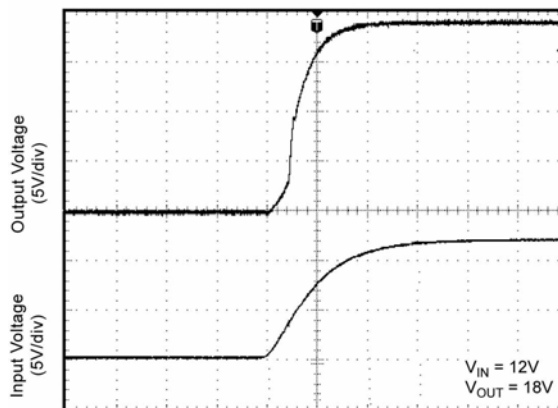

Time (4ms/div)

**Ripple Waveform**

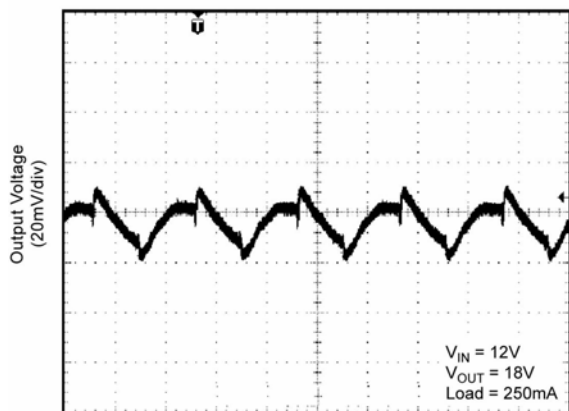

Time (400ns/div)

**Load Transient**

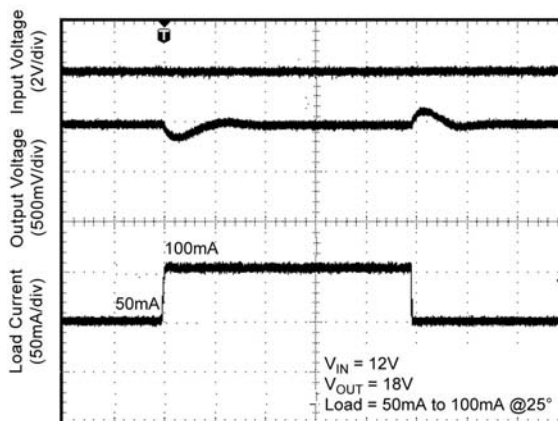

Time (100µs/div)

### Functional Diagram

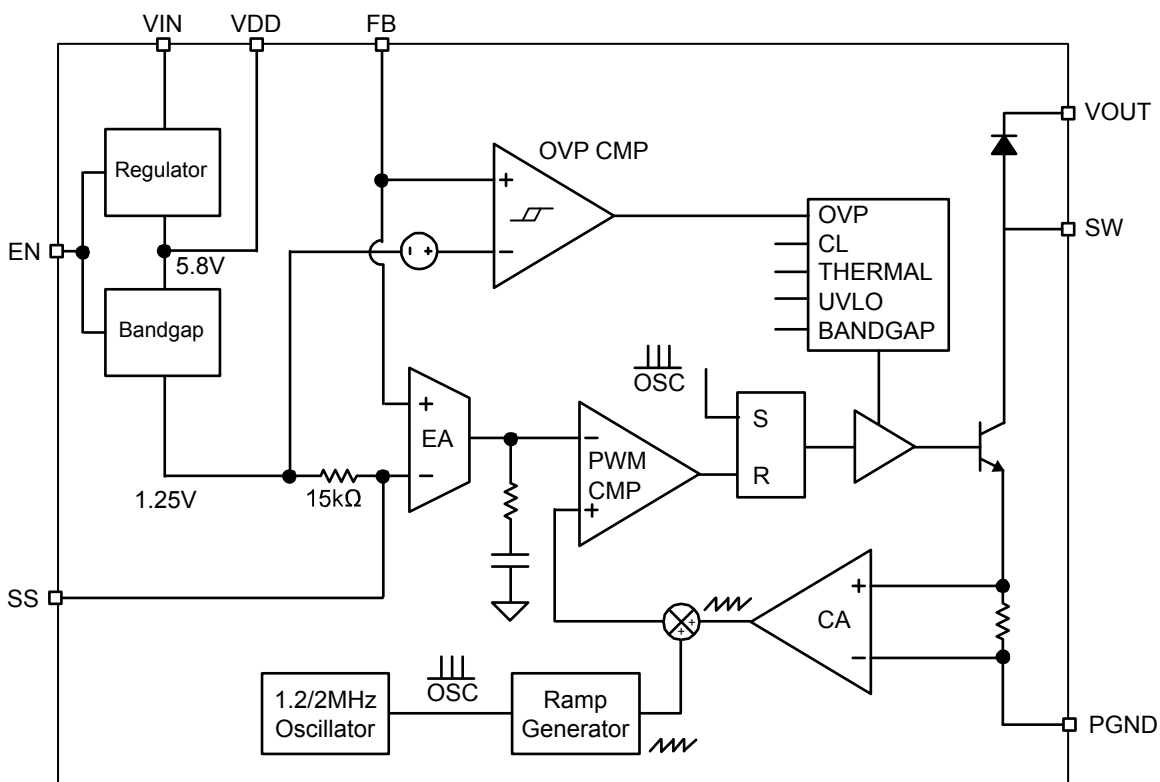

Figure 1. MIC2605/6 Block Diagram



## Functional Description

The MIC2605/6 is a constant frequency, PWM current mode boost regulator. The block diagram is shown in Figure 1. The MIC2605/6 is composed of an oscillator, slope compensation ramp generator, current amplifier,  $g_m$  error amplifier, PWM generator, and a 0.5A bipolar output transistor. The oscillator generates a 1.2MHz/2MHz clock. The clock's two functions are to trigger the PWM generator that turns on the output transistor and to reset the slope compensation ramp generator. The current amplifier is used to measure the switch current by amplifying the voltage signal from the internal sense resistor. The output of the current amplifier is summed with the output of the slope compensation ramp generator. This summed current-loop signal is fed to one of the inputs of the PWM generator.

The  $g_m$  error amplifier measures the feedback voltage through the external feedback resistors and amplifies the error between the detected signal and the 1.25V reference voltage. The output of the  $g_m$  error amplifier provides the voltage-loop signal that is fed to the other input of the PWM generator. When the current-loop signal exceeds the voltage-loop signal, the PWM generator turns off the bipolar output transistor. The next clock period initiates the next switching cycle, maintaining the constant frequency current-mode PWM control.

## Pin Description

### VIN

VIN provides power to the MOSFETs for the switch mode regulator section. Due to the high switching speeds, a 1 $\mu$ F capacitor is recommended close to VIN and the power ground (PGND) pin for bypassing. Please refer to layout recommendations.

### VDD

The VDD pin supplies the power to the internal power to the control and reference circuitry. The VDD is powered from VIN. A small 0.1 $\mu$ F capacitor is recommended for bypassing.

### EN

The enable pin provides a logic level control of the output. In the off state, supply current of the device is greatly reduced (typically <0.1 $\mu$ A). Also, in the off state, the output drive is placed in a "tri-stated" condition, where bipolar output transistor is in an "off" or non-conducting state. Do not drive the enable pin above the supply voltage.

### SS

The SS pin is the soft start pin which allows the monotonic buildup of output when the MIC2605/6 comes up during turn on. The SS pin gives the designer the flexibility to have a desired soft start by placing a capacitor SS to ground. A 0.1 $\mu$ F capacitor is used for in the circuit.

### FB

The feedback pin (FB) provides the control path to control the output. For fixed output controller output is directly connected to feedback (FB) pin.

### SW

The switch (SW) pin connects directly to the inductor and provides the switching current necessary to operate in PWM mode. Due to the high speed switching and high voltage associated with this pin, the switch node should be routed away from sensitive nodes.

### PGND

Power ground (PGND) is the ground path for the high current PWM mode. The current loop for the power ground should be as small as possible and separate from the Analog ground (AGND) loop. Refer to the layout considerations for more details.

### VOUT

VOUT pin is the cathode of pin of internal schottky diode. This pin is connected to output cap. At least 1 $\mu$ F cap is recommended very close to the VOUT pin and PGND.

## Application Information

### DC-to-DC PWM Boost Conversion

The MIC2605/6 is a constant frequency boost converter. It operates by taking a DC input voltage and regulating a higher DC output voltage. Figure 2 shows a typical circuit. Boost regulation is achieved by turning on an internal switch, which draws current through the inductor (L1). When the switch turns off, the inductor's magnetic field collapses, causing the current to be discharged into the output capacitor through an internal Schottky diode. Voltage regulation is achieved through pulse-width modulation (PWM).

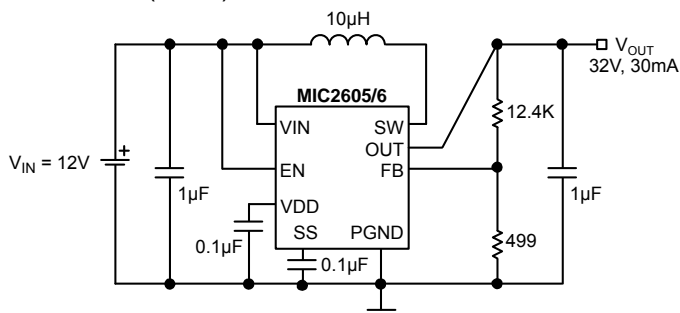

Figure 2. Typical Application Circuit

### Duty Cycle Considerations

Duty cycle refers to the switch on-to-off time ratio and can be calculated as follows for a boost regulator:

$$D = 1 - \frac{V_{IN}}{V_{OUT}}$$

The duty cycle required for voltage conversion should be less than the maximum duty cycle of 85%. Also, in light load conditions where the input voltage is close to the output voltage, the minimum duty cycle can cause pulse skipping. This is due to the energy stored in the inductor causing the output to overshoot slightly over the regulated output voltage. During the next cycle, the error amplifier detects the output as being high and skips the following pulse. This effect can be reduced by increasing the minimum load or by increasing the inductor value. Increasing the inductor value reduces peak current, which in turn reduces energy transfer in each cycle.

### Overvoltage Protection

For the MIC2605/6 there is an over voltage protection function. If the output voltage overshoots the set voltage by 15% when feedback is high during input higher than output, turn on, load transients, line transients, load disconnection etc. the MIC2605/6 OVP ckt will shut the switch off saving itself and other sensitive circuitry downstream.

## Component Selection

### Inductor

Inductor selection is a balance between efficiency, stability, cost, size, and rated current. For most applications, a 10µH is the recommended inductor value; it is usually a good balance between these considerations. Large inductance values reduce the peak-to-peak ripple current, affecting efficiency. This has an effect of reducing both the DC losses and the transition losses. There is also a secondary effect of an inductor's DC resistance (DCR). The DCR of an inductor will be higher for more inductance in the same package size. This is due to the longer windings required for an increase in inductance. Since the majority of input current (minus the MIC2605/6 operating current) is passed through the inductor, higher DCR inductors will reduce efficiency. To maintain stability, increasing inductor size will have to be met with an increase in output capacitance. This is due to the unavoidable "right half plane zero" effect for the continuous current boost converter topology. The frequency at which the right half plane zero occurs can be calculated as follows:

$$FRHPZ = \frac{(D)^2 \cdot V_o}{2 \cdot \pi \cdot L \cdot I_o}$$

The right half plane zero has the undesirable effect of increasing gain, while decreasing phase. This requires that the loop gain is rolled off before this has significant effect on the total loop response. This can be accomplished by either reducing inductance (increasing RHPZ frequency) or increasing the output capacitor value (decreasing loop gain).

### Output Capacitor

Output capacitor selection is also a trade-off between performance, size, and cost. Increasing output capacitance will lead to an improved transient response, but also an increase in size and cost. X5R or X7R dielectric ceramic capacitors are recommended for designs with the MIC2605/6. Y5V values may be used, but to offset their tolerance over temperature, more capacitance is required.

### Input capacitor

A minimum 1µF ceramic capacitor is recommended for designing with the MIC2605/6. Increasing input capacitance will improve performance and greater noise immunity on the source. The input capacitor should be as close as possible to the inductor and the MIC2605/6, with short traces for good noise performance.

**Feedback Resistors**

The MIC2605/6 utilizes a feedback pin to compare the output to an internal reference. The output voltage is adjusted by selecting the appropriate feedback resistor network values. The R2 resistor value must be less than or equal to 1kΩ ( $R2 \leq 1k\Omega$ ). The desired output voltage can be calculated as follows:

$$V_{OUT} = V_{REF} \cdot \left( \frac{R1}{R2} + 1 \right)$$

where  $V_{REF}$  is equal to 1.25V.

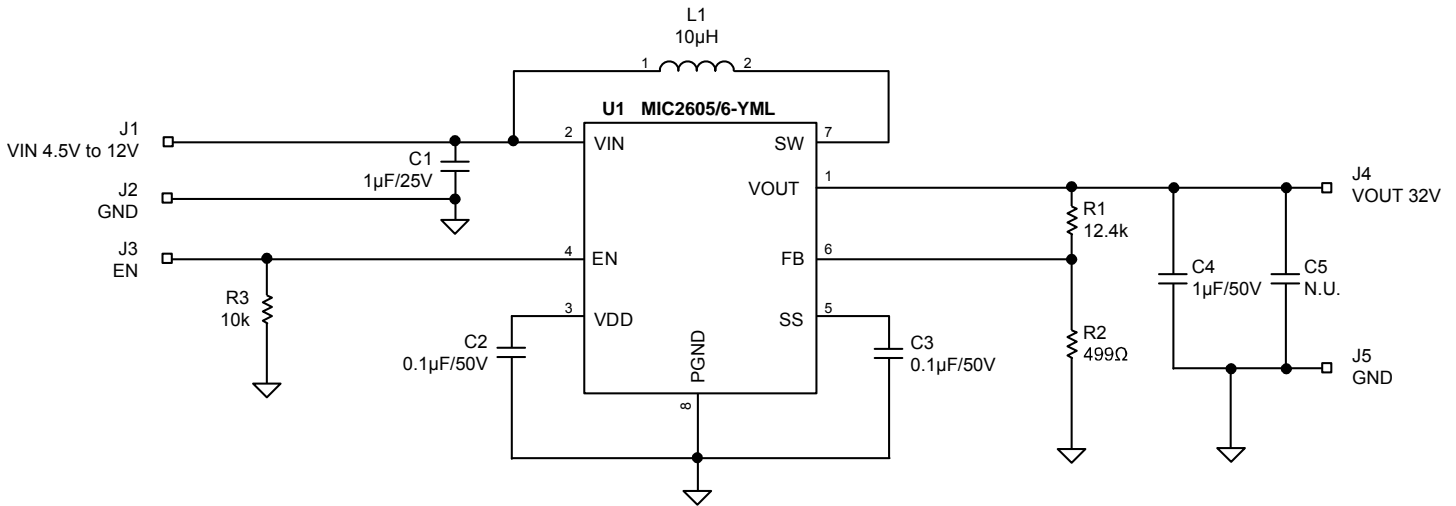

**Bill of Materials**

Item	Part Number	Manufacturer	Description	Qty.
C1	C1608X5R1E105K	TDK <sup>(1)</sup>	Capacitor, 1µF, 25V, X5R, Size 0603	1
	06033D105MAT	AVX <sup>(2)</sup>	Capacitor, 1µF, 25V, X5R, Size 0603	
	08055D105MAT	AVX <sup>(2)</sup>	Capacitor, 1µF, 50V, X5R, Size 0805	
C2	VJ0603Y104KXAAT	Vishay <sup>(3)</sup>	Capacitor, 0.1µF, 50V, X7R, 0603	1
	06035C104MAT	AVX <sup>(2)</sup>	Capacitor, 0.1µF, 50V, X7R, 0603	
	GRM188R71C104KA01D	Murata <sup>(4)</sup>	Capacitor, 0.1µF, 16V, X7R, 0603	
C3	VJ0603Y104KXAAT	Vishay <sup>(3)</sup>	Capacitor, 0.1µF, 50V, X7R, 0603	1
	06035C104MAT	AVX <sup>(2)</sup>	Capacitor, 0.1µF, 50V, X7R, 0603	
	GRM188R71C104KA01D	Murata <sup>(4)</sup>	Capacitor, 0.1µF, 16V, X7R, 0603	
C4	08055D105MAT	AVX <sup>(2)</sup>	Capacitor, 1µF, 50V, X5R, Size 0805	1
C5	N.U.	-----	-----	1
L1	LQH43CN100K03	Murata <sup>(4)</sup>	10µH, 0.65mA, DCR 240mΩ	1
	VLCF4020T-100MR85	TDK <sup>(1)</sup>	10uH, 0.85A-1.22A, DCR 120mΩ	
R1	CRCW06031242FKEA	Vishay Dale <sup>(3)</sup>	Resistor, 12.4k, 1%, 1/10W, Size 0603	1
R2	CRCW06034990FKEA	Vishay Dale <sup>(3)</sup>	Resistor, 499Ω, 1%, 1/10W, Size 0603	1
R3	CRCW060310K0FKEA	Vishay Dale <sup>(3)</sup>	Resistor, 10k, 1%, 1/10W, Size 0603	1
U1	<b>MIC2605/6-YML</b>	<b>Micrel, Inc.<sup>(5)</sup></b>	<b>0.5A, 1.2MHz/2MHz Wide Input Range Integrated Switch Boost Regulator</b>	<b>1</b>

**Notes:**

1. TDK: [www.tdk.com](http://www.tdk.com)
2. AVX: [www.avx.com](http://www.avx.com)
3. Vishay: [www.vishay.com](http://www.vishay.com)
4. Murata: [www.murata.com](http://www.murata.com)
6. Micrel, Inc.: [www.micrel.com](http://www.micrel.com)

### PCB Layout Recommendations

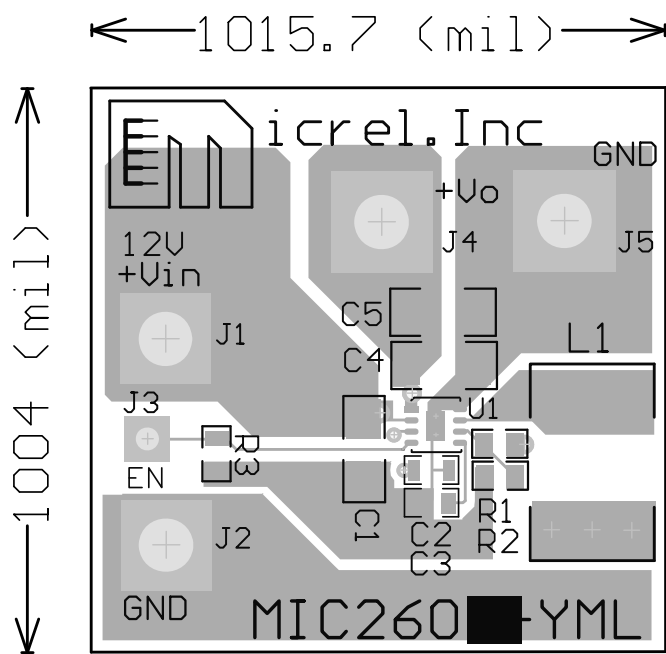

Top Layer

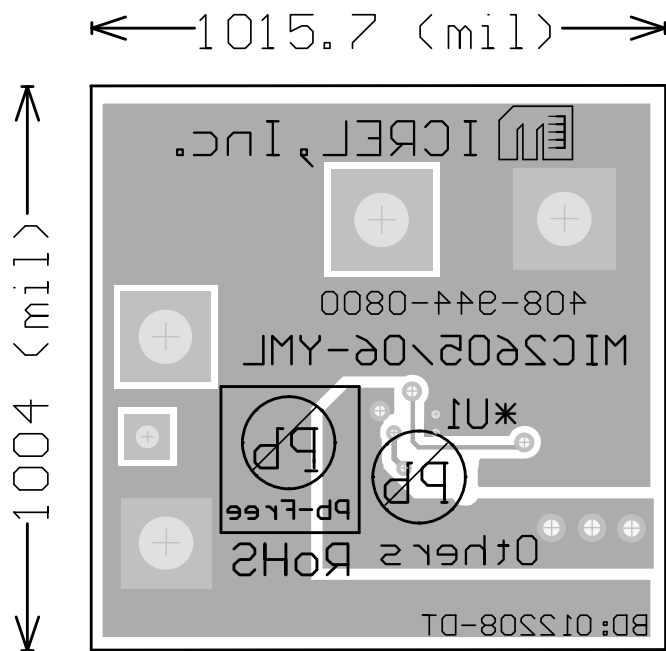

Bottom Layer

### Package Information

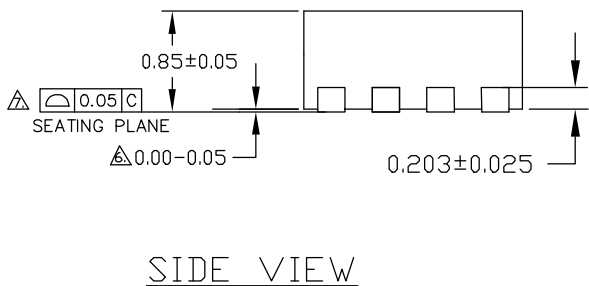
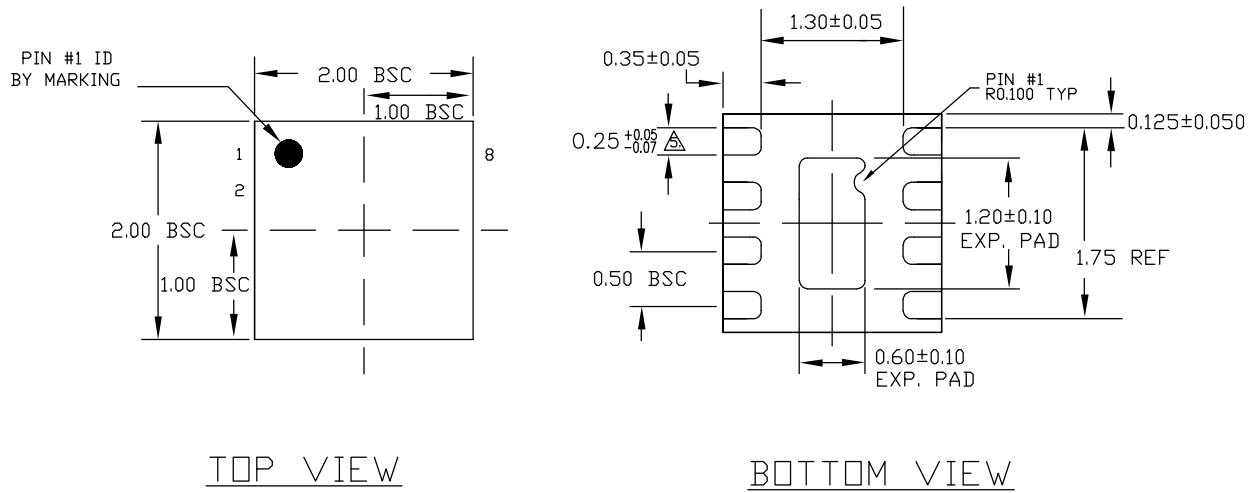

- NOTE:
1. ALL DIMENSIONS ARE IN MILLIMETERS.
  2. MAX. PACKAGE WARPAGE IS 0.05 mm.
  3. MAXIMUM ALLOWABLE BURRS IS 0.076 mm IN ALL DIRECTIONS.
  4. PIN #1 ID ON TOP WILL BE LASER/INK MARKED.
- △ DIMENSION APPLIES TO METALIZED TERMINAL AND IS MEASURED BETWEEN 0.20 AND 0.25 mm FROM TERMINAL TIP.
  - △ APPLIED ONLY FOR TERMINALS.
  - △ APPLIED FOR EXPOSED PAD AND TERMINALS.

### 8-Pin 2mm x 2mm MLF® (ML)

**MICREL, INC. 2180 FORTUNE DRIVE SAN JOSE, CA 95131 USA**  
 TEL +1 (408) 944-0800 FAX +1 (408) 474-1000 WEB <http://www.micrel.com>

The information furnished by Micrel in this data sheet is believed to be accurate and reliable. However, no responsibility is assumed by Micrel for its use. Micrel reserves the right to change circuitry and specifications at any time without notification to the customer.

Micrel Products are not designed or authorized for use as components in life support appliances, devices or systems where malfunction of a product can reasonably be expected to result in personal injury. Life support devices or systems are devices or systems that (a) are intended for surgical implant into the body or (b) support or sustain life, and whose failure to perform can be reasonably expected to result in a significant injury to the user. A Purchaser's use or sale of Micrel Products for use in life support appliances, devices or systems is a Purchaser's own risk and Purchaser agrees to fully indemnify Micrel for any damages resulting from such use or sale.

© 2008 Micrel, Incorporated.