

High-Current Low-Dropout Adjustable Regulator

General Description

The MIC29302WU is a high current, high accuracy and low-dropout voltage regulator. This regulator features 300mV to 370mV (full load) dropout voltage and very low ground current. Designed for high current load, the device also finds applications in lower current, extremely low dropout-critical systems, where its tiny dropout voltage and ground current value are important attributes.

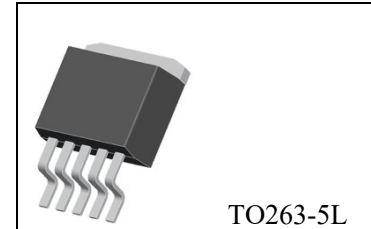

The MIC29302WU is fully protected against over-current fault, reversed input polarity, reversed lead insertion, over-temperature operation, and positive and negative transient voltage spikes.

On the MIC29302WU, the ENABLE pin may be tied to V_{IN} if it is not required for ON/OFF control.

The MIC29302WU is available in TO263-5L package.

Features

- High Current Capability of 3A
- Low-Dropout Voltage of 350mV at Full Load
- Low Ground Current
- Accurate 1% Guaranteed Tolerance
- Extremely Fast Transient Response
- Reverse-Battery and “Load Dump” Protection
- Zero-Current Shutdown Mode
- Also Characterized For Smaller Loads with Industry-Leading Performance Specifications
- Adjustable Version

Applications

- Battery Powered Equipment
- High-Efficiency “Green” Computer Systems
- Automotive Electronics
- High-Efficiency Linear Power Supplies
- High-Efficiency Post-Regulator for Switching Supply

Functional Block Diagram

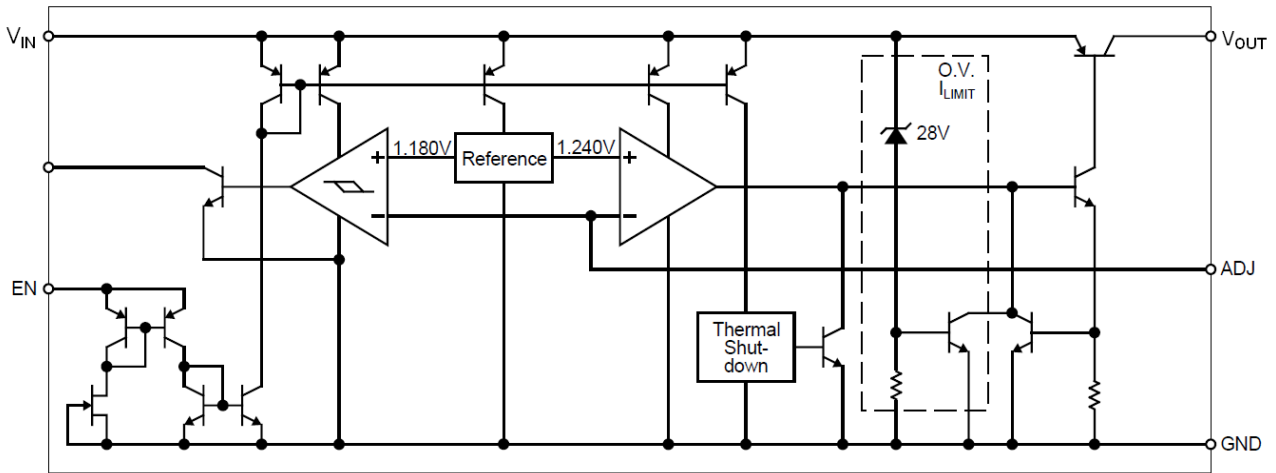

Pin Configuration

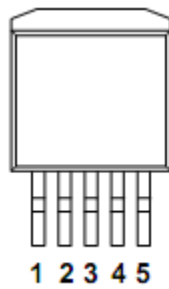

Pin Description

Pin Number	Pin Name	Function Description
1	EN	Enable pin
2	V _{IN}	Power supply
3	GND	Ground
4	V _{OUT}	Output
5	ADJ	Adjustable pin

Absolute Maximum Ratings

Parameter Name	Symbol	Value	Unit
Power Dissipation	P_D	Internally Limited	
Input Supply Voltage (*1)	V_{IN}	-20~+50	V
Lead Temperature (soldering, 5 seconds)	T_{LEAD}	260	°C
Operating Junction Temperature	T_{OPR}	-40~+125	°C
Storage Temperature Range	T_{STG}	-55~+150	°C
Thermal Resistance(JC)	θ_{JC}	2	°C/W

* 1: Maximum positive supply voltage of 50V must be of limited duration (<100msec) and duty cycle ($\leq 1\%$).

The maximum continuous supply voltage is 26V.

Recommended Operating Conditions

Parameter Name	Symbol	Value	Unit
Maximum Operating Input Voltage	V_{IN}	26	V

Electrical Characteristics

All measurements at $T_J = 25^\circ\text{C}$ unless otherwise noted.

Bold values are guaranteed across the operating temperature range.

Adjustable versions is programmed to 5.0V.

Parameter Name	Test Conditions	Min.	Typ.	Max.	Units
Output Voltage	$I_O = 10\text{mA}$	-1		1	%
	$10\text{mA} \leq I_O \leq I_{FL}$, $(V_{OUT} + 1\text{V}) \leq V_{IN} \leq 26\text{V}$ (*2)	-2		2	%
Line Regulation	$I_O = 10\text{mA}$, $(V_{OUT} + 1\text{V}) \leq V_{IN} \leq 26\text{V}$		0.06	0.5	%
Load Regulation	$V_{IN} = V_{OUT} + 5\text{V}$, $10\text{mA} \leq I_{OUT} \leq I_{FULLLOAD}$ (*2,3)		0.2	1	%
$\frac{\Delta V_O}{\Delta T}$	Output Voltage (*3) Temperature Coefficient		20	100	ppm/°C
Dropout Voltage	$I_O = 100\text{mA}$		80	175	mV
	$I_O = 1.5\text{A}$	$\Delta V_{OUT} = -1\%$ (*4)	250	600	
	$I_O = 3\text{A}$		370		
Ground Current	$I_O = 1.5\text{A}$, $I_O = 3\text{A}$	$V_{IN} = V_{OUT} + 1\text{V}$ (*5)	10 37	35	mA
Ground Pin Current at Dropout	$V_{IN} = 0.5\text{V}$ less than specified V_{OUT} $I_{OUT} = 10\text{mA}$		1.7		mA
Current Limit	$V_{OUT} = 0\text{V}$ (*6)		4.5	5.0	A
Output Noise Voltage(10Hz to 100kHz) $I_L = 100\text{mA}$	$C_L = 10\mu\text{F}$		400		$\mu\text{V(rms)}$
	$C_L = 33\mu\text{F}$		260		

Reference					
Reference Voltage		1.228 1.215	1.240	1.252 1.265	V V
Reference Voltage	(*7)	1.203		1.277	V
Adjust Pin Bias Current			40	80 120	nA
Reference Voltage Temperature Coefficient	(*8)		20		ppm/°C
Adjust Pin Bias Current Temperature Coefficient			0.1		nA/°C
Enable Input					
Input Logic Voltage Low (OFF) High (ON)		2.4		0.8	V
Enable Pin Input Current	V _{EN} =26V		100	600 750	μA
	V _{EN} =0.8V			1 2	μA
Regulator Output Current in Shutdown	(*9)		10	500	μA

* 2: Full Load current (I_{FL}) is defined as 3A.

* 3: Output voltage temperature coefficient is defined as the worst case voltage change divided by the total temperature range.

* 4: Dropout voltage is defined as the input-to-output differential when the output voltage drops to 99% of its nominal value with V_{OUT} + 1V applied to V_{IN}.

* 5: Ground pin current is the regulator quiescent current. The total current drawn from the source is the sum of the load current plus the ground pin current.

* 6: V_{IN} = V_{OUT} (nominal) + 1V. For example, use V_{IN} = 4.3V for a 3.3V regulator or use 6V for a 5V regulator. Employ pulse-testing procedures to minimize temperature rise.

* 7: V_{REF} ≤ V_{OUT} ≤ (V_{IN} - 1 V), 2.3V ≤ V_{IN} ≤ 26V, 10mA < I_L ≤ I_{FL}, T_J ≤ T_{J MAX}.

* 8: Thermal regulation is defined as the change in output voltage at a time T after a change in power dissipation is applied, excluding load or line regulation effects. Specifications are for a 200mA load pulse at V_{IN} = 20V (a 4W pulse) for T = 10ms.

* 9: V_{EN} ≤ 0.8V and V_{IN} ≤ 26V, V_{OUT} = 0.

Typical Application

Below is adjustable output voltage configuration. For best results, the total series resistance should be small enough to pass the minimum regulator load current.

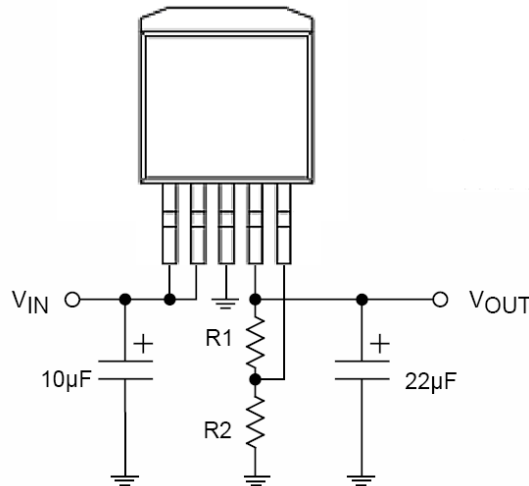

$$V_{OUT} = 1.240V \times [1 + (R1/R2)]$$

Application Information

The MIC29302WU is a high performance low-dropout voltage adjustable regulator suitable for all moderate to high-current voltage regulator application. Its 300mV to 400mV dropout voltage at full load make them especially valuable in battery powered systems and as high efficiency noise filters in “post-regulator” applications. Unlike older NPN-pass transistor designs, where the minimum dropout voltage is limited by the base-emitter voltage drop and collector-emitter saturation voltage, dropout performance of the PNP output of this device is limited merely by the low V_{CE} saturation voltage.

A trade-off for the low dropout voltage is a varying base drive requirement. The MIC29302WU is a fully protected from damage due to fault condition. Current limiting is provided. This limiting is linear; output current under over-load conditions is constant. Thermal shutdown disables the device when the die temperature exceeds the 125°C maximum safe operating temperature. Transient protection allows device (and load) survival even when the input voltage spikes between -20V and +50V. When the input voltage exceeds about 35V to 40V, the over-voltage sensor temporarily disables the regulator. The output structure of this regulator allows voltages in excess of the desired output voltage to be applied without reverse current flow. MIC29302WU version offers a logic level ON/OFF control: when disabled, the devices draw nearly zero current.

Thermal Design

Linear regulators are simple to use. The most complicated design parameters to consider are thermal characteristics. Thermal design requires the following application-specific parameters:

- Maximum ambient temperature, T_A
- Output Current, I_{OUT}
- Output Voltage, V_{OUT}
- Input Voltage, V_{IN}

First, we calculate the power dissipation of the regulator from these numbers and the device parameters from this datasheet.

$$P_D = I_{OUT}(1.01V_{IN} - V_{OUT})$$

Where the ground current is approximated by 1% of I_{OUT} . Then the heat sink thermal resistance is determined with this formula:

$$\theta_{SA} = \frac{T_{JMAX} - T_A}{P_D} - (\theta_{JC} + \theta_{CS})$$

Where $T_{JMAX} \leq 125^\circ\text{C}$ and θ_{CS} is between 0 and 2°C/W .

The heat sink may be significantly reduced in applications where the minimum input voltage is known and is large compared with the dropout voltage. Use a series input resistor to drop excessive voltage and distribute the heat between this resistor and the regulator. The low dropout properties of regulators allow very significant reductions in regulator power dissipation and the associated heat sink without compromising performance. When this technique is employed, a capacitor of at least $0.1\mu\text{F}$ is needed directly between the input and regulator ground.

Capacitor Requirements

For stability and minimum output noise, a capacitor on the regulator output is necessary. The value of this capacitor is dependent upon the output current; lower currents allow smaller capacitors. MIC29302WU regulator is stable with the following minimum capacitor values at full load: $10\mu\text{F}$. This capacitor need not be an expensive low ESR type: aluminum electrolytics are adequate. In fact, extremely low ESR capacitors may contribute to instability. Tantalum capacitors are recommended for systems where fast load transient response is important.

Where the regulator is powered from a source with a high AC impedance, a $0.1\mu\text{F}$ capacitor connected between Input and GND is recommended. This capacitor should have good characteristics to above 250kHz .

Minimum Load Current

The MIC29302WU regulator is specified between finite loads. If the output current is too small, leakage currents dominate and the output voltage rises. The following minimum load current swamps any expected leakage current across the operating temperature range: 7mA

Adjustable Regulator Design

The adjustable regulator version, MIC29302WU allows programming the output voltage anywhere between 1.25V and the 26V maximum operating rating of the family. Two resistors are used. Resistors can be quite large, up to 1MΩ, because of the very high input impedance and low bias current of the sense comparator: The resistor values are calculated by:

$$R_1 = R_2 \left(\frac{V_{OUT}}{1.240} - 1 \right)$$

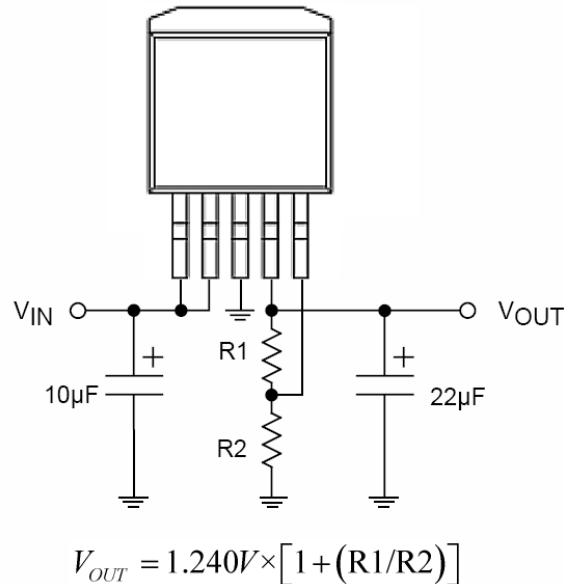

Fig. Adjustable Regulator with Resistors

Where V_{OUT} is the desired output voltage. Figure right shows component definition. Applications with widely varying load currents may scale the resistors to draw the minimum load current required for proper operation (see above).

Enable Input

MIC29302WU versions feature an enable (EN) input that allows ON/OFF control of the device. Special design allows “zero” current drain when the device is disabled—only microamperes of leakage current flows. The EN input has TTL/CMOS compatible thresholds for simple interfacing with logic, or may be directly tied to $\leq 30V$. Enabling the regulator requires approximately 20µA of current.

Characteristic Curves

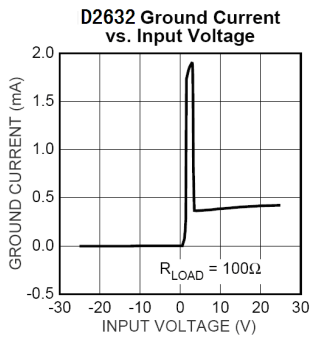
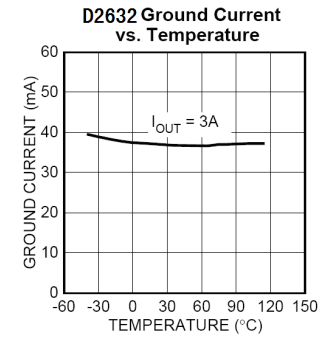
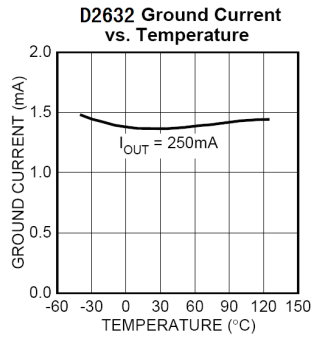
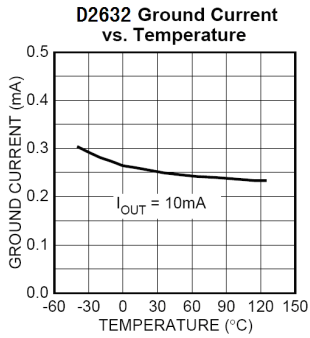
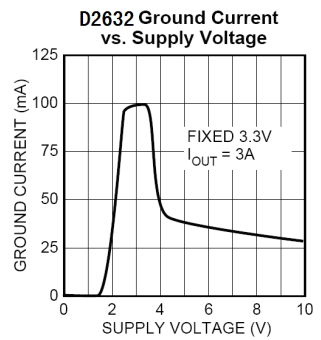
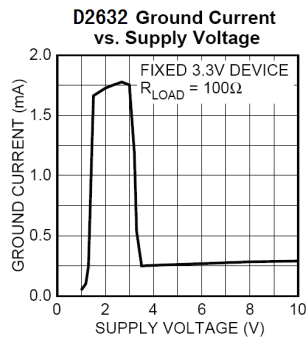
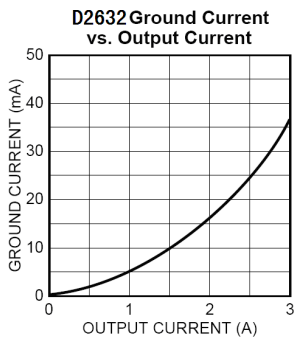
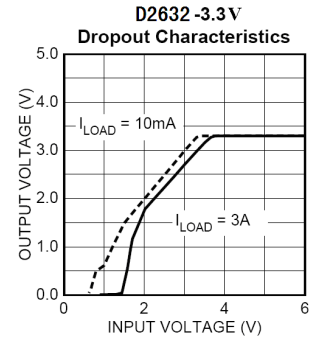
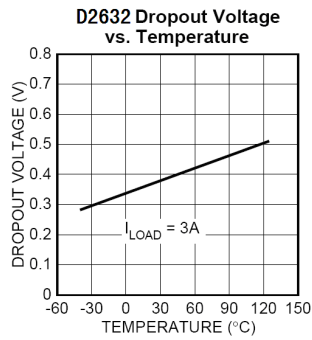
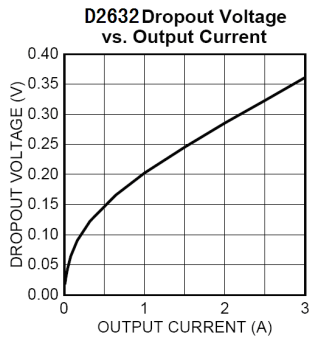

D2632 Enable Current vs. Temperature

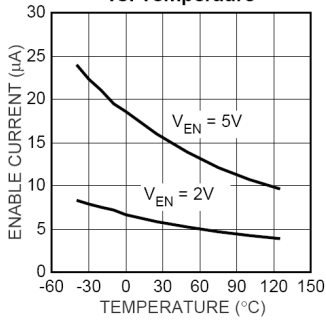

D2632 Load Transient

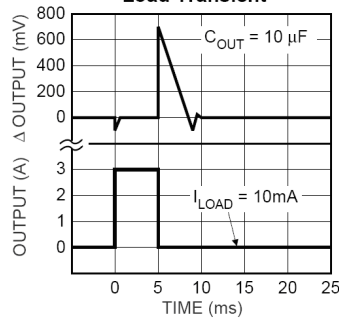

D2632 Load Transient

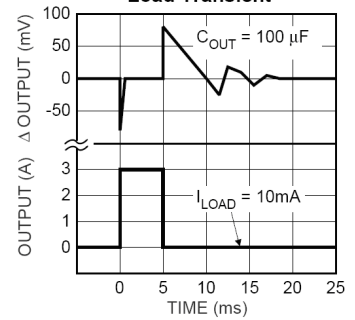

D2632 Adjust Pin Current vs. Temperature

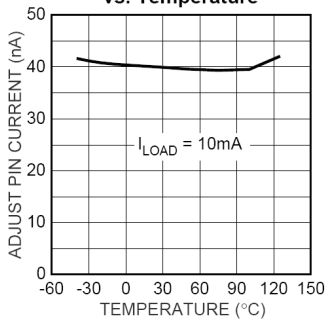

D2632 Line Transient

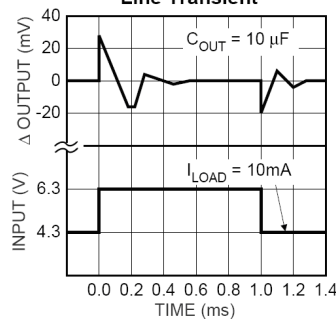

D2632 Line Transient

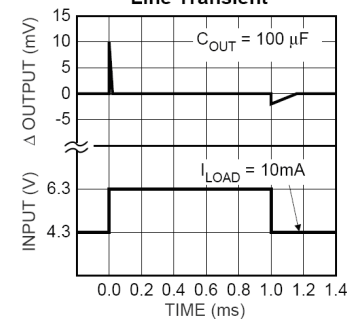

D2632 Output Impedance vs. Frequency

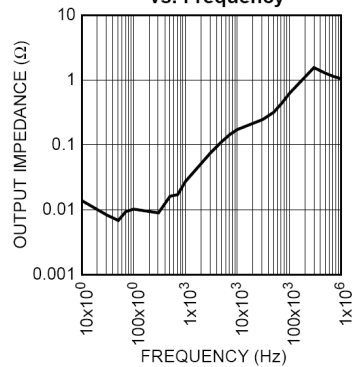

Outline Dimensions

