

3A High-Side Load Switch with Reverse Blocking

Features

- 1.5 mm × 1 mm 6-Ball WLCSP Package
- 14.5 mΩ $R_{DS(ON)}$
- 1.7V to 5.5V Input Voltage Range
- 3A Continuous Operating Current
- Reverse Current Flow Blocking (No “Body Diode”)
- Internal Level Shift for CMOS/TTL Control Logic
- Ultra-Low Quiescent Current
- Micropower Shutdown Current
- Soft-Start: MIC94161/4/5 (2.7 ms)
- Load Discharge Circuit: MIC94162/4
- Ultra-Fast Turn-Off Time
- Junction Operating Temperature from -40°C to $+125^{\circ}\text{C}$

Applications

- Solid State Drives (SSD)
- Smartphones and Tablets
- Personal Media Players (PMP)
- Ultra-Mobile PCs
- Portable Instrumentation
- GPS Modules
- Datacom Equipment

General Description

The MIC94161, MIC94162, MIC94163, MIC94164, and MIC94165 are a family of high-side load switches designed to operate from 1.7V to 5.5V input voltage. The load switch pass element is an internal 14.5 mΩ $R_{DS(ON)}$ N-Channel MOSFET that enables the device to support up to 3A of continuous current. Additionally, the load switch supports 1.5V logic level control and shutdown features in a tiny 1.5 mm × 1 mm 6-ball WLCSP package.

The MIC94161/2/3/4/5 provide reverse current protection when the device is disabled. The device will not allow the flow of current from the output to the input when the device is turned OFF. Additionally, the MIC94161 features overvoltage protection to protect the load when the input voltage is above 4.55V, as well as a precise enable threshold that keeps the MIC94161 in the default OFF state until the EN pin rises above 1.15V.

The MIC94161/2/3/4/5 operating voltage range makes them ideal for Lithium-ion and NiMH/NiCad/Alkaline battery powered systems, as well as non battery powered applications. The devices provide low quiescent current and low shutdown current to maximize battery life.

Package Type

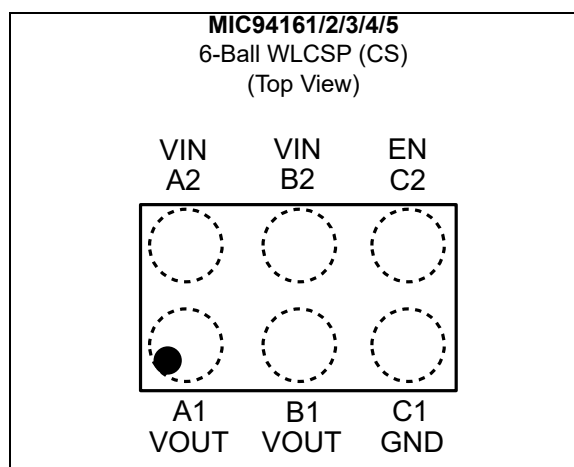

MIC94161/2/3/4/5

Typical Application Circuits

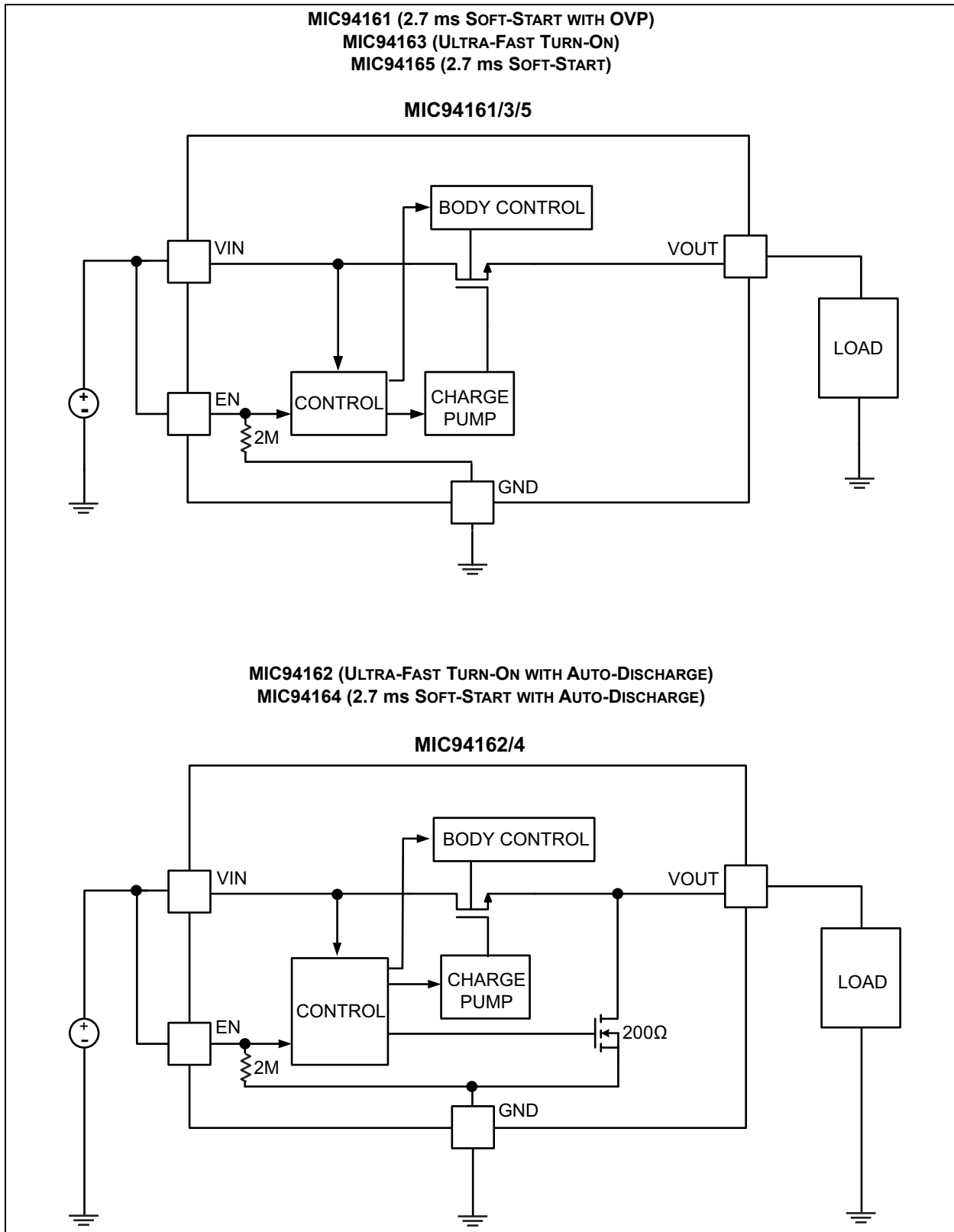

1.0 ELECTRICAL CHARACTERISTICS

Absolute Maximum Ratings †

Input Voltage (V_{IN})	-0.3V to +6V
Enable Voltage (V_{EN})	-0.3V to +6V
Continuous Drain Current (I_D) (Note 1)	±3A
ESD Rating (Note 2)	2 kV

Operating Ratings ††

Input Voltage (V_{IN})	+1.7V to +5.5V
----------------------------------	----------------

† **Notice:** Stresses above those listed under “Absolute Maximum Ratings” may cause permanent damage to the device. This is a stress rating only and functional operation of the device at those or any other conditions above those indicated in the operational sections of this specification is not intended. Exposure to maximum rating conditions for extended periods may affect device reliability.

†† **Notice:** The device is not guaranteed to function outside its operating ratings.

Note 1: With thermal contact to PCB (see Application Information).

2: Devices are ESD sensitive. Handling precautions are recommended. Human body model, 1.5 kΩ in series with 100 pF.

ELECTRICAL CHARACTERISTICS

Electrical Characteristics: $T_A = +25^\circ\text{C}$. **Bold** values valid for $-40^\circ\text{C} \leq T_A \leq +125^\circ\text{C}$, unless noted.

Parameter	Sym.	Min.	Typ.	Max.	Units	Conditions
General						
Operating Input Voltage Range	V_{IN}	1.7	—	5.5	V	—
Enable Threshold Voltage (MIC94161)	V_{ENTH}	1.15	—	1.5	V	$V_{IN} = 1.7\text{V to } 5.5\text{V}$; $I_{OUT} = 250\ \mu\text{A}$
Enable Threshold Voltage (MIC94162/3/4/5)		—	—	0.375	V	Logic Low, OFF; $V_{IN} = 1.8\text{V to } 5.5\text{V}$; $I_{OUT} = 250\ \mu\text{A}$; $-40^\circ\text{C} \geq T_J \leq +85^\circ\text{C}$
		1.2	—	—		Logic High, ON; $V_{IN} = 1.7\text{V to } 5.5\text{V}$; $I_{OUT} = 250\ \mu\text{A}$; $-40^\circ\text{C} \geq T_J \leq +85^\circ\text{C}$
Enable Input Current	I_{EN}	—	2	4	μA	$V_{IN} = V_{EN} = 3.6\text{V}$; $I_{OUT} = 0$
Quiescent Current (MIC94161)	I_Q	—	40	80	μA	$V_{IN} = V_{EN} = 3.6\text{V}$; $I_{OUT} = 0$
Quiescent Current (MIC94162/3)	I_Q	—	25	55	μA	$V_{IN} = V_{EN} = 3.6\text{V}$; $I_{OUT} = 0$
Quiescent Current (MIC94164/5)	I_Q	—	15	35	μA	$V_{IN} = V_{EN} = 3.6\text{V}$; $I_{OUT} = 0$
Shutdown Current	I_{SD}	—	0.1	1	μA	$V_{IN} = 5.5\text{V}$; $V_{EN} = 0\text{V}$; $I_{OUT} = \text{Open}$
OFF State Leakage Current	I_{LEAK}	—	0.1	1	μA	$V_{IN} = 5.5\text{V}$; $V_{EN} = 0\text{V}$; $I_{OUT} = \text{Short}$
Reverse Leakage Current (MIC94161/3/5)	I_{LEAKR}	—	0.1	1	μA	$V_{IN} = 0\text{V}$; $V_{OUT} = 5.5\text{V}$; $V_{EN} = 0\text{V}$

MIC94161/2/3/4/5

ELECTRICAL CHARACTERISTICS (CONTINUED)

Electrical Characteristics: $T_A = +25^\circ\text{C}$. **Bold** values valid for $-40^\circ\text{C} \leq T_A \leq +125^\circ\text{C}$, unless noted.

Parameter	Sym.	Min.	Typ.	Max.	Units	Conditions
N-Channel ON-Resistance	$R_{DS(ON)}$	—	14.5	—	m Ω	$V_{IN} = 5.5\text{V}; V_{EN} = 1.5\text{V}; I_{OUT} = 3\text{A}$
		—	15.5	—		$V_{IN} = 4.5\text{V}; V_{EN} = 1.5\text{V}; I_{OUT} = 3\text{A}$
		—	17.5	—		$V_{IN} = 3.6\text{V}; V_{EN} = 1.5\text{V}; I_{OUT} = 3\text{A}$
		—	21	—		$V_{IN} = 2.7\text{V}; V_{EN} = 1.5\text{V}; I_{OUT} = 3\text{A}$
		—	34	—		$V_{IN} = 1.8\text{V}; V_{EN} = 1.5\text{V}; I_{OUT} = 3\text{A}$
		—	40	—		$V_{IN} = 1.7\text{V}; V_{EN} = 1.5\text{V}; I_{OUT} = 3\text{A}$
Overvoltage Protection Threshold (MIC94161)	V_{OVP}	4.5	4.75	5	V	$V_{IN} = V_{EN}; I_{OUT} = 0; V_{IN}$ rising
Active Discharge Resistance (MIC94162/4)	R_{AD}	—	200	400	Ω	$V_{IN} = 3.6\text{V}; I_{TEST} = 1\text{ mA}; V_{EN} = 0\text{V}$
Timing Characteristics						
Turn-On Delay Time (MIC94162/3)	t_{ON}	—	10	—	μs	$V_{IN} = 3.6\text{V}; R_{LOAD} = 1.2\Omega; C_{OUT} = 200\ \mu\text{F}; V_{EN} = 1.5\text{V}$
Turn-On Rise Time (MIC94162/3)	t_R	—	60	—	μs	$V_{IN} = 3.6\text{V}; R_{LOAD} = 1.2\Omega; C_{OUT} = 200\ \mu\text{F}; V_{EN} = 1.5\text{V}$
Turn-On Delay Time (MIC94161/4/5)	t_{ON}	—	0.4	—	ms	$V_{IN} = 3.6\text{V}; R_{LOAD} = 1.2\Omega; C_{OUT} = 200\ \mu\text{F}; V_{EN} = 1.5\text{V}$
Turn-On Rise Time (MIC94161/4/5)	t_R	—	2.7	—	ms	$V_{IN} = 3.6\text{V}; R_{LOAD} = 1.2\Omega; C_{OUT} = 200\ \mu\text{F}; V_{EN} = 1.5\text{V}$
Turn-Off Delay Time	t_{OFF}	—	25	—	μs	$V_{IN} = 3.6\text{V}; R_{LOAD} = 1.2\Omega; C_{OUT} = 200\ \mu\text{F}; V_{EN} = 1.5\text{V}$
Turn-Off Fall Time	t_F	—	500	—	μs	$V_{IN} = 3.6\text{V}; R_{LOAD} = 1.2\Omega; C_{OUT} = 200\ \mu\text{F}; V_{EN} = 1.5\text{V}$

TEMPERATURE SPECIFICATIONS

Parameters	Sym.	Min.	Typ.	Max.	Units	Conditions
Temperature Ranges						
Junction Temperature Range	T_J	-40	—	+125	$^\circ\text{C}$	Note 1
Storage Temperature Range	T_S	-55	—	+150	$^\circ\text{C}$	—
Package Thermal Resistance						
Thermal Resistance, WLCSP 6-Ball	θ_{JA}	—	108	—	$^\circ\text{C}/\text{W}$	—

Note 1: Sustained junction temperatures above $+125^\circ\text{C}$ can impact the device reliability.

Timing Diagrams

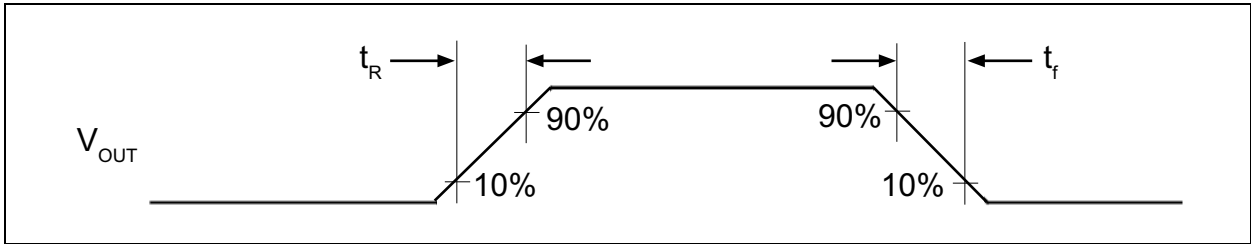

FIGURE 1-1: Output Voltage Rise and Fall Time Measurements.

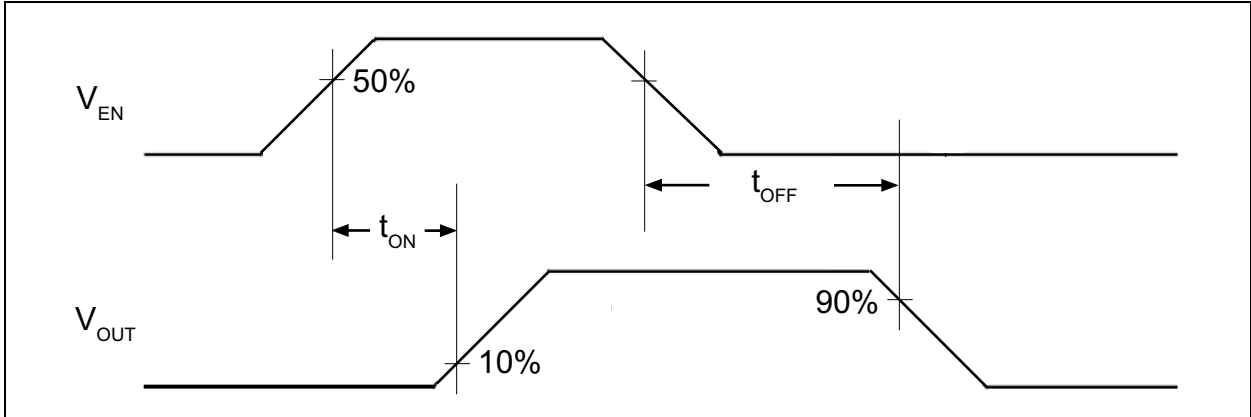

FIGURE 1-2: Output Voltage Turn On and Turn Off Measurements.

MIC94161/2/3/4/5

2.0 TYPICAL OPERATING CHARACTERISTICS

Note: The graphs and tables provided following this note are a statistical summary based on a limited number of samples and are provided for informational purposes only. The performance characteristics listed herein are not tested or guaranteed. In some graphs or tables, the data presented may be outside the specified operating range (e.g., outside specified power supply range) and therefore outside the warranted range.

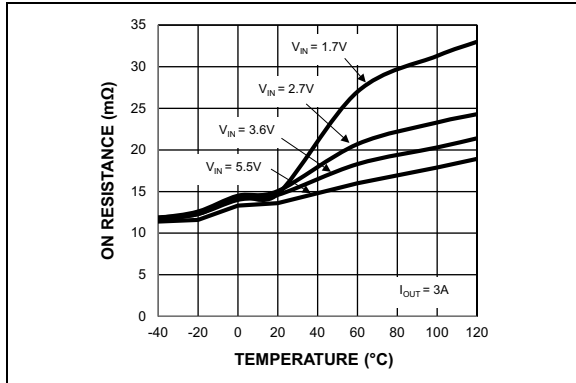

FIGURE 2-1: ON Resistance vs. Temperature.

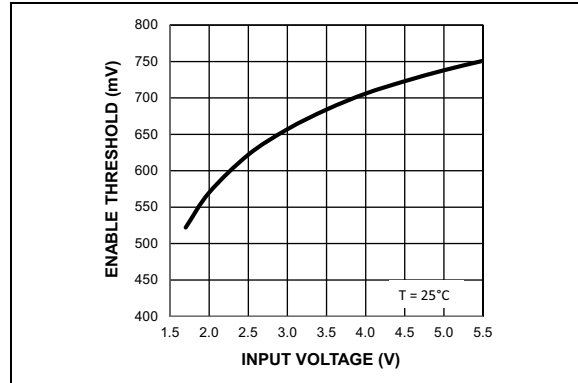

FIGURE 2-4: Enable Threshold vs. Input Voltage (MIC94162/3/4/5).

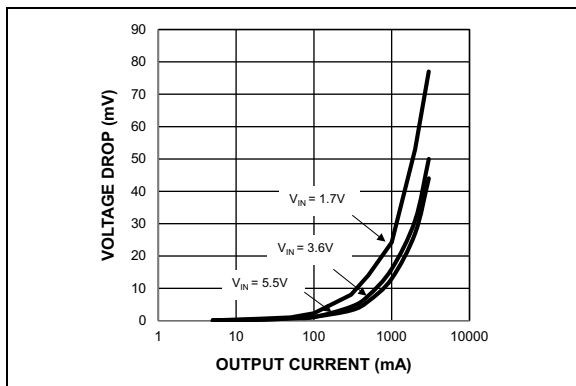

FIGURE 2-2: Voltage Drop vs. Output Current.

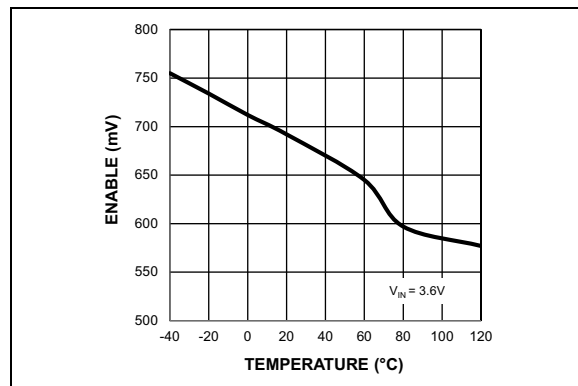

FIGURE 2-5: Enable Threshold vs. Temperature (MIC94162/3/4/5).

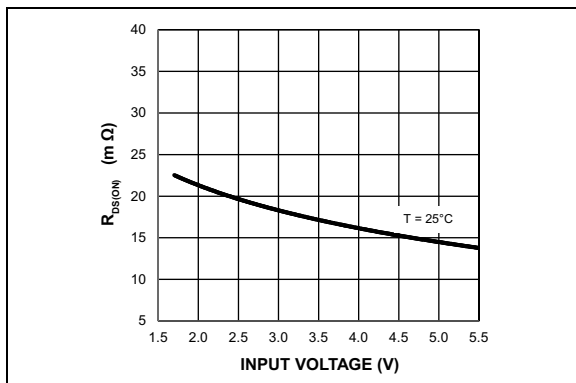

FIGURE 2-3: $R_{DS(ON)}$ vs. Input Voltage.

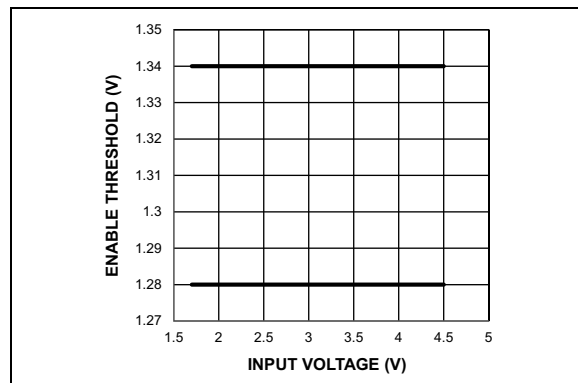

FIGURE 2-6: Enable Threshold vs. Input Voltage (MIC94161).

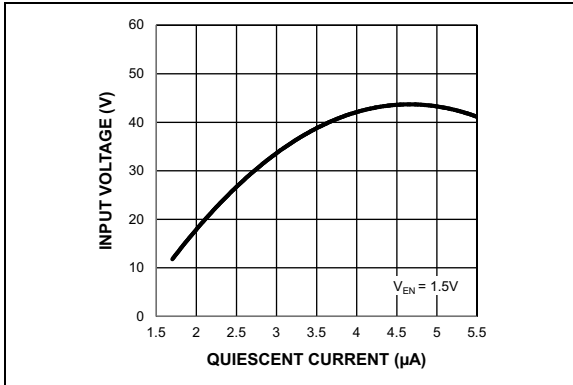

FIGURE 2-7: Quiescent Current vs. Input Voltage (MIC94161).

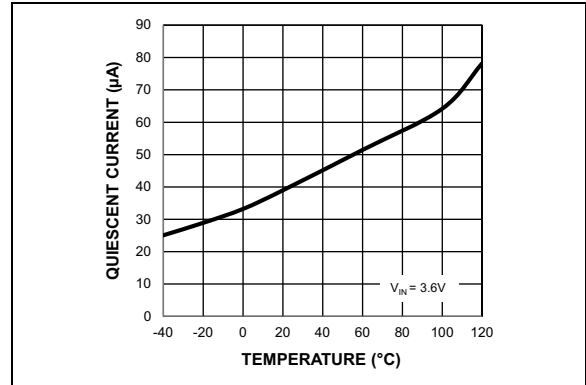

FIGURE 2-10: Quiescent Current vs. Temperature (MIC94161).

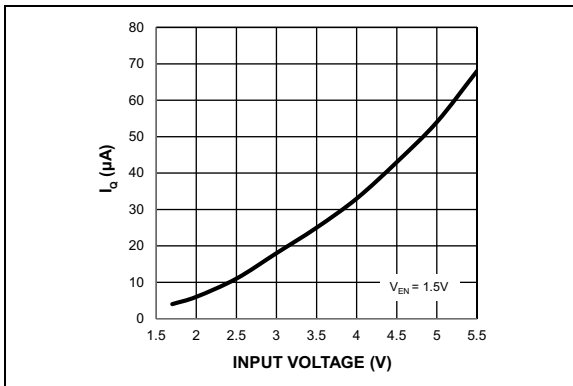

FIGURE 2-8: Quiescent Current vs. Input Voltage (MIC94162/3).

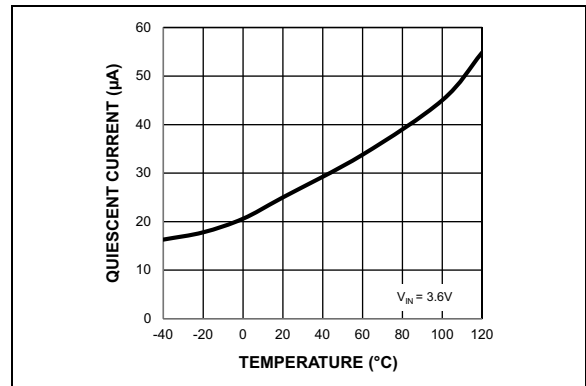

FIGURE 2-11: Quiescent Current vs. Temperature (MIC94162/3).

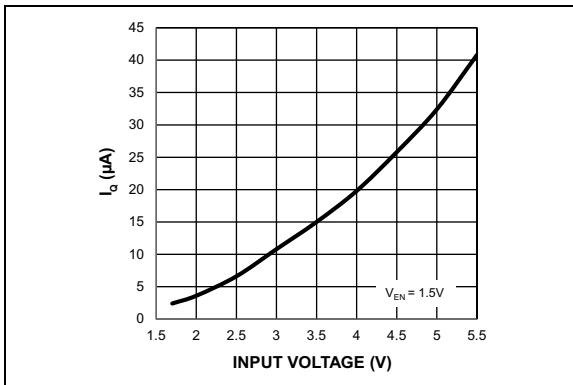

FIGURE 2-9: Quiescent Current vs. Input Voltage (MIC94164/5).

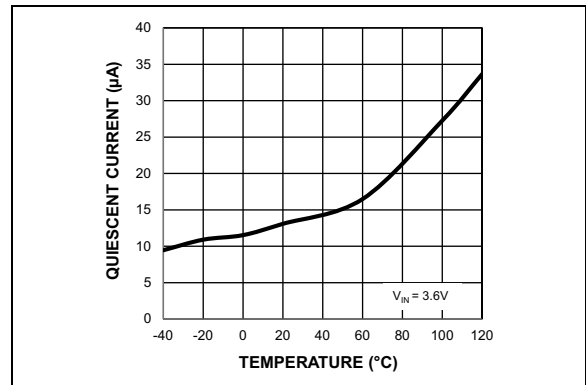

FIGURE 2-12: Quiescent Current vs. Temperature (MIC94164/5).

MIC94161/2/3/4/5

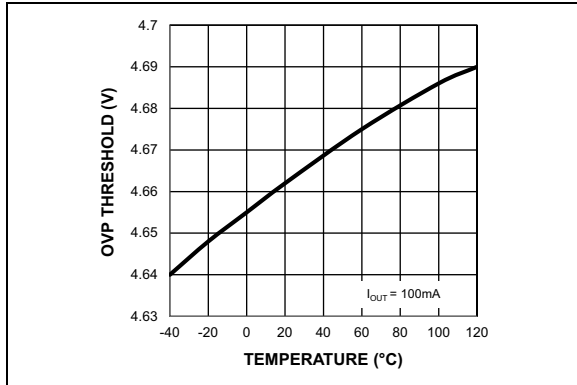

FIGURE 2-13: OVP Threshold vs. Temperature (MIC94161).

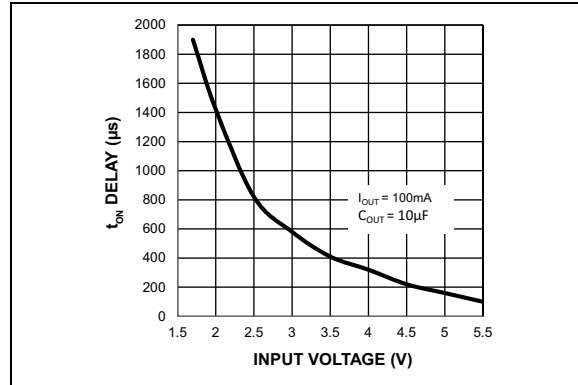

FIGURE 2-16: t_{ON} Delay vs. Input Voltage (MIC94161/4/5).

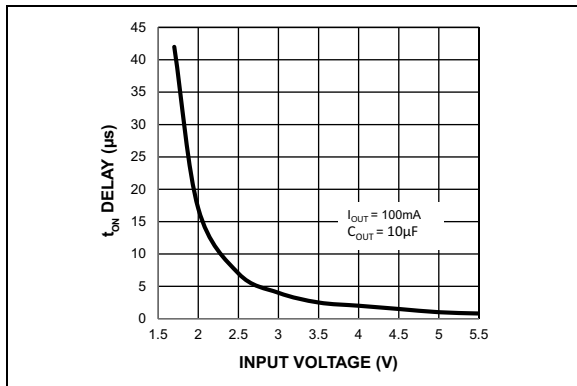

FIGURE 2-14: t_{ON} Delay vs. Input Voltage (MIC94162/3).

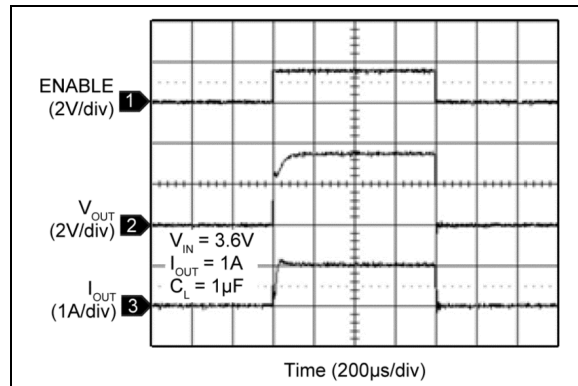

FIGURE 2-17: MIC94162/3 Start-Up ($I_{OUT} = 1A$).

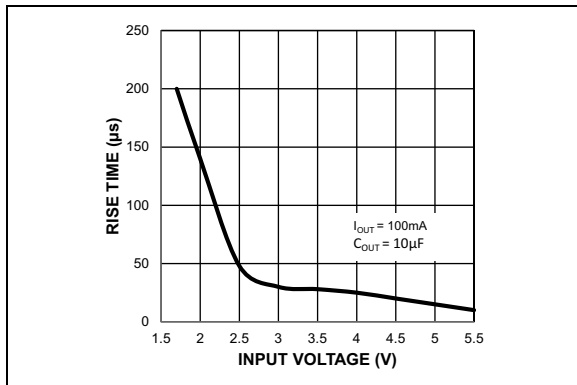

FIGURE 2-15: Rise Time vs. Input Voltage (MIC94162/3).

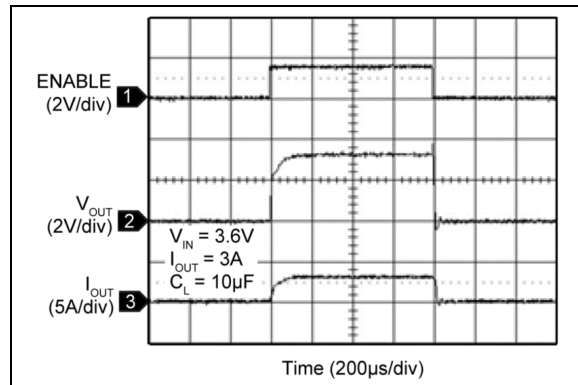

FIGURE 2-18: MIC94162/3 Start-Up ($I_{OUT} = 3A$).

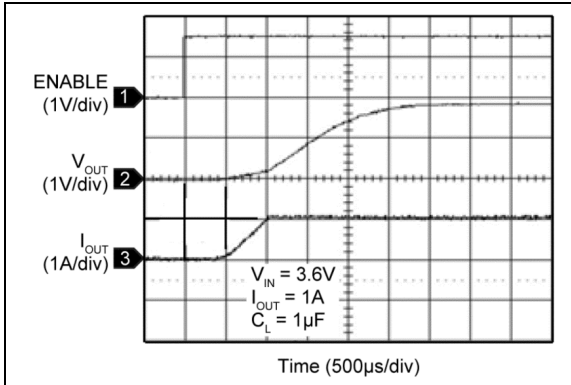

FIGURE 2-19: MIC94161/4/5 Start-Up ($I_{OUT} = 1A$).

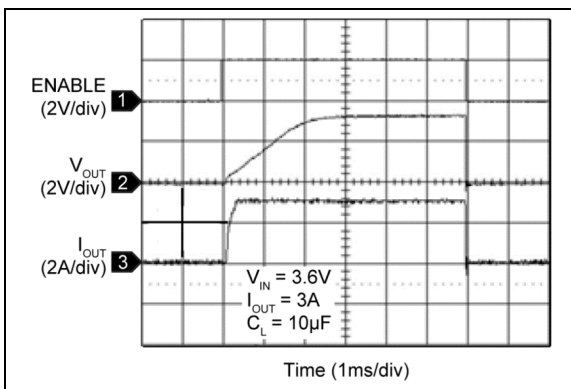

FIGURE 2-20: MIC94161/4/5 Start-Up ($I_{OUT} = 3A$).

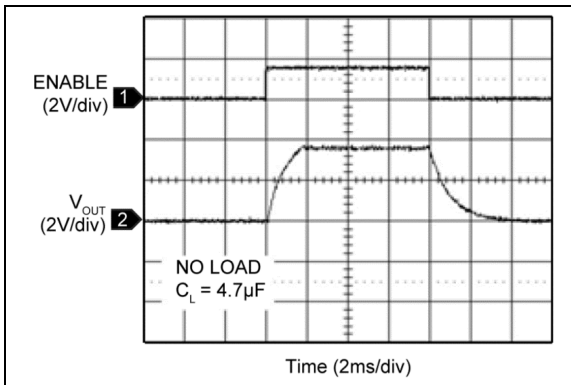

FIGURE 2-21: MIC94164 Auto Discharge.

MIC94161/2/3/4/5

3.0 PIN DESCRIPTIONS

The descriptions of the pins are listed in [Table 3-1](#).

TABLE 3-1: PIN FUNCTION TABLE

Pin Number	Pin Name	Description
A1, B1	VOUT	Source of N-channel MOSFET.
C1	GND	Ground.
A2, B2	VIN	Input Supply: Drain of N-channel MOSFET.
C2	EN	Enable (Input): Active-high control input for switch. Internal 2 M Ω pull-down resistor. Output will be off if this pin is left floating.

4.0 FUNCTIONAL DESCRIPTION

The MIC94161/2/3/4/5 is a family of high-side load switches designed to operate from 1.7V to 5.5V input voltage. The load switch pass element is an internal 14.5 mΩ R_{DS(ON)} N-Channel MOSFET that enables the device to support up to 3A of continuous current. Additionally, the load switch supports 1.5V logic level control and shutdown features in a tiny 1.5 mm × 1 mm 6-ball WLCSP package.

The MIC9416x provides reverse current protection when the device is disabled. The device will not allow the flow of current from the output to the input when the device is turned OFF. Additionally, the MIC94161 features overvoltage protection to protect the load when the input voltage is above 4.55V, as well as a precise enable threshold that keeps the MIC94161 in the default OFF state until the EN pin rises above 1.15V.

The MIC94162/3 features rapid turn on for applications that require a quick startup time. The MIC94161/4/5 provides a slew rate controlled soft-start turn-on of 2.7 ms. The soft-start feature is provided to prevent an in-rush current event from pulling down the input supply voltage.

The MIC94162/4 feature an active load discharge circuit that switches in a 200Ω load when the switch is disabled to automatically discharge a capacitive load.

An active pull-down on the enable input keeps the MIC94161/2/3/4/5 in a default OFF state until the enable pin is pulled above 1.2V. Internal level shift circuitry allows low voltage logic signals to switch higher supply voltages. The enable voltage can be as high as 5.5V and is not limited by the input voltage.

4.1 Power Switch SOA

The safe operating area (SOA) curve represents the boundary of maximum safe operating current and maximum safe operating junction temperature.

Figure 4-1 illustrates the SOA for various input voltages, with the package mounted on a typical 1 layer, 1 square inch copper board.

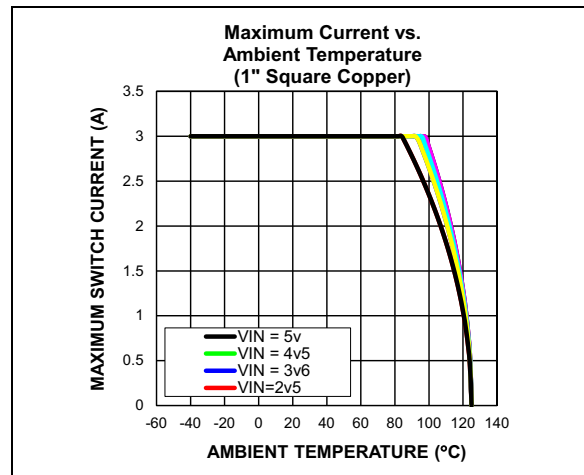

FIGURE 4-1: Safe Operating Area (SOA) Graph.

4.2 Power Dissipation Considerations

As with all power switches, the current rating of the switch is limited mostly by the thermal properties of the package and the PCB it is mounted on. There is a simple ohms law type relationship between thermal resistance, power dissipation and temperature, which are analogous to an electrical circuit:

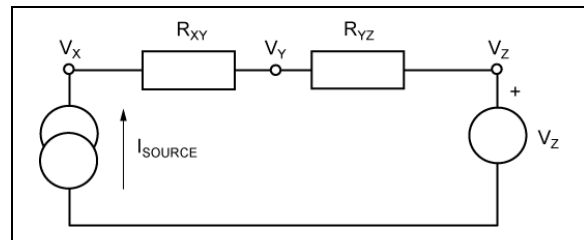

FIGURE 4-2: Simple Electrical Circuit.

From this simple circuit we can calculate V_X if we know I_{SOURCE} , V_Z and the resistor values R_{XY} and R_{YZ} using Equation 4-1:

EQUATION 4-1:

$$V_X = I_{SOURCE} \times (R_{XY} + R_{YZ}) + V_Z$$

Thermal circuits can be considered using these same rules and can be drawn similarly by replacing current sources with power dissipation (in watts), resistance with thermal resistance (in °C/W) and voltage sources with temperature (in °C).

MIC94161/2/3/4/5

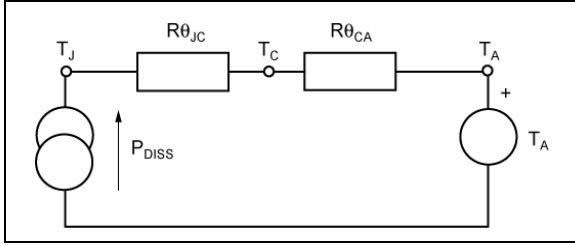

FIGURE 4-3: Simple Thermal Circuit.

Replacing the variables in the equation for V_X , one can find the junction temperature (T_J) from power dissipation, ambient temperature, and the known thermal resistance of the PCB ($R_{\theta_{CA}}$) and the package ($R_{\theta_{JC}}$).

P_{DISS} is calculated as $I_{SW}^2 \times R_{SW(MAX)}$. $R_{\theta_{JC}}$ is found in the operating ratings section of the data sheet and $R_{\theta_{CA}}$ (the PCB thermal resistance) values for various PCB copper areas is discussed in the document Designing with Low Dropout Voltage Regulators.

Example:

A switch is intended to drive a 3A load and is placed on a printed circuit board which has a ground plane area of at least 25 mm × 25 mm (625 mm²). The voltage source is a Li-ion battery with a lower operating threshold of 3V and the ambient temperature of the assembly can be up to 80°C.

Summary of variables:

- $I_{SW} = 3A$
- $V_{IN} = 3V$ to 4.2V
- $T_A = 80^\circ C$
- $R_{\theta_{JA}} = 108^\circ C/W$
- $P_{DISS} = I_{SW}^2 \times R_{SW}$

The worst case switch resistance (R_{SW}) at the lowest V_{IN} of 3V is not available in the data sheet, so the next lower value of V_{IN} is used, as shown in Equation 4-2:

EQUATION 4-2:

$$R_{SW@2.7V} = 21 m\Omega$$

If this were a figure for worst case R_{SW} for 25°C, an additional consideration is to allow for the maximum junction temperature of 125°C, in this case can be 30% higher Figure 2-1:

EQUATION 4-3:

$$R_{SW(MAX)} = 27 m\Omega$$

Therefore:

$$T_{RISE} = ((3A)^2 \times 27m\Omega) \times 108^\circ C/W = 26.2^\circ C$$

$$T_J = T_{RISE} + T_A = 26.2^\circ C + 80^\circ C = 106.2^\circ C$$

This is below the maximum of 125°C.

5.0 PACKAGING INFORMATION

5.1 Package Marking Information

6-Ball WLCSP*

XX NNN

Example

1Q 846

Note: The two-character code in the first line of the package marking is different for each device. MIC94161 (1Q), MIC94162 (2Q), MIC94163 (3Q), MIC94164 (4Q), and MIC94165 (ZQ).

<p>Legend: XX...X Product code or customer-specific information Y Year code (last digit of calendar year) YY Year code (last 2 digits of calendar year) WW Week code (week of January 1 is week '01') NNN Alphanumeric traceability code (e3) Pb-free JEDEC® designator for Matte Tin (Sn) * This package is Pb-free. The Pb-free JEDEC designator ((e3)) can be found on the outer packaging for this package.</p> <p>•, ▲, ▼ Pin one index is identified by a dot, delta up, or delta down (triangle mark).</p>
--

<p>Note: In the event the full Microchip part number cannot be marked on one line, it will be carried over to the next line, thus limiting the number of available characters for customer-specific information. Package may or may not include the corporate logo.</p> <p>Underbar (_) and/or Overbar (¯) symbol may not be to scale.</p>

MIC94161/2/3/4/5

6-Ball WLCSP Package Outline and Recommended Land Pattern

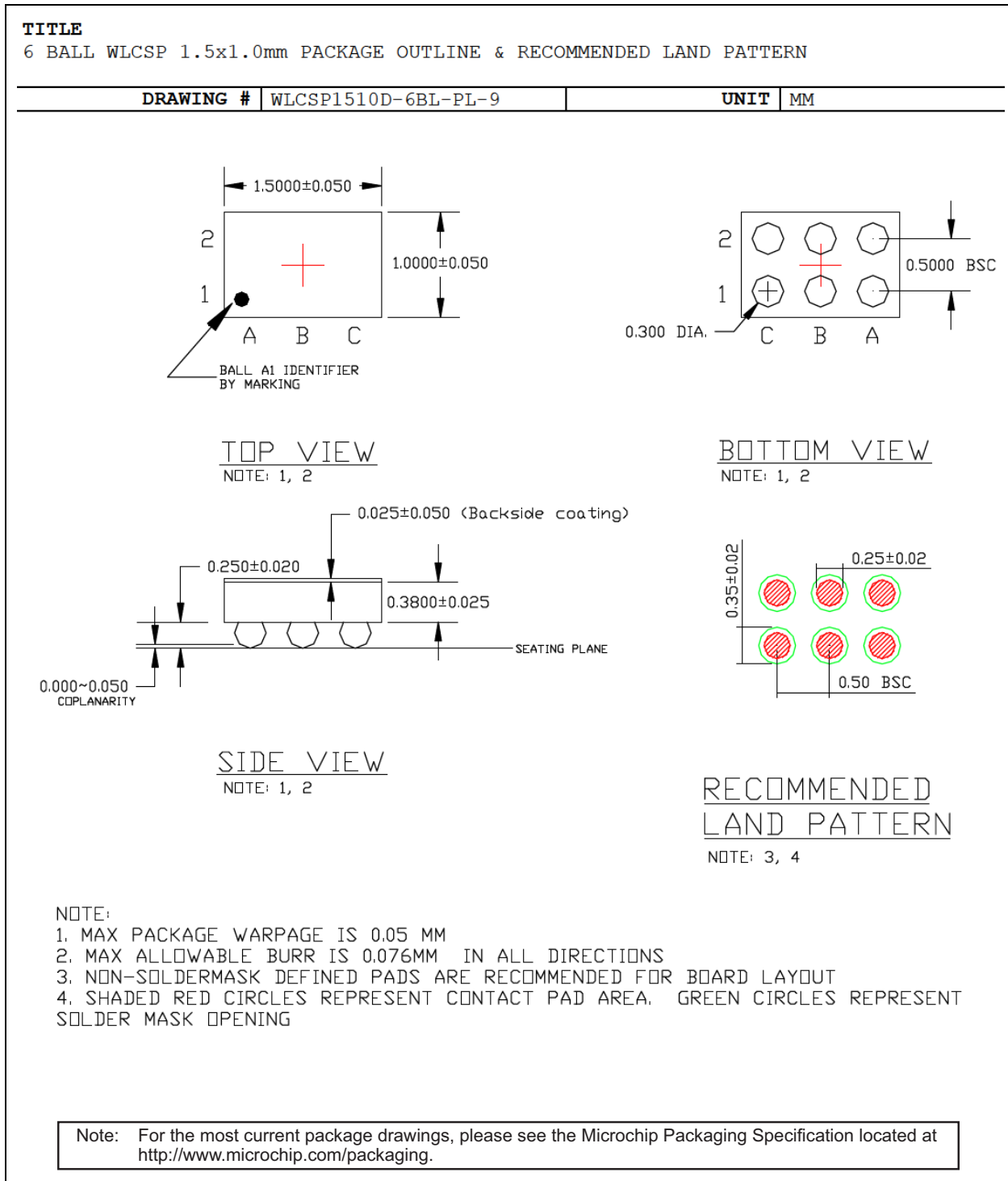

APPENDIX A: REVISION HISTORY

Revision A (October 2020)

- Converted Micrel document MIC94161/2/3/4/5 to Microchip data sheet template DS20006439A.
- Minor grammatical text changes throughout.

MIC94161/2/3/4/5

NOTES:

PRODUCT IDENTIFICATION SYSTEM

To order or obtain information, e.g., on pricing or delivery, contact your local Microchip representative or sales office.

<u>Device</u>	<u>X</u>	<u>XX</u>	<u>-XX</u>	Examples:
Part No.	Temperature Range	Package	Media Type	
Device:	MIC94161:	3A High-Side Load Switch with Reverse Blocking, OVP, and Soft-Start		a) MIC94161YCS-TR: MIC94161, -40°C to +125°C, 6-Ball WLCSP, 3,000/Reel
	MIC94162:	3A High-Side Load Switch with Reverse Blocking, Ultra-Fast Turn-On, and Auto-Discharge		b) MIC94162YCS-TR: MIC94162, -40°C to +125°C, 6-Ball WLCSP, 3,000/Reel
	MIC94163:	3A High-Side Load Switch with Reverse Blocking and Ultra-Fast Turn-On		c) MIC94163YCS-TR: MIC94163, -40°C to +125°C, 6-Ball WLCSP, 3,000/Reel
	MIC94164:	3A High-Side Load Switch with Reverse Blocking, Soft-Start, and Auto-Discharge		d) MIC94164YCS-TR: MIC94164, -40°C to +125°C, 6-Ball WLCSP, 3,000/Reel
	MIC94165:	3A High-Side Load Switch with Reverse Blocking and Soft-Start		e) MIC94165YCS-TR: MIC94165, -40°C to +125°C, 6-Ball WLCSP, 3,000/Reel
Temperature Range:	Y =	-40°C to +125°C		Note 1: Tape and Reel identifier only appears in the catalog part number description. This identifier is used for ordering purposes and is not printed on the device package. Check with your Microchip Sales Office for package availability with the Tape and Reel option.
Package:	CS =	6-Ball 1.5 mm x 1.0 mm WLCSP		
Media Type:	TR =	3,000/Reel		

MIC94161/2/3/4/5

NOTES:

Note the following details of the code protection feature on Microchip devices:

- Microchip products meet the specifications contained in their particular Microchip Data Sheet.
- Microchip believes that its family of products is secure when used in the intended manner and under normal conditions.
- There are dishonest and possibly illegal methods being used in attempts to breach the code protection features of the Microchip devices. We believe that these methods require using the Microchip products in a manner outside the operating specifications contained in Microchip's Data Sheets. Attempts to breach these code protection features, most likely, cannot be accomplished without violating Microchip's intellectual property rights.
- Microchip is willing to work with any customer who is concerned about the integrity of its code.
- Neither Microchip nor any other semiconductor manufacturer can guarantee the security of its code. Code protection does not mean that we are guaranteeing the product is "unbreakable." Code protection is constantly evolving. We at Microchip are committed to continuously improving the code protection features of our products. Attempts to break Microchip's code protection feature may be a violation of the Digital Millennium Copyright Act. If such acts allow unauthorized access to your software or other copyrighted work, you may have a right to sue for relief under that Act.

Information contained in this publication is provided for the sole purpose of designing with and using Microchip products. Information regarding device applications and the like is provided only for your convenience and may be superseded by updates. It is your responsibility to ensure that your application meets with your specifications.

THIS INFORMATION IS PROVIDED BY MICROCHIP "AS IS". MICROCHIP MAKES NO REPRESENTATIONS OR WARRANTIES OF ANY KIND WHETHER EXPRESS OR IMPLIED, WRITTEN OR ORAL, STATUTORY OR OTHERWISE, RELATED TO THE INFORMATION INCLUDING BUT NOT LIMITED TO ANY IMPLIED WARRANTIES OF NON-INFRINGEMENT, MERCHANTABILITY, AND FITNESS FOR A PARTICULAR PURPOSE OR WARRANTIES RELATED TO ITS CONDITION, QUALITY, OR PERFORMANCE.

IN NO EVENT WILL MICROCHIP BE LIABLE FOR ANY INDIRECT, SPECIAL, PUNITIVE, INCIDENTAL OR CONSEQUENTIAL LOSS, DAMAGE, COST OR EXPENSE OF ANY KIND WHATSOEVER RELATED TO THE INFORMATION OR ITS USE, HOWEVER CAUSED, EVEN IF MICROCHIP HAS BEEN ADVISED OF THE POSSIBILITY OR THE DAMAGES ARE FORESEEABLE. TO THE FULLEST EXTENT ALLOWED BY LAW, MICROCHIP'S TOTAL LIABILITY ON ALL CLAIMS IN ANY WAY RELATED TO THE INFORMATION OR ITS USE WILL NOT EXCEED THE AMOUNT OF FEES, IF ANY, THAT YOU HAVE PAID DIRECTLY TO MICROCHIP FOR THE INFORMATION. Use of Microchip devices in life support and/or safety applications is entirely at the buyer's risk, and the buyer agrees to defend, indemnify and hold harmless Microchip from any and all damages, claims, suits, or expenses resulting from such use. No licenses are conveyed, implicitly or otherwise, under any Microchip intellectual property rights unless otherwise stated.

Trademarks

The Microchip name and logo, the Microchip logo, Adaptec, AnyRate, AVR, AVR logo, AVR Freaks, BesTime, BitCloud, chipKIT, chipKIT logo, CryptoMemory, CryptoRF, dsPIC, FlashFlex, flexPWR, HELDO, IGLOO, JukeBlox, KeeLoq, Kleer, LANCheck, LinkMD, maXStylus, maXTouch, MediaLB, megaAVR, Microsemi, Microsemi logo, MOST, MOST logo, MPLAB, OptoLyzer, PackeTime, PIC, picoPower, PICSTART, PIC32 logo, PolarFire, Prochip Designer, QTouch, SAM-BA, SenGenuity, SpyNIC, SST, SST Logo, SuperFlash, Symmetricom, SyncServer, Tachyon, TempTracker, TimeSource, tinyAVR, UNI/O, Vectron, and XMEGA are registered trademarks of Microchip Technology Incorporated in the U.S.A. and other countries.

APT, ClockWorks, The Embedded Control Solutions Company, EtherSynch, FlashTec, Hyper Speed Control, HyperLight Load, IntelliMOS, Libero, motorBench, mTouch, Powermite 3, Precision Edge, ProASIC, ProASIC Plus, ProASIC Plus logo, Quiet-Wire, SmartFusion, SyncWorld, Temux, TimeCesium, TimeHub, TimePictra, TimeProvider, Vite, WinPath, and ZL are registered trademarks of Microchip Technology Incorporated in the U.S.A.

Adjacent Key Suppression, AKS, Analog-for-the-Digital Age, Any Capacitor, AnyIn, AnyOut, BlueSky, BodyCom, CodeGuard, CryptoAuthentication, CryptoAutomotive, CryptoCompanion, CryptoController, dsPICDEM, dsPICDEM.net, Dynamic Average Matching, DAM, ECAN, EtherGREEN, In-Circuit Serial Programming, ICSP, INICnet, Inter-Chip Connectivity, JitterBlocker, KleerNet, KleerNet logo, memBrain, Minda, MiWi, MPASM, MPF, MPLAB Certified logo, MPLIB, MPLINK, MultiTRAK, NetDetach, Omniscient Code Generation, PICDEM, PICDEM.net, PICkit, PICtail, PowerSmart, PureSilicon, QMatrix, REAL ICE, Ripple Blocker, SAM-ICE, Serial Quad I/O, SMART-I.S., SQI, SuperSwitcher, SuperSwitcher II, Total Endurance, TSHARC, USBCheck, VariSense, ViewSpan, WiperLock, Wireless DNA, and ZENA are trademarks of Microchip Technology Incorporated in the U.S.A. and other countries.

SQTP is a service mark of Microchip Technology Incorporated in the U.S.A.

The Adaptec logo, Frequency on Demand, Silicon Storage Technology, and Symmcom are registered trademarks of Microchip Technology Inc. in other countries.

GestIC is a registered trademark of Microchip Technology Germany II GmbH & Co. KG, a subsidiary of Microchip Technology Inc., in other countries.

All other trademarks mentioned herein are property of their respective companies.

© 2020, Microchip Technology Incorporated, All Rights Reserved.

ISBN: 978-1-5224-6907-0

For information regarding Microchip's Quality Management Systems, please visit www.microchip.com/quality.



MICROCHIP

Worldwide Sales and Service

AMERICAS

Corporate Office
2355 West Chandler Blvd.
Chandler, AZ 85224-6199
Tel: 480-792-7200
Fax: 480-792-7277
Technical Support:
<http://www.microchip.com/support>
Web Address:
www.microchip.com

Atlanta

Duluth, GA
Tel: 678-957-9614
Fax: 678-957-1455

Austin, TX

Tel: 512-257-3370

Boston

Westborough, MA
Tel: 774-760-0087
Fax: 774-760-0088

Chicago

Itasca, IL
Tel: 630-285-0071
Fax: 630-285-0075

Dallas

Addison, TX
Tel: 972-818-7423
Fax: 972-818-2924

Detroit

Novi, MI
Tel: 248-848-4000

Houston, TX

Tel: 281-894-5983

Indianapolis

Noblesville, IN
Tel: 317-773-8323
Fax: 317-773-5453
Tel: 317-536-2380

Los Angeles

Mission Viejo, CA
Tel: 949-462-9523
Fax: 949-462-9608
Tel: 951-273-7800

Raleigh, NC

Tel: 919-844-7510

New York, NY

Tel: 631-435-6000

San Jose, CA

Tel: 408-735-9110
Tel: 408-436-4270

Canada - Toronto

Tel: 905-695-1980
Fax: 905-695-2078

ASIA/PACIFIC

Australia - Sydney
Tel: 61-2-9868-6733

China - Beijing
Tel: 86-10-8569-7000

China - Chengdu
Tel: 86-28-8665-5511

China - Chongqing
Tel: 86-23-8980-9588

China - Dongguan
Tel: 86-769-8702-9880

China - Guangzhou
Tel: 86-20-8755-8029

China - Hangzhou
Tel: 86-571-8792-8115

China - Hong Kong SAR
Tel: 852-2943-5100

China - Nanjing
Tel: 86-25-8473-2460

China - Qingdao
Tel: 86-532-8502-7355

China - Shanghai
Tel: 86-21-3326-8000

China - Shenyang
Tel: 86-24-2334-2829

China - Shenzhen
Tel: 86-755-8864-2200

China - Suzhou
Tel: 86-186-6233-1526

China - Wuhan
Tel: 86-27-5980-5300

China - Xian
Tel: 86-29-8833-7252

China - Xiamen
Tel: 86-592-2388138

China - Zhuhai
Tel: 86-756-3210040

ASIA/PACIFIC

India - Bangalore
Tel: 91-80-3090-4444

India - New Delhi
Tel: 91-11-4160-8631

India - Pune
Tel: 91-20-4121-0141

Japan - Osaka
Tel: 81-6-6152-7160

Japan - Tokyo
Tel: 81-3-6880-3770

Korea - Daegu
Tel: 82-53-744-4301

Korea - Seoul
Tel: 82-2-554-7200

Malaysia - Kuala Lumpur
Tel: 60-3-7651-7906

Malaysia - Penang
Tel: 60-4-227-8870

Philippines - Manila
Tel: 63-2-634-9065

Singapore
Tel: 65-6334-8870

Taiwan - Hsin Chu
Tel: 886-3-577-8366

Taiwan - Kaohsiung
Tel: 886-7-213-7830

Taiwan - Taipei
Tel: 886-2-2508-8600

Thailand - Bangkok
Tel: 66-2-694-1351

Vietnam - Ho Chi Minh
Tel: 84-28-5448-2100

EUROPE

Austria - Wels
Tel: 43-7242-2244-39
Fax: 43-7242-2244-393

Denmark - Copenhagen
Tel: 45-4485-5910
Fax: 45-4485-2829

Finland - Espoo
Tel: 358-9-4520-820

France - Paris
Tel: 33-1-69-53-63-20
Fax: 33-1-69-30-90-79

Germany - Garching
Tel: 49-8931-9700

Germany - Haan
Tel: 49-2129-3766400

Germany - Heilbronn
Tel: 49-7131-72400

Germany - Karlsruhe
Tel: 49-721-625370

Germany - Munich
Tel: 49-89-627-144-0
Fax: 49-89-627-144-44

Germany - Rosenheim
Tel: 49-8031-354-560

Israel - Ra'anana
Tel: 972-9-744-7705

Italy - Milan
Tel: 39-0331-742611
Fax: 39-0331-466781

Italy - Padova
Tel: 39-049-7625286

Netherlands - Drunen
Tel: 31-416-690399
Fax: 31-416-690340

Norway - Trondheim
Tel: 47-7288-4388

Poland - Warsaw
Tel: 48-22-3325737

Romania - Bucharest
Tel: 40-21-407-87-50

Spain - Madrid
Tel: 34-91-708-08-90
Fax: 34-91-708-08-91

Sweden - Gothenberg
Tel: 46-31-704-60-40

Sweden - Stockholm
Tel: 46-8-5090-4654

UK - Wokingham
Tel: 44-118-921-5800
Fax: 44-118-921-5820