

# T-1 PACKAGE PIN PHOTODIODE

## MID-30A12

### Description

The MID-30A12 is a PIN photodiode mounted in a lensed, special dark plastic package. The lensing effect of the package allows an acceptance half view angle of  $10^\circ$  that is measured from the optical axis to the half power point.

### Features

- High photo sensitivity
- Low junction capacitance
- High cut-off frequency
- Fast switching time
- Good spectral matching IRED ( $\lambda_p=940\text{nm}$ ) type.

### Package Dimensions

Unit : mm (inches)

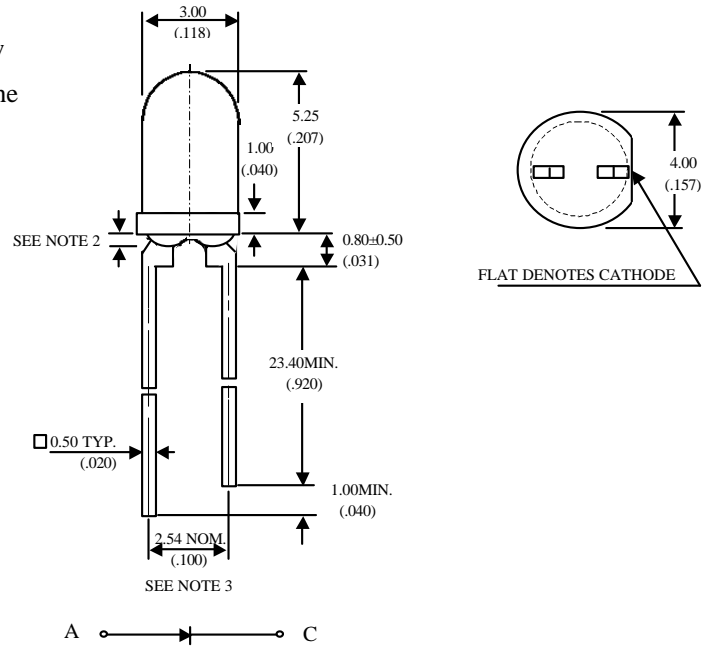

Notes :

1. Tolerance is  $\pm 0.25$  mm (.010") unless otherwise noted.
2. Protruded resin under flange is 0.8 mm (.031") max.
3. Lead spacing is measured where the leads emerge from the package.

### Absolute Maximum Ratings

@  $T_A=25^\circ\text{C}$

Parameter	Maximum Rating	Unit
Power Dissipation	100	mW
Reverse Break Down Voltage	30	V
Operating Temperature Range	-55°C to +100°C	
Storage Temperature Range	-55°C to +100°C	
Lead Soldering Temperature	260°C for 5 seconds	

**UNI**

Unity Opto Technology Co., Ltd.

02/04/2002

## Optical-Electrical Characteristics

@ T<sub>A</sub>=25°C

Parameter	Test Conditions	Symbol	Min.	Typ.	Max.	Unit
Reverse Break Down Voltage	I <sub>R</sub> =100μA E <sub>e</sub> =0	V <sub>(BR)R</sub>	30			V
Reverse Dark Current	V <sub>R</sub> =10V E <sub>e</sub> =0	I <sub>D</sub>			30	nA
Open Circuit Voltage	λ=940nm E <sub>e</sub> =0.1mW/cm <sup>2</sup>	V <sub>OC</sub>		350		mV
Rise Time	V <sub>R</sub> =10V λ=940nm	Tr		40		nsec
Fall Time	R <sub>L</sub> =1KΩ	Tf		30		
Light Current	V <sub>R</sub> =5V, λ=940nm E <sub>e</sub> =0.1mW/cm <sup>2</sup>	I <sub>L</sub>	1	4		μA
Total Capacitance	V <sub>R</sub> =3V, f=1MHZ E <sub>e</sub> =0	C <sub>T</sub>		15		pF
Half Acceptance Angle	V <sub>R</sub> =5V E <sub>e</sub> =0.1mW/cm <sup>2</sup>	2θ <sub>1/2</sub>		25		deg.

## Typical Optical-Electrical Characteristic Curves

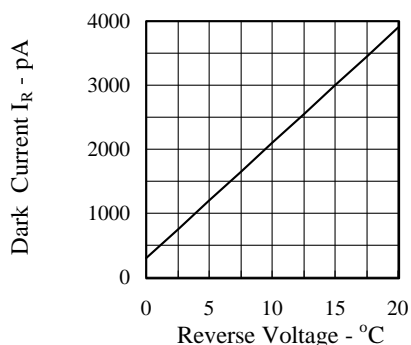

FIG.1 DARK CURRENT VS REVERSE VOLTAGE  
T<sub>AMB</sub>=25°C, E<sub>e</sub>=0 mW/cm<sup>2</sup>

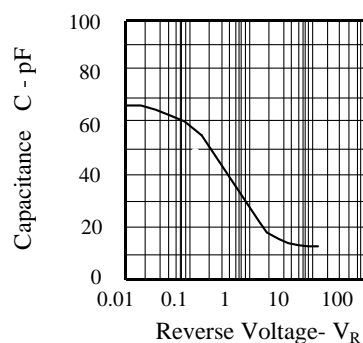

FIG.2 CAPACITANCE VS. REVERSE VOLTAGE  
F=1MHZ ; E<sub>e</sub>=0mW/cm<sup>2</sup>

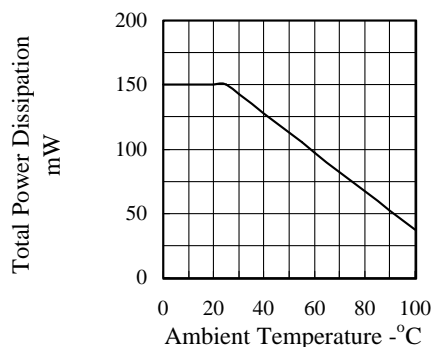

FIG.3 TOTAL POWER DISSIPATION VS. AMBIENT TEMPERATURE

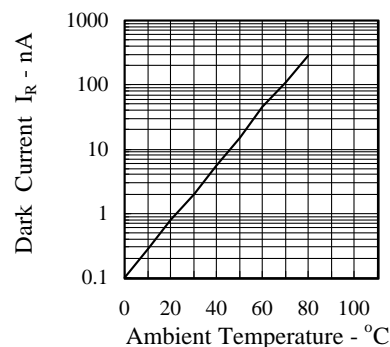

FIG.4 DARK CURRENT VS AMBIENT TEMPERATURE  
V<sub>R</sub>=10, E<sub>e</sub>=0 mw/cm<sup>2</sup>

Typical Optical-Electrical Characteristic Curves

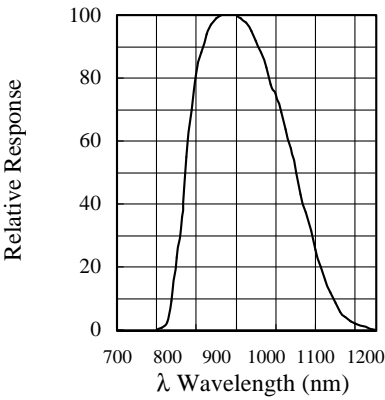

FIG.5 RELATIVE SPECTRAL SENSITIVITY VS. WAVELENGTH

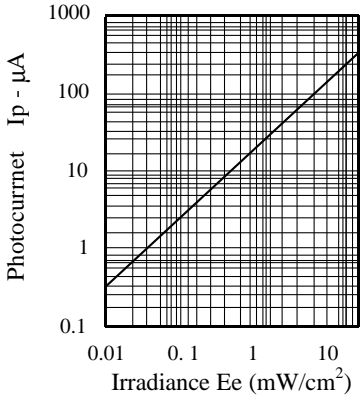

FIG.6 PHOTOCURRENT VS. IRRADIANCE = 950 nm

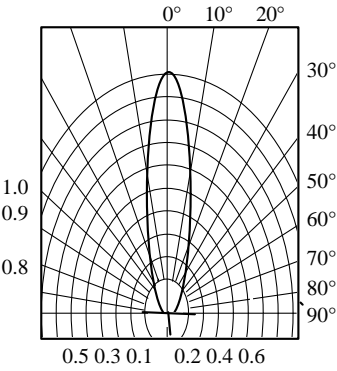

FIG.7 SENSITIVITY DIAGRAM