

T-1 PACKAGE NPN PHOTOTRANSISTOR

MID-33422

Description

The MID-33422 is a NPN silicon phototransistor mounted in a lensed, water clear plastic package and suitable for the variety wavelength.

Features

- Wide range of collector current
- Lensed for high sensitivity
- Low cost plastic package
- Suitable for the variety wavelength
- Acceptance view angle : 30°

Package Dimensions

Unit: mm (inches)

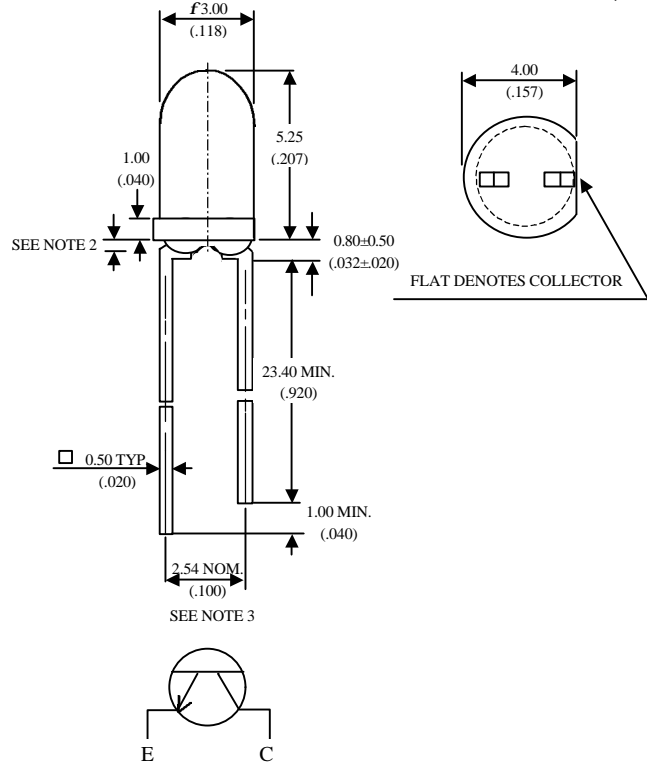

Notes :

1. Tolerance is ± 0.25 mm (.010") unless otherwise noted .
2. Protruded resin under flange is 0.5 mm (.019") max
3. Lead spacing is measured where the leads emerge from the package.

Absolute Maximum Ratings

@ T_A=25°C

Parameter	Maximum Rating	Unit
Power Dissipation	100	mW
Collector-Emitter Voltage	30	V
Emitter-Collector Voltage	5	V
Operating Temperature Range	-55°C to +100°C	
Storage Temperature Range	-55°C to +100°C	
Lead Soldering Temperature	260°C for 5 seconds	

UNI

Unity Opto Technology Co., Ltd.

02/04/2002

Optical-Electrical Characteristics

@ T_A=25°C

Parameter	Test Conditions	Symbol	Min.	Typ .	Max.	Unit
Collector-Emitter Breakdown Voltage	I _c =0.1mA Ee=0	V _{(BR)CEO}	30			V
Emitter-Collector Breakdown Voltage	I _e =0.1mA Ee=0	V _{(BR)ECO}	5			V
Collector-Emitter Saturation Voltage	I _c =0.5mA Ee=0.1mW/cm ²	V _{CE(SAT)}			0.4	V
Rise Time	V _{CC} =5V, R _L =1KΩ	Tr		15		μS
Fall Time	I _c =1mA	Tf		15		
Collector Dark Current	V _{CE} =10V Ee=0	I _{CEO}			100	nA
On State Collector Current	V _{CE} =5V Ee=0.1mW/cm ²	I _{C(ON)}		2.4		mA

Typical Optical-Electrical Characteristic Curves

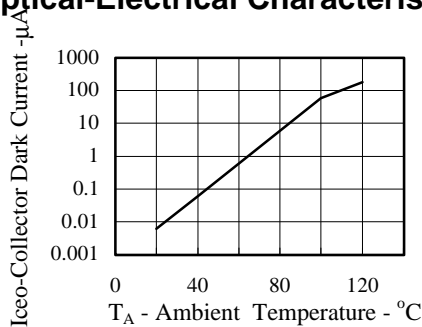

FIG.1 COLLECTOR DARK CURRENT VS AMBIENT TEMPERATURE

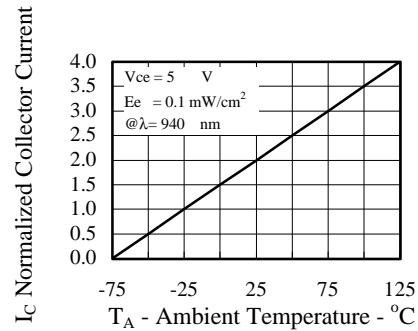

FIG.2 NORMALIZED COLLECTOR CURRENT

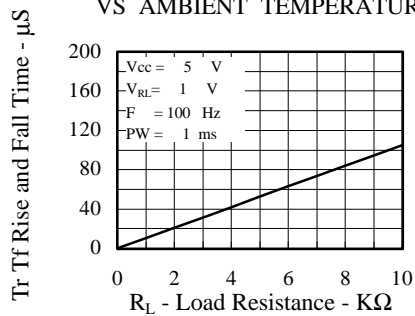

FIG.3 RISE AND FALL TIME VS LOAD RESISTANCE

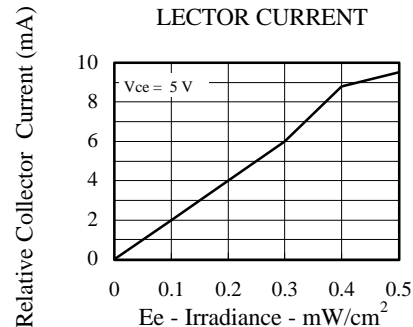

FIG.4 RELATIVE COLLECTOR CURRENT VS IRRADIANCE

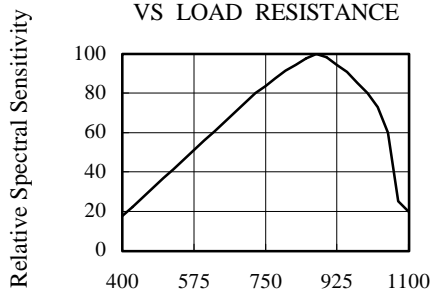

FIG.5 RELATIVE SPECTRAL SENSITIVITY S_{REL}=f(λ)

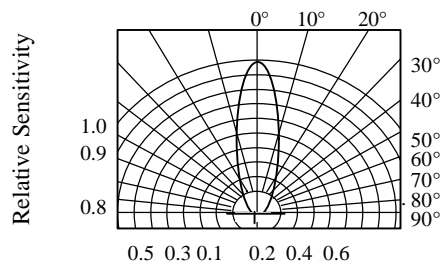

FIG.6 SENSITIVITY DIAGRAM