

**RADIATION HARDENED
 POWER MOSFET
 THRU-HOLE (TO-254AA)**

**IRHM7460SE
 JANSR2N7392 500V
 N-CHANNEL
 REF: MIL-PRF-19500/661
 RAD Hard™ HEXFET® TECHNOLOGY**

Product Summary

Part Number	Radiation Level	RDS(on)	ID	QPL Part Number
IRHM7460SE	100K Rads (Si)	0.32Ω	18A	JANSR2N7392



www.DataSheet4U.com

International Rectifier's RADHard™ HEXFET® MOSFET technology provides high performance power MOSFETs for space applications. This technology has over a decade of proven performance and reliability in satellite applications. These devices have been characterized for both Total Dose and Single Event Effects (SEE). The combination of low RDS(on) and low gate charge reduces the power losses in switching applications such as DC to DC converters and motor control. These devices retain all of the well established advantages of MOSFETs such as voltage control, fast switching, ease of paralleling and temperature stability of electrical parameters.

Features:

- Single Event Effect (SEE) Hardened
- Ultra Low RDS(on)
- Low Total Gate Charge
- Proton Tolerant
- Simple Drive Requirements
- Ease of Paralleling
- Hermetically Sealed
- Light Weight

Absolute Maximum Ratings

Pre-Irradiation

	Parameter		Units
ID @ VGS = 12V, TC = 25°C	Continuous Drain Current	18	A
ID @ VGS = 12V, TC = 100°C	Continuous Drain Current	11.7	
IDM	Pulsed Drain Current ①	72	
PD @ TC = 25°C	Max. Power Dissipation	250	W
	Linear Derating Factor	2.0	W/°C
VGS	Gate-to-Source Voltage	±20	V
EAS	Single Pulse Avalanche Energy ②	500	mJ
IAR	Avalanche Current ①	18	A
EAR	Repetitive Avalanche Energy ①	25	mJ
dv/dt	Peak Diode Recovery dv/dt ③	3.8	V/ns
TJ	Operating Junction	-55 to 150	°C
TSTG	Storage Temperature Range		
	Lead Temperature	300 (0.063 in. (1.6mm) from case for 10 sec.)	
	Weight	9.3 (Typical)	g

For footnotes refer to the last page

Electrical Characteristics @ T_j = 25°C (Unless Otherwise Specified)

Parameter		Min	Typ	Max	Units	Test Conditions
BVDSS	Drain-to-Source Breakdown Voltage	500	—	—	V	V _{GS} = 0V, I _D = 1.0mA
ΔBVDSS/ΔT _J	Temperature Coefficient of Breakdown Voltage	—	0.66	—	V/°C	Reference to 25°C, I _D = 1.0mA
RDS(on)	Static Drain-to-Source On-State Resistance	—	—	0.32	Ω	V _{GS} = 12V, I _D = 11.7A ④
		—	—	0.36		V _{GS} = 12V, I _D = 18A
VGS(th)	Gate Threshold Voltage	2.5	—	4.5	V	V _{DS} = V _{GS} , I _D = 1.0mA
gfs	Forward Transconductance	6.0	—	—	S (τ)	V _{DS} > 15V, I _{DS} = 11.7A ④
IDSS	Zero Gate Voltage Drain Current	—	—	50	μA	V _{DS} = 400V, V _{GS} = 0V
		—	—	250		V _{DS} = 400V, V _{GS} = 0V, T _J = 125°C
IGSS	Gate-to-Source Leakage Forward	—	—	100	nA	V _{GS} = 20V
IGSS	Gate-to-Source Leakage Reverse	—	—	-100		V _{GS} = -20V
Qg	Total Gate Charge	—	—	180	nC	V _{GS} = 12V, I _D = 18A V _{DS} = 250V
Qgs	Gate-to-Source Charge	—	—	30		
Qgd	Gate-to-Drain ('Miller') Charge	—	—	95		
td(on)	Turn-On Delay Time	—	—	29	ns	V _{DD} = 250V, I _D = 18A, V _{GS} = 12V, R _G = 2.35Ω
tr	Rise Time	—	—	93		
td(off)	Turn-Off Delay Time	—	—	90		
tf	Fall Time	—	—	59		
LS + LD	Total Inductance	—	6.8	—	nH	Measured from drain lead (6mm/0.25in. from package) to source lead (6mm/0.25in. from package)
Ciss	Input Capacitance	—	3500	—	pF	V _{GS} = 0V, V _{DS} = 25V f = 1.0MHz
Coss	Output Capacitance	—	730	—		
Crss	Reverse Transfer Capacitance	—	260	—		

Source-Drain Diode Ratings and Characteristics

Parameter		Min	Typ	Max	Units	Test Conditions
IS	Continuous Source Current (Body Diode)	—	—	18	A	
ISM	Pulse Source Current (Body Diode) ①	—	—	72		
VSD	Diode Forward Voltage	—	—	1.8	V	T _J = 25°C, I _S = 18A, V _{GS} = 0V ④
t _{rr}	Reverse Recovery Time	—	—	800	nS	T _J = 25°C, I _F = 18A, di/dt ≤ 100A/μs
QRR	Reverse Recovery Charge	—	—	16	μC	V _{DD} ≤ 50V ④
ton	Forward Turn-On Time	Intrinsic turn-on time is negligible. Turn-on speed is substantially controlled by LS + LD.				

Thermal Resistance

Parameter		Min	Typ	Max	Units	Test Conditions
R _{thJC}	Junction-to-Case	—	—	0.50	°C/W	Typical socket mount
R _{thCS}	Case-to-Sink	—	0.21	—		
R _{thJA}	Junction-to-Ambient	—	—	48		

Note: Corresponding Spice and Saber models are available on the G&S Website.

For footnotes refer to the last page

International Rectifier Radiation Hardened MOSFETs are tested to verify their radiation hardness capability. The hardness assurance program at International Rectifier is comprised of two radiation environments. Every manufacturing lot is tested for total ionizing dose (per notes 5 and 6) using the TO-3 package. Both pre- and post-irradiation performance are tested and specified using the same drive circuitry and test conditions in order to provide a direct comparison.

Table 1. Electrical Characteristics @ Tj = 25°C, Post Total Dose Irradiation ⑤⑥

	Parameter	100K Rads (Si)		Units	Test Conditions ⑧
		Min	Max		
BV _{DSS}	Drain-to-Source Breakdown Voltage	500	—	V	V _{GS} = 0V, I _D = 1.0mA
V _{GS(th)}	Gate Threshold Voltage	2.0	4.5		V _{GS} = V _{DS} , I _D = 1.0mA
I _{GSS}	Gate-to-Source Leakage Forward	—	100	nA	V _{GS} = 20V
I _{GSS}	Gate-to-Source Leakage Reverse	—	-100		V _{GS} = -20V
I _{DSS}	Zero Gate Voltage Drain Current	—	50	μA	V _{DS} = 400V, V _{GS} = 0V
R _{DS(on)}	Static Drain-to-Source ④ On-State Resistance (TO-3)	—	0.32	Ω	V _{GS} = 12V, I _D = 11.7A
R _{DS(on)}	Static Drain-to-Source ④ On-State Resistance (TO-254)	—	0.32	Ω	V _{GS} = 12V, I _D = 11.7A
V _{SD}	Diode Forward Voltage ④	—	1.8	V	V _{GS} = 0V, I _D = 18A

International Rectifier radiation hardened MOSFETs have been characterized in heavy ion environment for Single Event Effects (SEE). Single Event Effects characterization is illustrated in Fig. a and Table 2.

Table 2. Single Event Effect Safe Operating Area

Ion	LET MeV/(mg/cm ²)	Energy (MeV)	Range (μm)	V _{DS} (V)				
				@V _{GS} =0V	@V _{GS} =-5V	@V _{GS} =-10V	@V _{GS} =-15V	@V _{GS} =-20V
Cu	28	285	43	375	375	375	375	375
Br	36.8	305	39	350	350	350	325	300
Ni	26.6	265	42	—	375	—	—	—

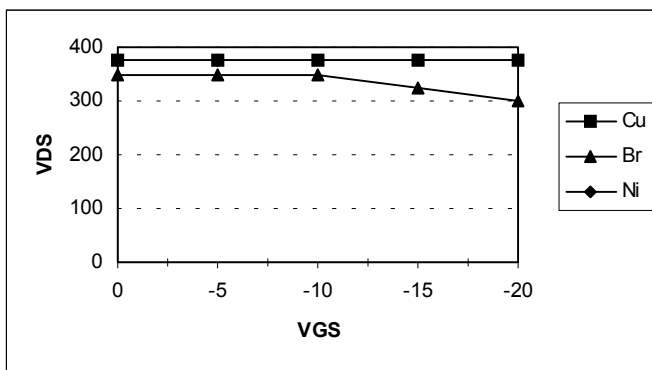

Fig a. Single Event Effect, Safe Operating Area

For footnotes refer to the last page

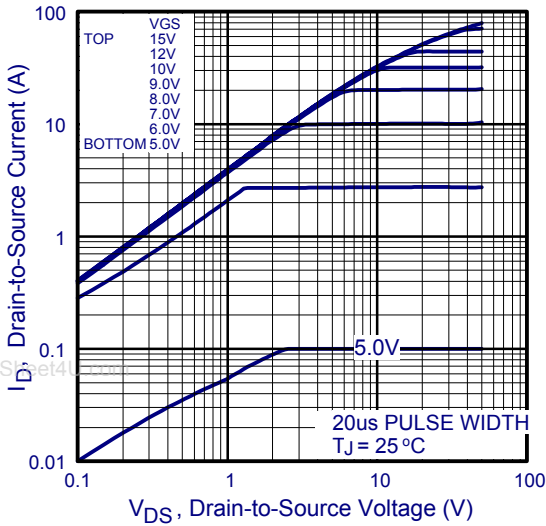

Fig 1. Typical Output Characteristics

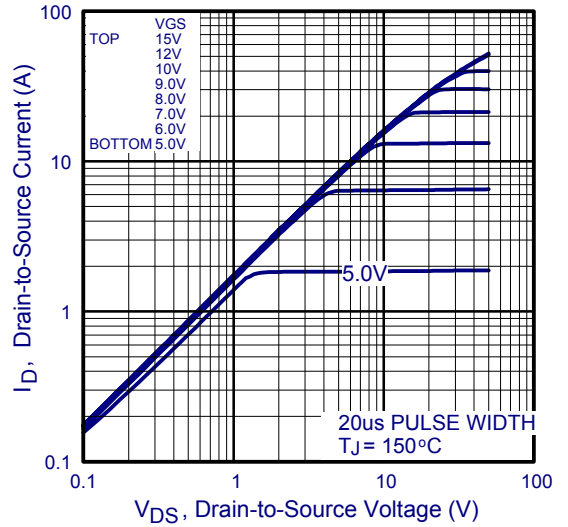

Fig 2. Typical Output Characteristics

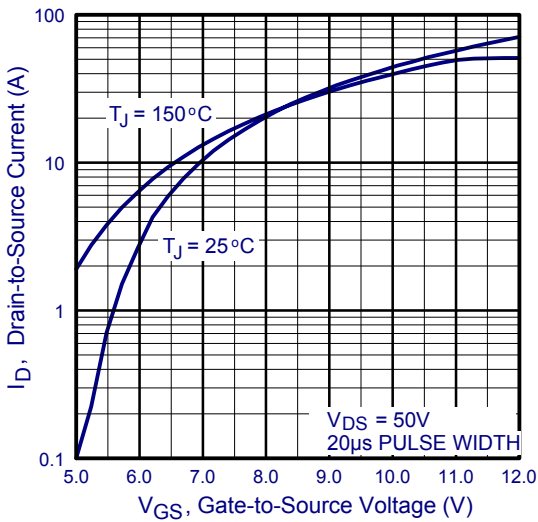

Fig 3. Typical Transfer Characteristics

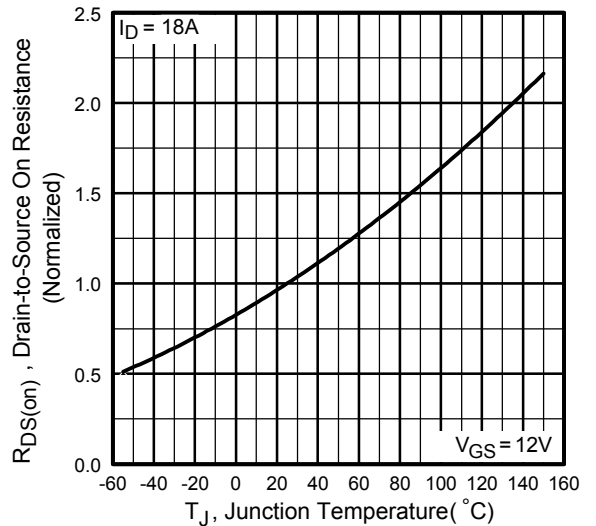

Fig 4. Normalized On-Resistance

Vs. Temperature

www.DataSheet4U.com

www.irf.com

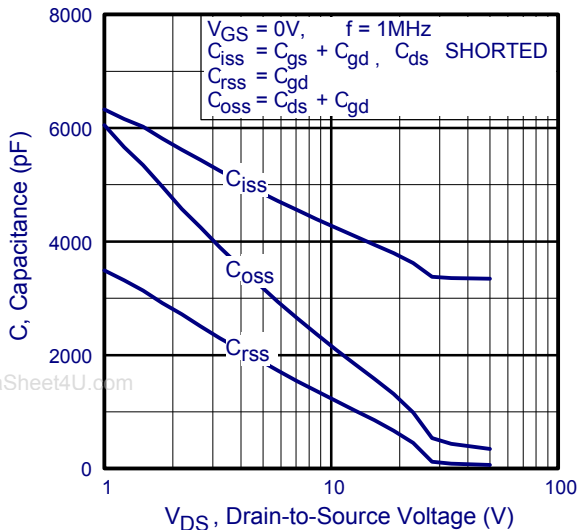

Fig 5. Typical Capacitance Vs. Drain-to-Source Voltage

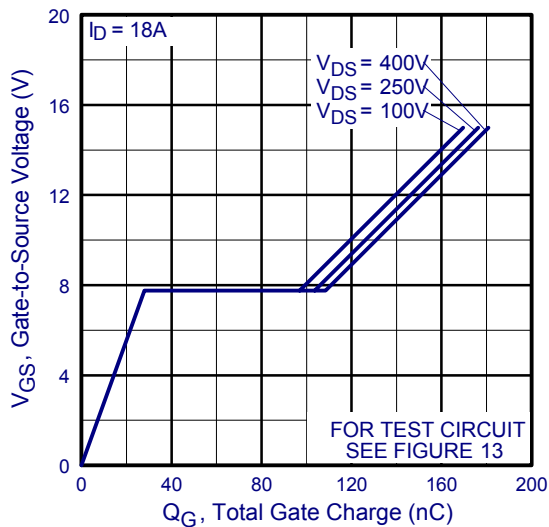

Fig 6. Typical Gate Charge Vs. Gate-to-Source Voltage

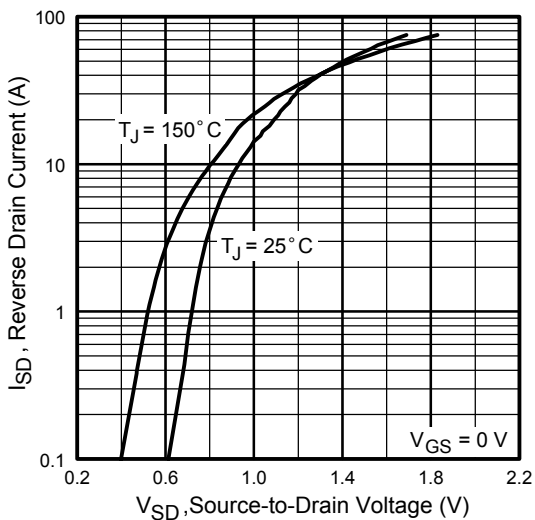

Fig 7. Typical Source-Drain Diode Forward Voltage

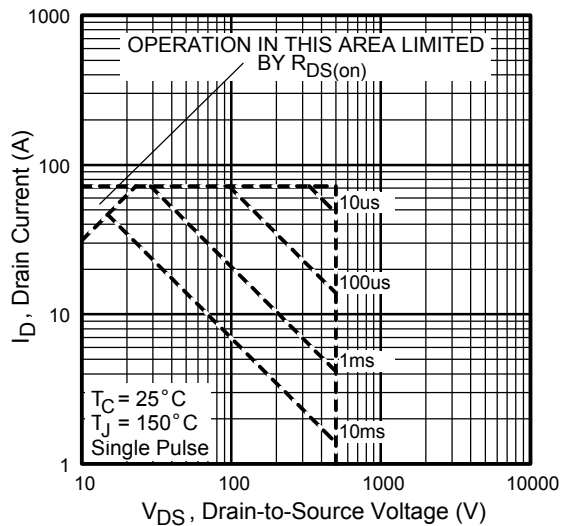

Fig 8. Maximum Safe Operating Area

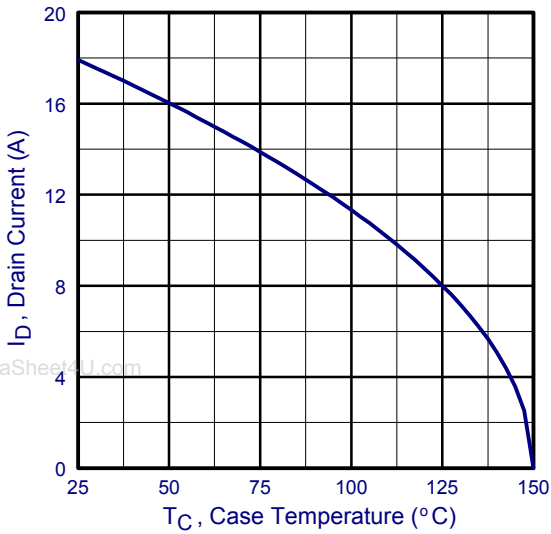

Fig 9. Maximum Drain Current Vs. Case Temperature

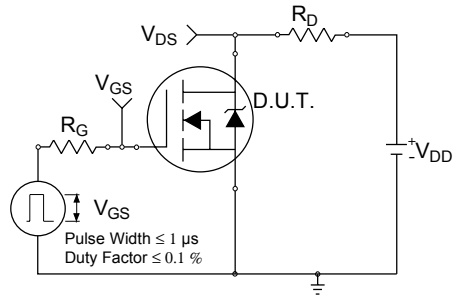

Fig 10a. Switching Time Test Circuit

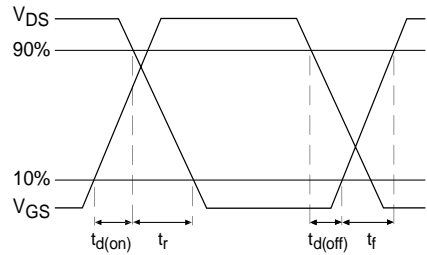

Fig 10b. Switching Time Waveforms

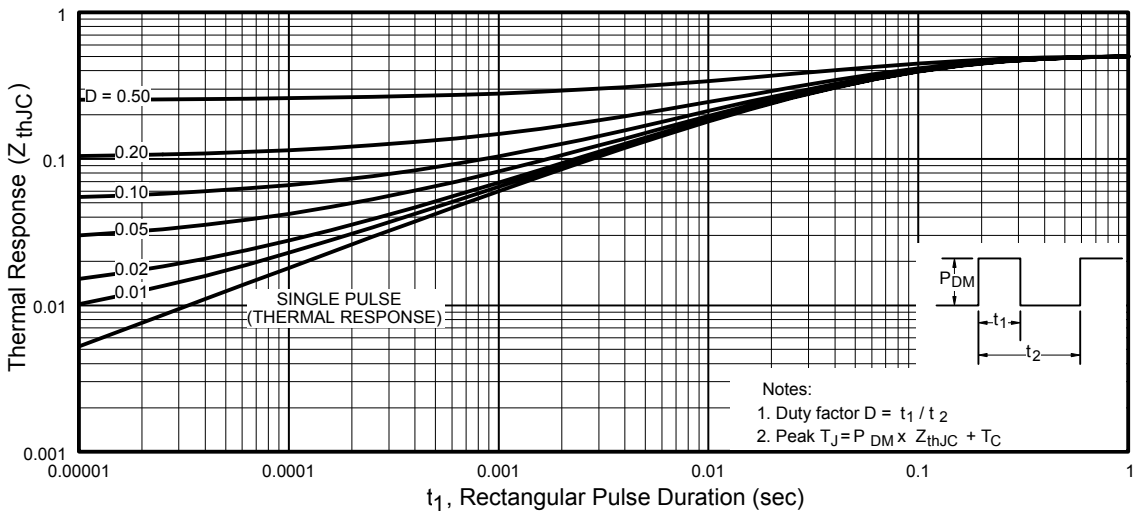

Fig 11. Maximum Effective Transient Thermal Impedance, Junction-to-Case

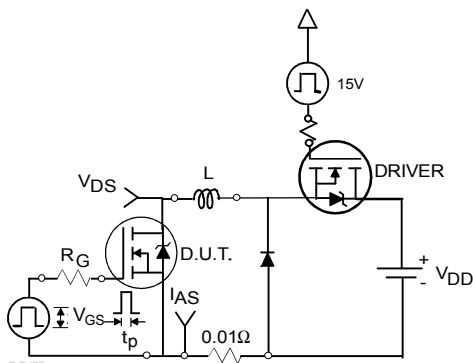

Fig 12a. Unclamped Inductive Test Circuit

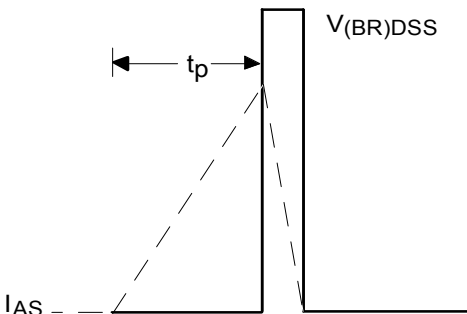

Fig 12b. Unclamped Inductive Waveforms

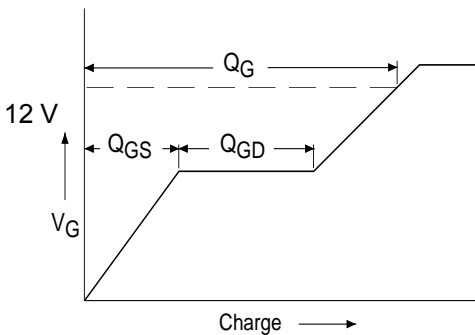

Fig 13a. Basic Gate Charge Waveform

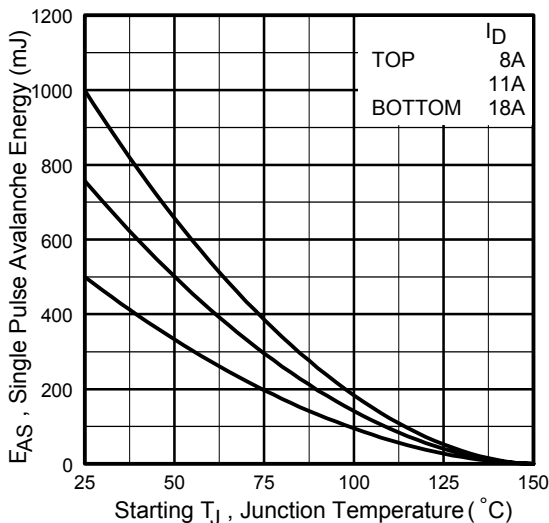

Fig 12c. Maximum Avalanche Energy Vs. Drain Current

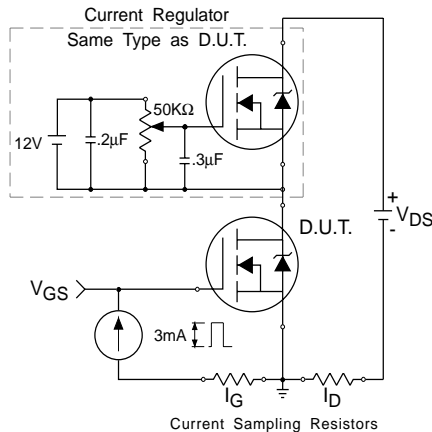

Fig 13b. Gate Charge Test Circuit

Footnotes:

- ① Repetitive Rating; Pulse width limited by maximum junction temperature.
- ② $V_{DD} = 50V$, starting $T_J = 25^{\circ}C$, $L = 3.1\text{ mH}$
Peak $I_L = 18A$, $V_{GS} = 12V$
- ③ $I_{SD} \leq 18A$, $di/dt \leq 110A/\mu s$,
 $V_{DD} \leq 500V$, $T_J \leq 150^{\circ}C$
- ④ Pulse width $\leq 300\ \mu s$; Duty Cycle $\leq 2\%$
- ⑤ **Total Dose Irradiation with V_{GS} Bias.**
12 volt V_{GS} applied and $V_{DS} = 0$ during irradiation per MIL-STD-750, method 1019, condition A.
- ⑥ **Total Dose Irradiation with V_{DS} Bias.**
400 volt V_{DS} applied and $V_{GS} = 0$ during irradiation per MIL-STD-750, method 1019, condition A.

Case Outline and Dimensions —TO-254AA

www.DataSheet4U.com

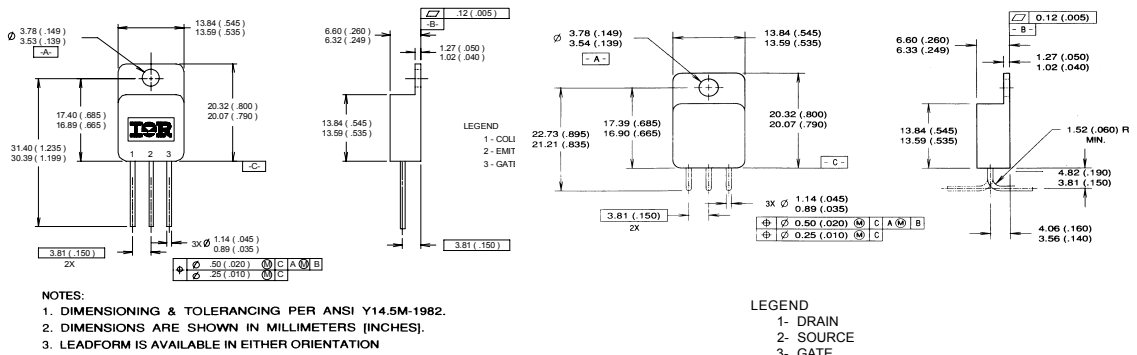

- NOTES:
 1. DIMENSIONING & TOLERANCING PER ANSI Y14.5M-1982.
 2. DIMENSIONS ARE SHOWN IN MILLIMETERS [INCHES].
 3. LEADFORM IS AVAILABLE IN EITHER ORIENTATION

CAUTION

BERYLLIA WARNING PER MIL-PRF-19500

Package containing beryllia shall not be ground, sandblasted, machined, or have other operations performed on them which will produce beryllia or beryllium dust. Furthermore, beryllium oxide packages shall not be placed in acids that will produce fumes containing beryllium.

International
IR Rectifier

IR WORLD HEADQUARTERS: 233 Kansas St., El Segundo, California 90245, USA Tel: (310) 252-7105
 TAC Fax: (310) 252-7903

Visit us at www.irf.com for sales contact information.
 Data and specifications subject to change without notice. 05/01
www.DataSheet4U.com