

www.DataSheet4U.com

# User's Manual

## MISTRAL2500

STEREO POWER  
AMPLIFIER

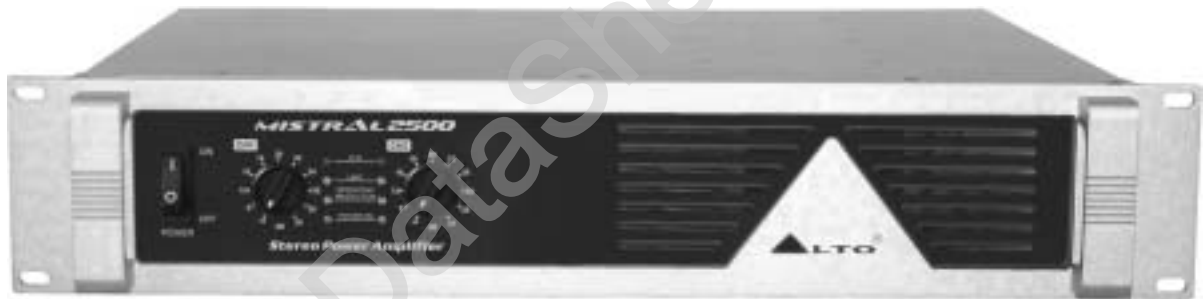

[www.altoproaudio.com](http://www.altoproaudio.com)

Version 1.0 DEC 2003

English —

www.DataSheet4U.com

## SAFETY RELATED SYMBOLS



The symbol is used to indicate that some hazardous live terminals are involved within this apparatus, even under the normal operating conditions.



The symbol is used in the service documentation to indicate that a specific component shall be only replaced by the component specified in that documentation for safety reasons.



Protective grounding terminal.



Alternating current /voltage.



Hazardous live terminal.

**ON:** Denotes the apparatus is turned on.

**OFF:** Denotes the apparatus is turned off, because it uses the single pole switch, be sure to unplug the AC power to prevent any electric shock before you proceed with your service.

**WARNING:** Describes precautions that should be observed to prevent the danger of injury or death to the user.

**CAUTION:** Describes precautions that should be observed to prevent danger of the apparatus.

### WARNING

#### • Power Supply

Ensures the source voltage matches the voltage of the power supply before turning ON the apparatus. Unplug this apparatus during lightning storms or when unused for long periods of time.

#### • External Connection

The external wiring connected to the output hazardous live terminals requires installation by an instructed person, or the use of ready-made leads or cords.

#### • Do not Remove any Cover

There are maybe some areas with high voltages inside, to reduce the risk of electric shock, do not remove any cover if the power supply is connected.

The cover should be removed by qualified personnel only.

No user serviceable parts inside.

#### • Fuse

To prevent a fire, make sure to use fuses with specified standard (current, voltage, type). Do not use a different fuse or short circuit the fuse holder.

Before replacing the fuse, turn OFF the apparatus and disconnect the power source.

#### • Protective Grounding

Make sure to connect the protective grounding to prevent any electric shock before turning ON the apparatus.

Never cut off the internal or external protective grounding wire or disconnect the wiring of protective grounding terminal.

#### • Operating Conditions

This apparatus shall not be exposed to dripping or splashing and that no objects filled with liquids, such as vases, shall be placed on this apparatus.

To reduce the risk of fire or electric shock, do not expose this apparatus to rain or moisture.

Do not use this apparatus near water.

Install in accordance with the manufacturer's instructions.

Do not install near any heat sources such as radiators, heat registers, stoves, or other apparatus (including amplifiers) that produce heat.

Do not block any ventilation openings.

No naked flame sources, such as lighted candles, should be placed on the apparatus.

### IMPORTANT SAFETY INSTRUCTIONS

- Read these instructions.
- Follow all instructions.
- Keep these instructions.
- Heed all warnings.
- Only use attachments/accessories specified by the manufacturer.

#### • Power Cord and Plug

Do not defeat the safety purpose of the polarized or grounding type plug. A polarized plug has two blades with one wider than the other. A grounding type plug has two blades and a third grounding prong. The wide blade or the third prong are provided for your safety. If the provided plug does not fit into your outlet, consult an electrician for replacement of the obsolete outlet. Protect the power cord from being walked on or pinched particularly at the plug, convenience receptacles, and the point where they exit from the apparatus.

#### • Cleaning

When the apparatus needs a cleaning, you can blow off dust from the apparatus with a blower or clean with a rag etc. Don't use solvents such as benzol, alcohol, or other fluids with very strong volatility and flammability for cleaning the apparatus body.

Clean only with a dry cloth.

#### • Servicing

Refer all servicing to qualified personnel. To reduce the risk of electric shock, do not perform any servicing other than that contained in the operating instructions unless you are qualified to do so.

Servicing is required when the apparatus has been damaged in any way, such as the power supply cord or plug is damaged, liquid has been spilled or objects have fallen into the apparatus, the apparatus has been exposed to rain or moisture, does not operate normally, or has been dropped.

## Preface

Dear Customer:

Thanks for choosing ▲LTO MISTRAL2500 Stereo Power Amplifier and thanks for choosing one of the results of ▲LTO AUDIO TEAM job and researches.

For our ▲LTO AUDIO TEAM, music and sound are more than a job ...are first of all passion and let us say...our obsession! We have been designing professional audio products for a long time in cooperation with some of the major brands in the world in the audio field.

The ▲LTO line presents unparalleled analogue and digital products made by Musicians for Musicians in our R&D Centers in Italy Netherlands, United Kingdom and Taiwan. The core of our digital audio products is a sophisticated DSP (Digital Sound Processor) and a large range of state of the art algorithms which have been developed by our Software Team for the last 7 years.

Because we are convinced you are the most important member of ▲LTO AUDIO TEAM and the one confirming the quality of our job, we'd like to share with you our work and our dreams, paying attention to your suggestions and your comments. Following this idea we create our products and we will create the new ones! From our side, we guarantee you and we will guarantee you also in future the best quality, and the best fruits of our continuous researches and the best prices.

Our ▲LTO MISTRAL2500 Stereo Power Amplifier is the result of many hours of listening and tests involving common people, area experts, musicians and technicians. The result of this effort is the sophisticated circuit design featuring high power and superb quality together with superior reliability and stability to provide the highest possible audio performance.

Nothing else to add, but that we would like to thank all the people that made the ▲LTO MISTRAL2500 Stereo Power Amplifier a reality available to our customers, and thank our designers and all the ▲LTO staff, there to make possible the realization of products containing our idea of music and sound and there to support you, our customers, In the best way, conscious that you are our best richness.

Thank you very much.

▲LTO AUDIO TEAM

## TABLE OF CONTENTS

<b>1. INTRODUCTION.....</b>	<b>4</b>
<b>2. FEATURES ....</b>	<b>4</b>
<b>3. CONTROL ELEMENTS.....</b>	<b>5</b>
3.1 The Front Panel	
3.2 The Rear Panel	
<b>4. APPLICATION.....</b>	<b>8</b>
4.1 Stereo Mode	
4.2 Bridge Mode	
<b>5. TECHNICAL SPECIFICATIONS.....</b>	<b>11</b>
<b>6. WARRANTY .....</b>	<b>12</b>

## 1. ▲LTO MISTRAL2500

The ▲LTO MISTRAL is a line of high power, low profile, professional Power Amplifiers with advanced features and great reliability. They deliver tremendous power in only two rack spaces, providing high level performance under the most demanding conditions. An automatic speed fan matches cooling capacity with heat requirements. The amplifier frame contains all solid-state circuitry, using complementary silicon output devices. The amplifier is supplied with a single moulded AC cord having an appropriate AC plug for the intended operating voltage. The amplifier employs forced air cooling with a variable speed fan for minimum acoustic noise. Air flow is from rear to front to avoid temperature rise inside the Rack. The amplifier contains two independent channels, with separate AC transformer secondaries, power supplies and protection system. All protection systems, except the main AC one, are self resetting upon removal of fault, and the remaining channel shall continue to operate. Each channel has independent protective circuitry against open circuit, short circuit, mismatched loads and over temperature. Each channel has also a main LED that becomes green for power-on indicator and red for muting or protection, another red LED that shows true amplifier clipping and a yellow one for the Limiter stage. The power outputs employ standard power connectors. All the inputs are electronically balanced and an high quality audio transformer can be added on the input stage of each channel.

## 2. FEATURES

- 2U rack, stereo high power amplifier.
- Fantastic audio quality even with extremely high volume levels.
- Solid and durable, can be mounted into a cabinet.
- User-controllable clip limiter
- 2x700 Watts (EIAJ) RMS on 4 ohms for MISTRAL2500
- Stereo (dual-channel), or bridge mono operating modes.
- Balanced XLR inputs / parallel outputs to ensure noiseless long wiring.
- Binding post and Neutrik Speak-on connectors for output.
- Single channel, bridge, and bi-amp output wiring possibility.
- Front panel LED indicators for operating/protection, limit, power on and clip.
- Accurate gain control
- Independent DC and thermal overload protection on each channel automatically protects amplifier and speakers.
- Single channel over-heat protection.
- Manufactured under QS9000, VDA 6.1 certified management system.

### 3. CONTROL ELEMENTS

#### 3.1 Front Panel

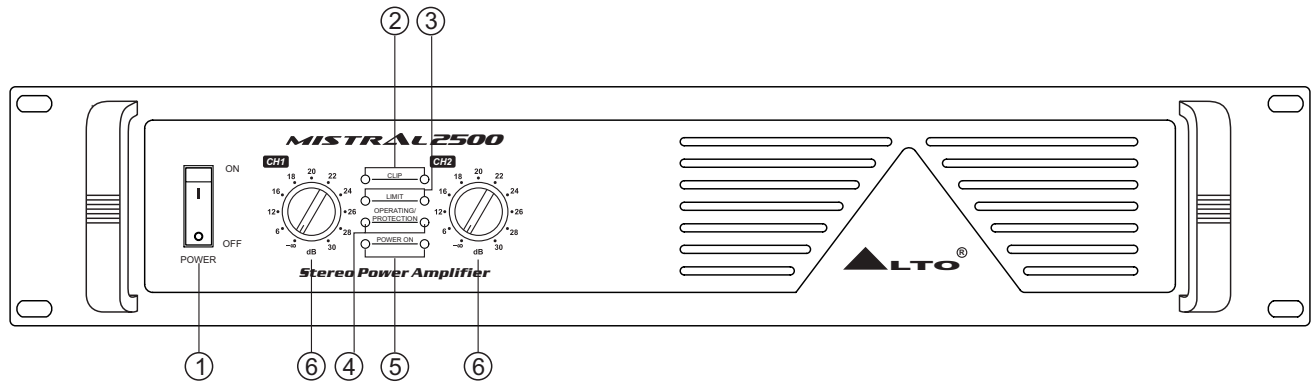

#### ① Power Switch

Turn the unit power on or off.

#### ② Clip Led

When the signal distortion reaches or surpasses 0.5%, the Led lights up. This means the output level of signal source is too high and it is time to reduce input level until clip led turning off.

#### ③ Output Limiter Led

While the unit is limiting the output signal, the Led lighting up.

#### ④ Operation and protection Led

In normal operation, the Led is green; If the Led is red, it means the unit is in heat protection, no signal output at the time and over-heat inside the unit (the surface temperature of power transistor is 110°C), the temperature must be lowered through better ventilation and decrease the signal level etc. After the temperature dropped, the protection stop and meanwhile the Led turning off with the unit recover normal work.

#### ⑤ Power Led

This Led lights up when the unit is powered.

#### ⑥ Level Control for Channels 1 & 2

Adjust the output signal level to avoid signal distortion.

#### 3.2 Rear Panel

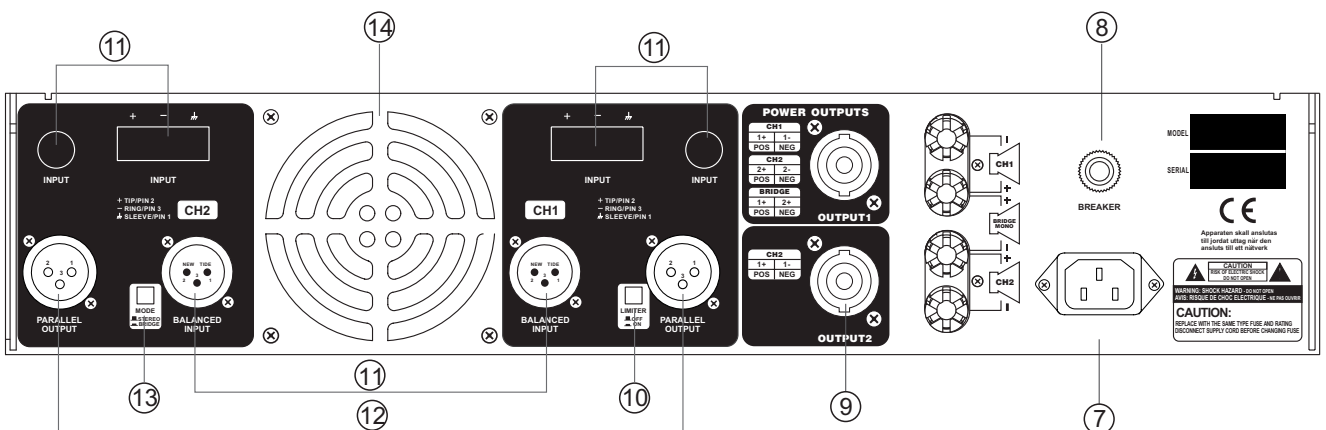

### ⑦ Power Source Socket

It is used to connect power cord, after setting the proper voltage, connect one end of power cord with the unit and another end with mains.

### ⑧ Manual Reset Pushing-Button

This switch works as fuse for protecting the unit from damage. When the unit is overloaded or the temperature inside the unit is too high, this pushing-button will spring up and break the power supply. The power supply will be restored with pushing this switch down again.

### ⑨ Output Connector

These connectors have two kinds: Binding post and Neutrik connector. You can choose proper connectors according to practical need. For your safety, please be careful when do connecting work.

### ⑩ Clip Switch

Set this switch at "ON" position, once the output level is above maximum output level, the clip begin, thus keeping consistent output level for protecting apparatus. If the switch is set at "OFF", this clip function doesn't work.

### ⑪ Balanced Input Connector

These connectors connect the input signal of channel1 and channel 2 separately.

### ⑫ Balanced Output Connector

These two output connectors are paralleled inside with input connectors. It enables the unit work under Paralleled mode. Please also refer to wiring diagram for paralleled mode.

### ⑬ Mode Selector

Total two optional modes: Up for Stereo mode; Down for Bridge mode.

#### - Stereo

In this mode, Channel 1 and Channel 2 operate independently ( just as traditional stereo amplifier). The signal input into channel 1 can be output from channel 1 only, similarly, the signal input into channel 2 can be output from channel 2 only.

You can also operate the paralleled mode via outside wiring, so, the signal input from channel 1 or 2 will be output from both channel 1 and 2 simultaneously. Details refer to the chapter 4.

#### - Bridge

In this mode, the signal input into channel 1 will be output from the bridged end, on other hand, the output level control of channel 2 should be turn down to smallest.

### ⑭ Fan

The fan can accelerate the flow of air to lower the temperature inside unit. The inside temperature determines the fan speed which controls the inside air flowing speed.

## 4. APPLICATION

Total two optional modes:

Please see following diagram for connecting the power amplifier into your audio system.

### 4.1 Stereo Mode

In this mode, Channel 1 and Channel 2 operate independently ( just as traditional stereo amplifier). The signal input into channel 1 can be output from channel 1 only, similarly, the signal input into channel 2 can be output from channel 2 only.

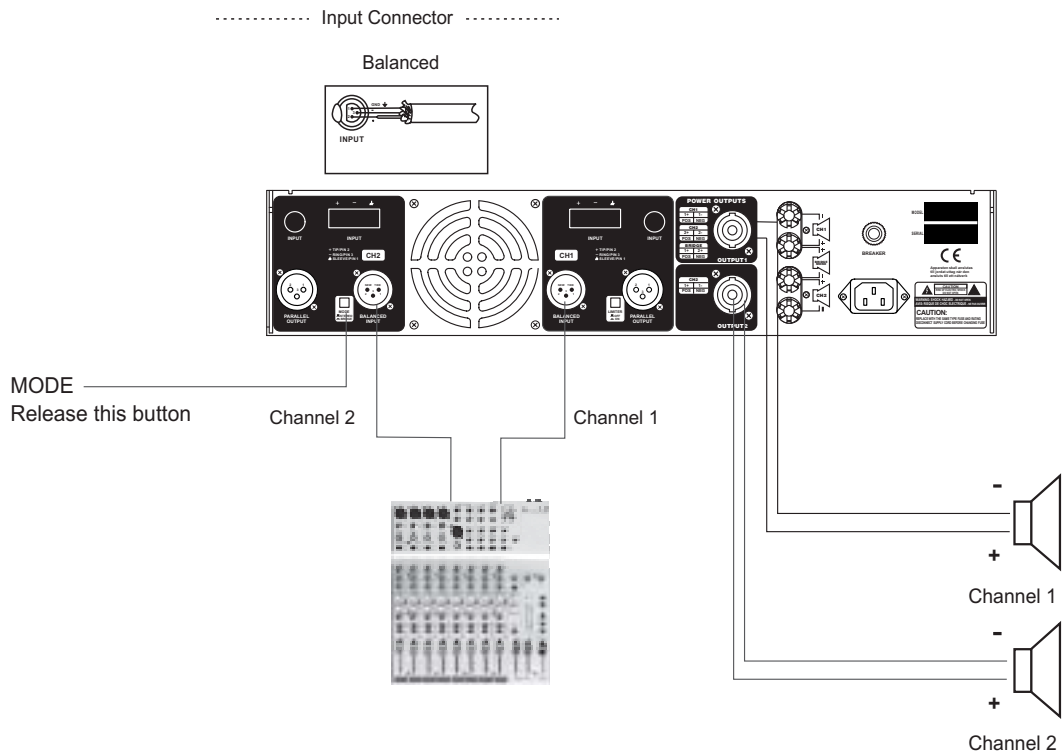
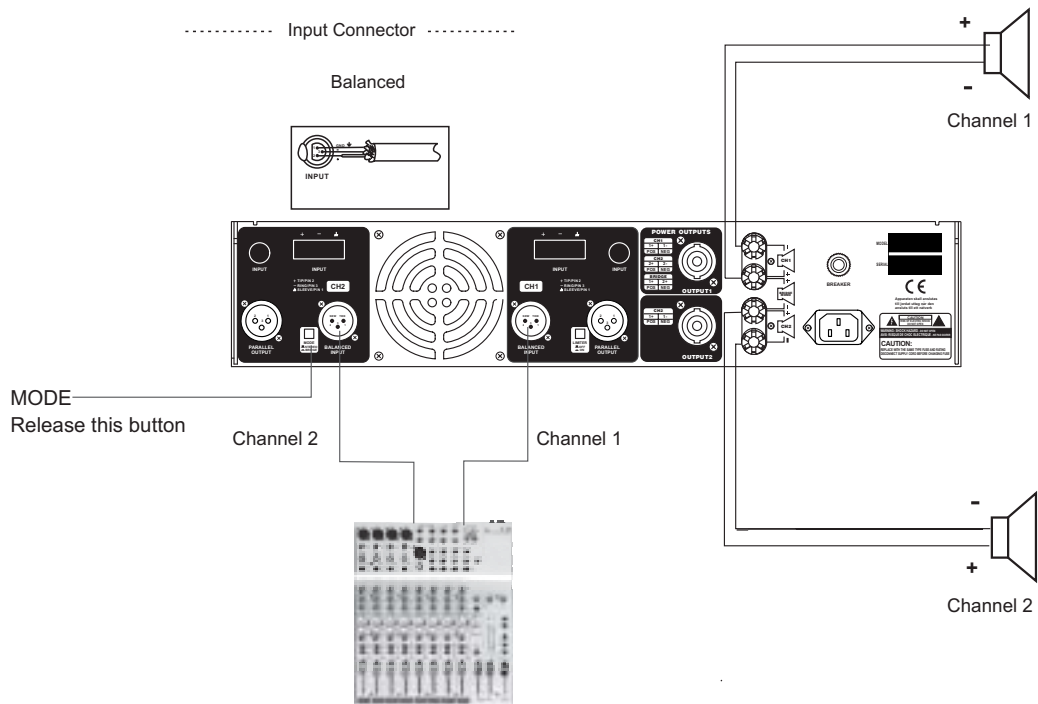



You can also operate the paralleled mode via outside wiring, so, the signal input from channel 1 or 2 will be output from both channel 1 and 2 simultaneously. The volume of channel 1 or channel 2 can be controlled separately.

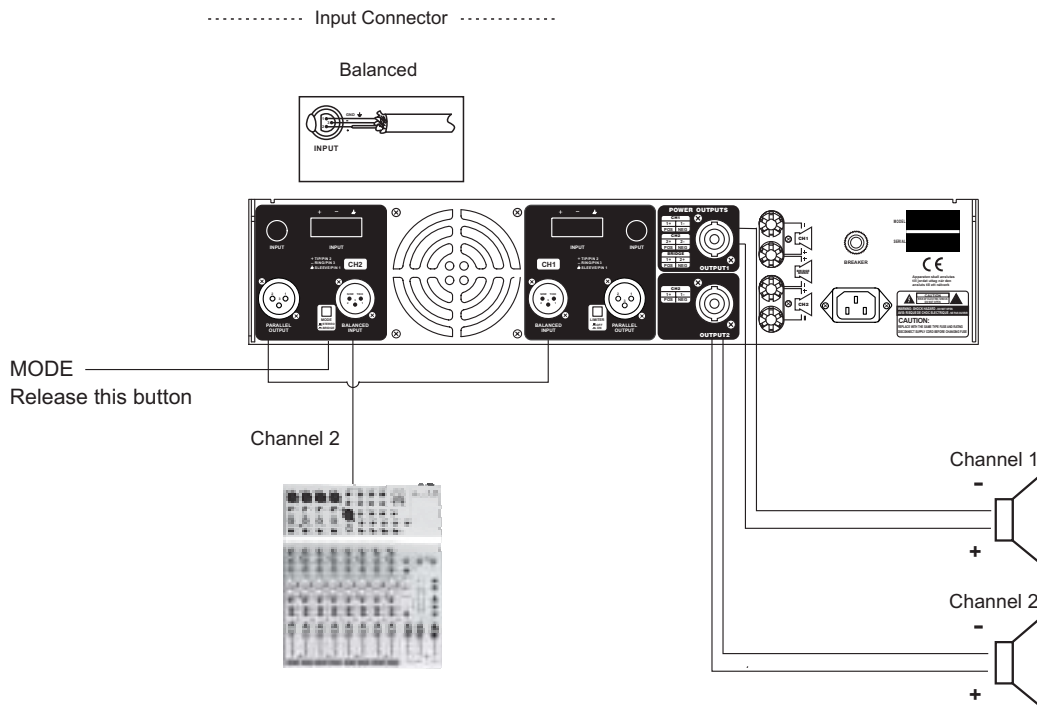
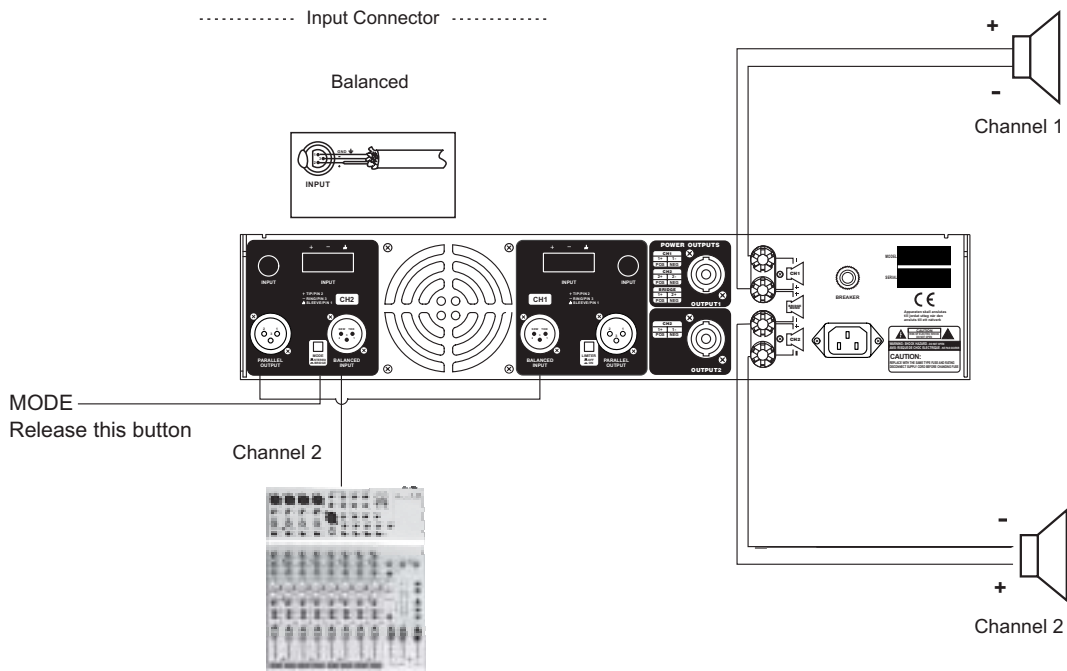

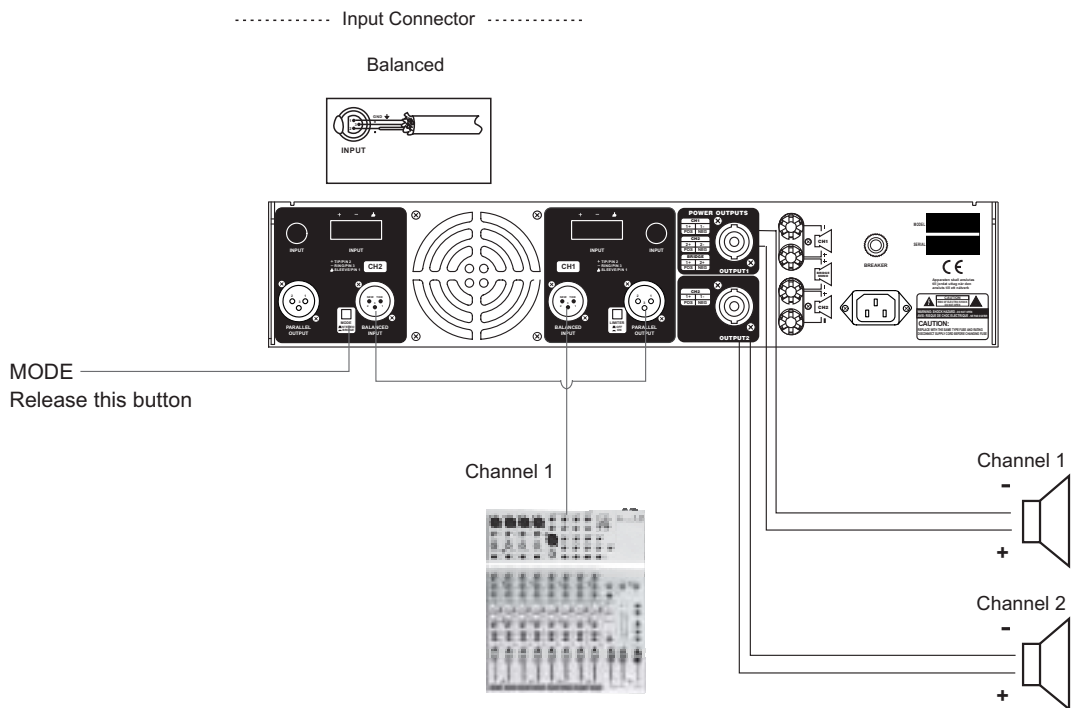
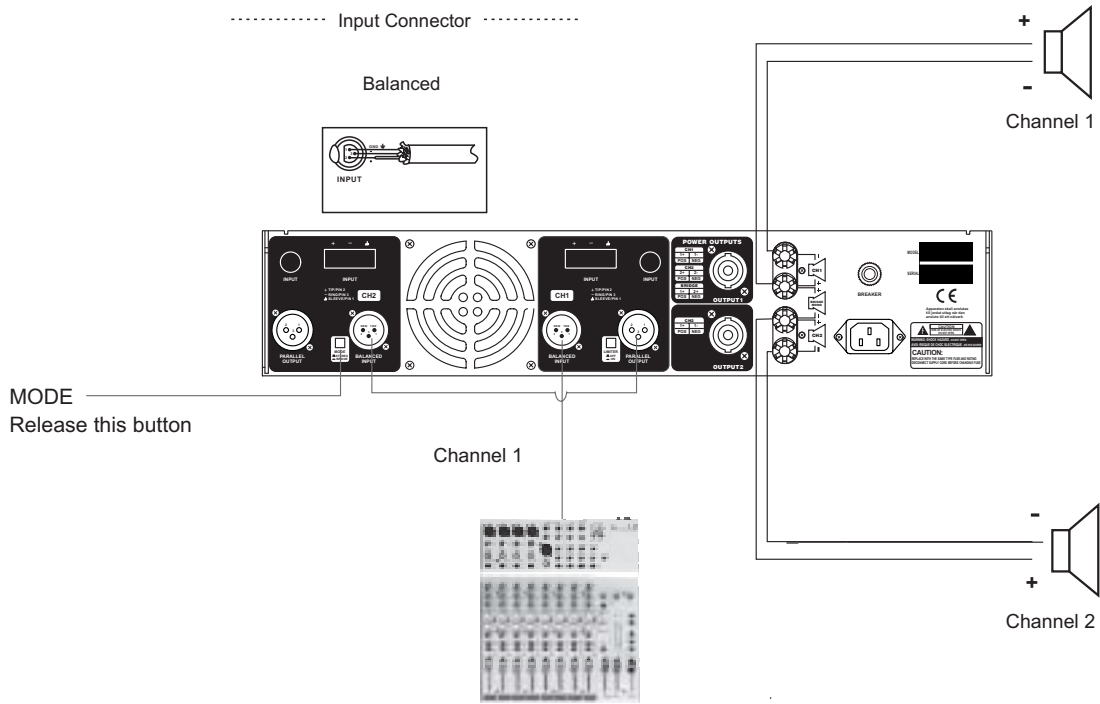

## 4.2 Bridge Mode

In this mode, the signal input into channel 1 will be output from the bridged end, on other hand, the output level control of channel 2 should be turn down to smallest (turn the volume control at counterclockwise). Only the volume control of channel 1 is used to control the volume of whole system.

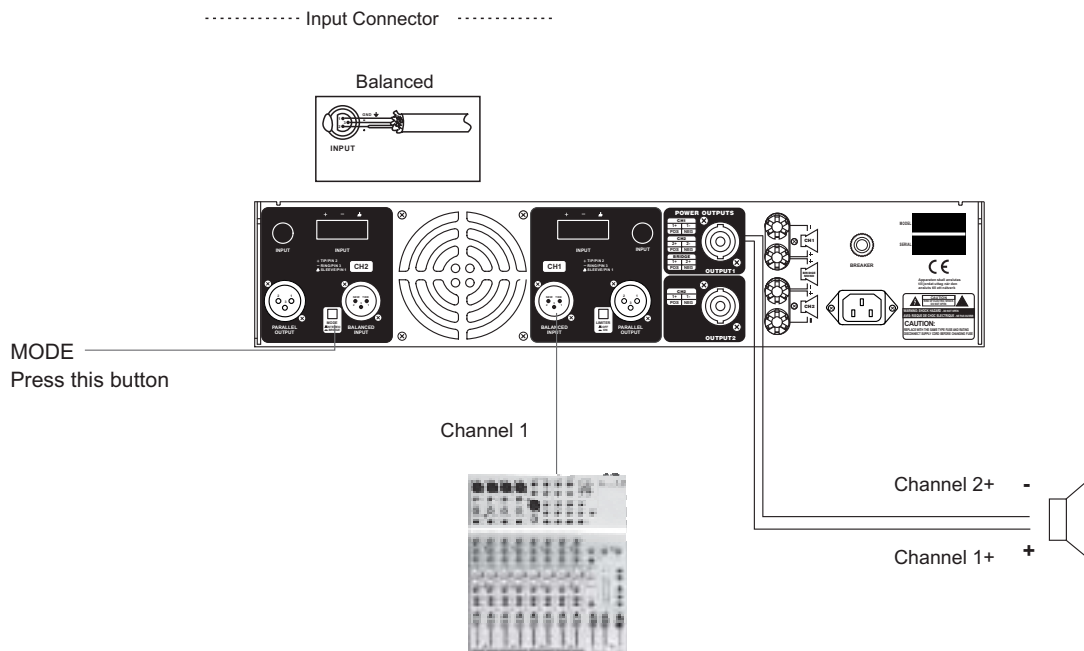
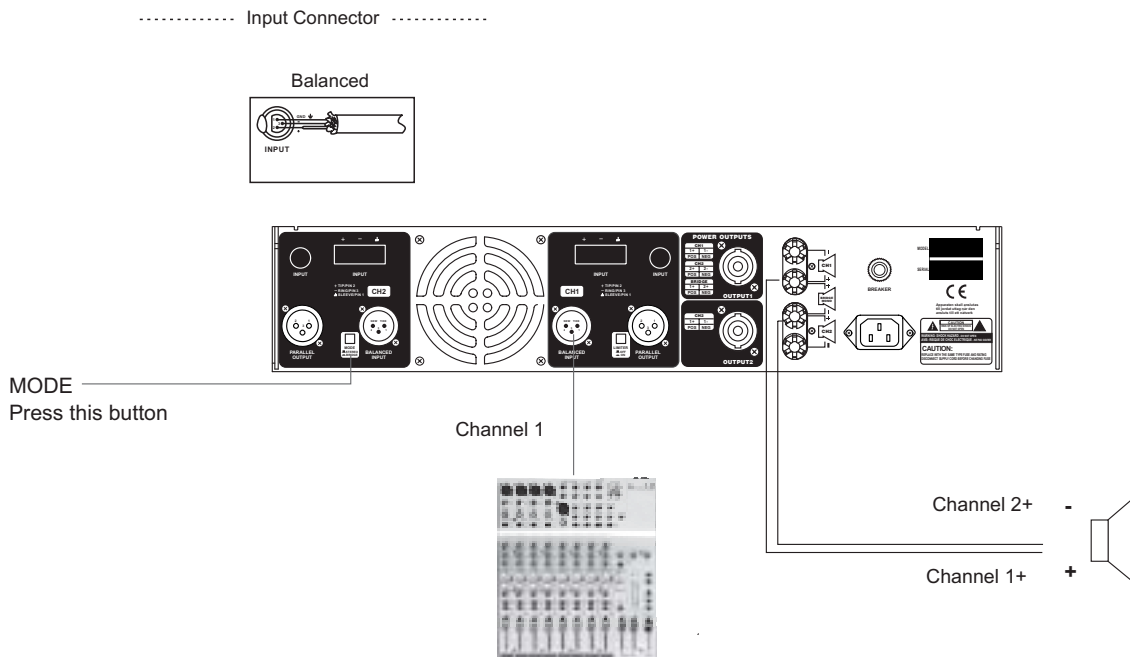

## 5. TECHNICAL SPECIFICATIONS

<b>MODEL</b>	<b>MISTRAL2500</b>
<b>Output Power</b>	
20Hz 20KHz@0.1%THD, Stereo Mode	
8 ohms per channel(EIAJ)	450W
4 ohms per channel(EIAJ)	700W
<b>Bridge Mono Mode</b>	
8 ohms, 1KHz, 0.1%THD	1400W
<b>Distortion (SMPTE-IM)</b>	<0.05%
<b>Frequency Response</b>	20Hz-20KHz $\pm$ 1dB, -3dB points: 10Hz-60KHz
<b>Damping Factor, 1 kHz and below</b>	>300 at 8ohms
<b>Signal to Noise,20Hz-20KHz</b>	102dB
<b>Voltage Gain</b>	40x (32dB)
<b>Input Sensitivity @ 4 ohms</b>	1Vrms
<b>Input Clipping</b>	10Vrms (+22dB)
<b>Input Impedance</b>	10K ohms unbalanced, 20K ohms balanced 56 (36dB)
<b>Controls</b>	FRONT: AC SWITCH, CH1 & CH2 GAIN KNOBS REAR: LIMITER, BRIDGE SELECTOR
<b>Indicators (1 per channel)</b>	Power-On: Blue LED Operation/Protection : Dual Color (Green/Red LED) Limit: Red LED Clip: Red LED
<b>Connectors, each channel</b>	Input: Active balanced XLR Parallel Output : XLR Output: NEUTRIK <sup>®</sup> Speakon and Binding posts
<b>Cooling</b>	Continuously variable-speed fan, rear-to-front air flow
<b>Load Protection</b>	On/off muting, DC-fault load grounding relay. Internal fault fuses.
<b>Power Requirements</b>	200-240(100-120) Vac 50~60Hz
<b>Dimensions</b>	19" (48.3 cm) rack mounting, 3.5" (8.9 cm) tall (2 rack spaces), 15.9" (40 cm) deep (rack mounting to rear support ears)
<b>Net Weight</b>	20.3Kg

\*PRELIMINART

## 6. WARRANTY

### 1. WARRANTY REGISTRATION CARD

To obtain Warranty Service, the buyer should first fill out and return the enclosed Warranty Registration Card within 10 days of the Purchase Date.

All the information presented in this Warranty Registration Card gives the manufacturer a better understanding of the sales status, so as to purport a more effective and efficient after-sales warranty service.

Please fill out all the information carefully and genuinely, miswriting or absence of this card will void your warranty service.

### 2. RETURN NOTICE

2.1 In case of return for any warranty service, please make sure that the product is well packed in its original shipping carton, and it can protect your unit from any other extra damage.

2.2 Please provide a copy of your sales receipt or other proof of purchase with the returned machine, and give detail information about your return address and contact telephone number.

2.3 A brief description of the defect will be appreciated.

2.4 Please prepay all the costs involved in the return shipping, handling and insurance.

### 3. TERMS AND CONDITIONS

3.1 ▲LTO warrants that this product will be free from any defects in materials and/or workmanship for a period of 1 year from the purchase date if you have completed the Warranty Registration Card in time.

3.2 The warranty service is only available to the original consumer, who purchased this product directly from the retail dealer, and it can not be transferred.

3.3 During the warranty service, ▲LTO may repair or replace this product at its own option at no charge to you for parts or for labor in accordance with the right side of this limited warranty.

3.4 This warranty does not apply to the damages to this product that occurred as the following conditions:

- Instead of operating in accordance with the user's manual thoroughly, any abuse or misuse of this product.
- Normal tear and wear.
- The product has been altered or modified in any way.
- Damage which may have been caused either directly or indirectly by another product / force / etc.
- Abnormal service or repairing by anyone other than the qualified personnel or technician.

And in such cases, all the expenses will be charged to the buyer.

3.5 In no event shall ▲LTO be liable for any incidental or consequential damages. Some states do not allow the exclusion or limitation of incidental or consequential damages, so the above exclusion or limitation may not apply to you.

3.6 This warranty gives you the specific rights, and these rights are compatible with the state laws, you may also have other statutory rights that may vary from state to state.

**SEIKAKU TECHNICAL GROUP LIMITED**  
**No. 1, Lane 17, Sec. 2, Han Shi W. Road, Taichung, 401 Taiwan**  
**<http://www.altomobile.com> Tel: 886-4-22313737**  
**email: [info@altomobile.com](mailto:info@altomobile.com) Fax: 886-4-22346757**

All rights reserved to ALTO Mobile. Due to continued development in response to customer feedback, product features, specifications and/or internal/external design may be changed without prior notice. No photocopying, translation or reproduction of any part of this user manual is allowed without prior written permission. Copyright © 2004 Seikaku Technical Group Limited.