

MIW3000 Series

5-6W, Wide Input Range DIP, Single & Dual Output DC/DC Converters

Key Features

- Efficiency up to 86%
- 1500VDC Isolation
- MTBF > 1,000,000 Hours
- 2:1 Wide Input Range
- UL 1950 Safety Approval
- Complies with EN55022 Class A
- Temperature Performance -40°C to $+71^{\circ}\text{C}$
- Industry Standard Pinout
- UL 94V-0 Package Material
- Internal SMD Construction



Minmax's MIW3000-Series Power modules are low-profile dc-dc converters that operate over input voltage ranges of 4.5-7VDC, 9-18VDC, 18-36VDC and 36-75VDC which provide precisely regulated output voltages of 3.3V, 5V, 12V, 15V, $\pm 5\text{V}$, $\pm 12\text{V}$ and $\pm 15\text{VDC}$.

The -40°C to $+71^{\circ}\text{C}$ operating temperature range makes it ideal for data communication equipments, mobile battery driven equipments, distributed power systems, telecommunication equipments, mixed analog/digital subsystems, process/machine control equipments, computer peripheral systems and industrial robot systems.

The modules have a maximum power rating of 6W and a typical full-load efficiency of 86%, continuous short circuit, 50mA output ripple, EN55022 Class A conducted noise compliance minimize design-in time, cost and eliminate the need for external filtering.

High Power Density

More Power

1500 VDC

I/O Isolation

EMI

EN55022

2:1

Wide Range

Block Diagram

Single Output

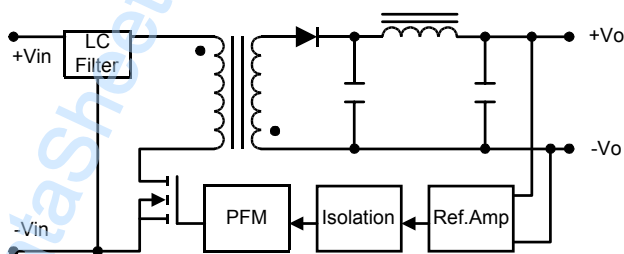

Dual Output

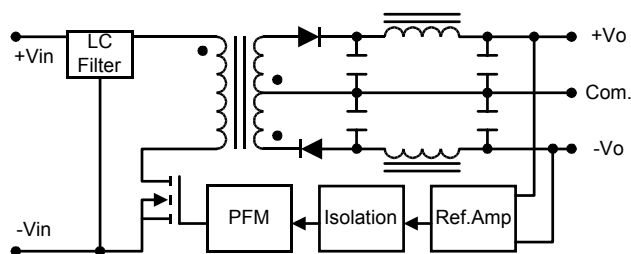

Model Selection Guide

Model Number	Input Voltage	Output Voltage	Output Current		Input Current		Reflected Ripple Current	Efficiency
			Max.	Min.	@Max. Load	@No Load		
	VDC	VDC	mA	mA	mA (Typ.)	mA (Typ.)	mA (Typ.)	% (Typ.)
MIW3011	5 (4.5 ~ 7)	3.3	1200	60	1056	70	100	75
MIW3012		5	1000	50	1265			79
MIW3013		12	500	25	1463			82
MIW3014		15	400	20	1463			82
MIW3015		±5	±500	±25	1265			79
MIW3016		±12	±250	±12.5	1463			82
MIW3017		±15	±200	±10	1463			82
MIW3021		12 (9 ~ 18)	3.3	1200	60			429
MIW3022	5		1000	50	514	81		
MIW3023	12		500	25	595	84		
MIW3024	15		400	20	595	84		
MIW3025	±5		±500	±25	514	81		
MIW3026	±12		±250	±12.5	595	84		
MIW3027	±15		±200	±10	595	84		
MIW3031	24 (18 ~ 36)		3.3	1200	60	209	5	15
MIW3032		5	1000	50	251	83		
MIW3033		12	500	25	291	86		
MIW3034		15	400	20	291	86		
MIW3035		±5	±500	±25	251	83		
MIW3036		±12	±250	±12.5	291	86		
MIW3037		±15	±200	±10	291	86		
MIW3041		48 (36 ~ 75)	3.3	1200	60	104		
MIW3042	5		1000	50	126	83		
MIW3043	12		500	25	145	86		
MIW3044	15		400	20	145	86		
MIW3045	±5		±500	±25	126	83		
MIW3046	±12		±250	±12.5	145	86		
MIW3047	±15		±200	±10	145	86		

Absolute Maximum Ratings

Parameter	Min.	Max.	Unit	
Input Surge Voltage (1000 mS)	5VDC Input Models	-0.7	10	VDC
	12VDC Input Models	-0.7	25	VDC
	24VDC Input Models	-0.7	50	VDC
	48VDC Input Models	-0.7	100	VDC
Lead Temperature (1.5mm from case for 10 Sec.)	---	260	°C	
Internal Power Dissipation	---	2,500	mW	

Exceeding the absolute maximum ratings of the unit could cause damage. These are not continuous operating ratings.

Environmental Specifications

Parameter	Conditions	Min.	Max.	Unit
Operating Temperature	Ambient	-40	+71	°C
Operating Temperature	Case	-40	+90	°C
Storage Temperature		-40	+125	°C
Humidity		---	95	%
Cooling	Free-Air Convection			
Conducted EMI	EN55022 Class A			

Notes :

- Specifications typical at $T_a=+25^{\circ}\text{C}$, resistive load, nominal input voltage, rated output current unless otherwise noted.
- Transient recovery time is measured to within 1% error band for a step change in output load of 75% to 100%.
- Ripple & Noise measurement bandwidth is 0-20 MHz.
- These power converters require a minimum output loading to maintain specified regulation.
- Operation under no-load conditions will not damage these modules; however, they may not meet all specifications listed.
- All DC/DC converters should be externally fused at the front end for protection.
- Other input and output voltage may be available, please contact factory.
- Specifications subject to change without notice.

MIW3000 Series

Input Specifications

Parameter	Model	Min.	Typ.	Max.	Unit
Start Voltage	5V Input Models	3	3.5	4.4	VDC
	12V Input Models	4.5	6	8	
	24V Input Models	8	12	16	
	48V Input Models	16	24	32	
Under Voltage Shutdown	5V Input Models	---	---	4	
	12V Input Models	---	---	8	
	24V Input Models	---	---	16	
	48V Input Models	---	---	32	
Reverse Polarity Input Current	All Models	---	---	1	A
Short Circuit Input Power	All Models	---	1000	3000	mW
Input Filter	Pi Filter				

Output Specifications

Parameter	Conditions	Min.	Typ.	Max.	Unit
Output Voltage Accuracy		---	± 0.5	± 1.0	%
Output Voltage Balance	Dual Output, Balanced Loads	---	± 0.5	± 2.0	%
Line Regulation	$V_{in} = \text{Min. to Max.}$	---	± 0.1	± 0.3	%
Load Regulation	$I_o = 20\% \text{ to } 100\%$	---	± 0.3	± 1.0	%
Ripple & Noise (20MHz)		---	50	75	mV P-P
Ripple & Noise (20MHz)	Over Line, Load & Temp.	---	---	100	mV P-P
Ripple & Noise (20MHz)		---	---	15	mV rms
Over Power Protection		120	---	---	%
Transient Recovery Time	25% Load Step Change	---	150	300	μs
Transient Response Deviation		---	± 2	± 6	%
Temperature Coefficient		---	± 0.01	± 0.02	$\%/^{\circ}\text{C}$
Output Short Circuit	Continuous				

General Specifications

Parameter	Conditions	Min.	Typ.	Max.	Unit
Isolation Voltage Rated	60 Seconds	1500	---	---	VDC
Isolation Voltage Test	Flash Tested for 1 Second	1650	---	---	VDC
Isolation Resistance	500VDC	1000	---	---	M Ω
Isolation Capacitance	100KHz, 1V	---	380	500	pF
Switching Frequency		---	300	---	KHz
MTBF	MIL-HDBK-217F @ 25°C, Ground Benign	1,000	---	---	K Hours

Capacitive Load

Models by Vout	3.3V	5V	12V	15V	$\pm 5V$ #	$\pm 12V$ #	$\pm 15V$ #	Unit
Maximum Capacitive Load	6800	6800	6800	6800	1000	1000	1000	μF

For each output

Input Fuse Selection Guide

5V Input Models	12V Input Models	24V Input Models	48V Input Models
3000mA Slow – Blow Type	1500mA Slow – Blow Type	700mA Slow – Blow Type	350mA Slow – Blow Type

Input Voltage Transient Rating

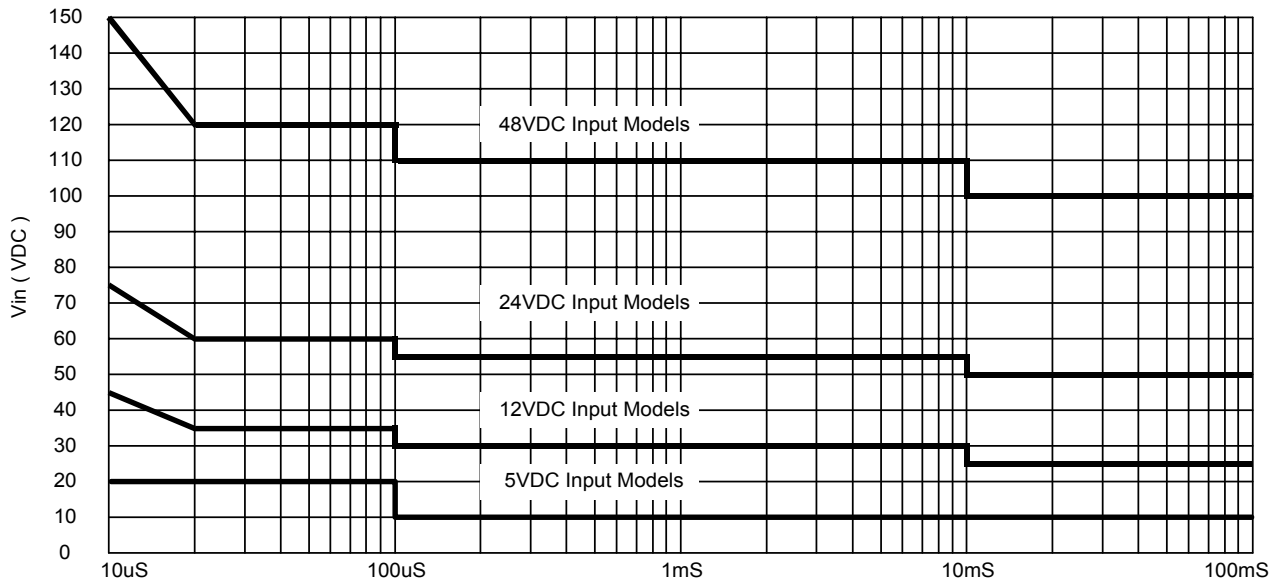

MIW3000 Series

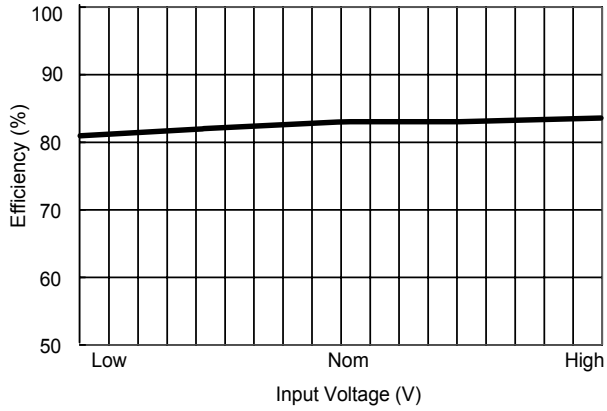

Efficiency vs Input Voltage (Single Output)

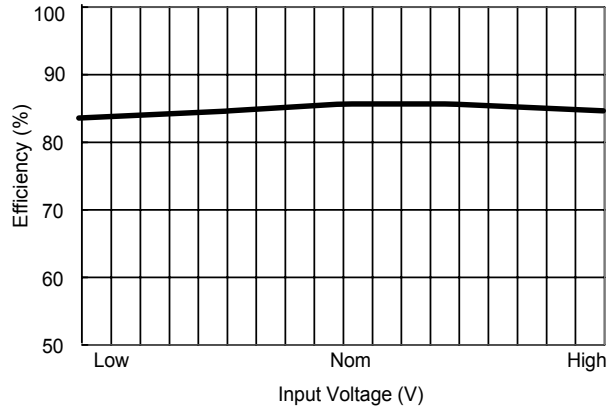

Efficiency vs Input Voltage (Dual Output)

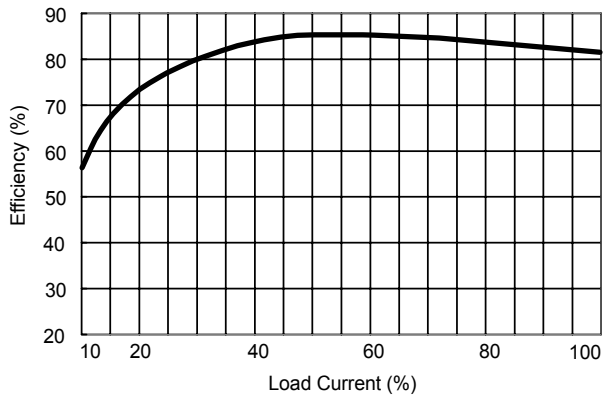

Efficiency vs Output Load (Single Output)

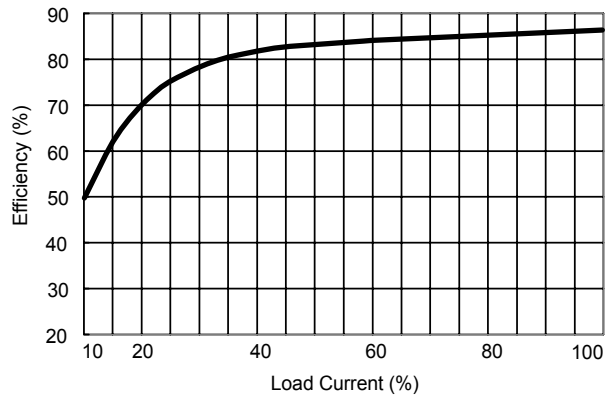

Efficiency vs Output Load (Dual Output)

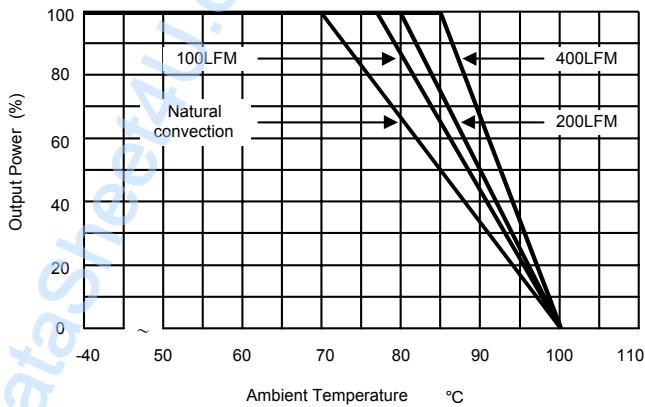

Derating Curve

Test Configurations

Input Reflected-Ripple Current Test Setup

Input reflected-ripple current is measured with an inductor L_{in} (4.7uH) and C_{in} (220uF, ESR < 1.0Ω at 100 KHz) to simulate source impedance.

Capacitor C_{in} , offsets possible battery impedance.

Current ripple is measured at the input terminals of the module, measurement bandwidth is 0–500 KHz.

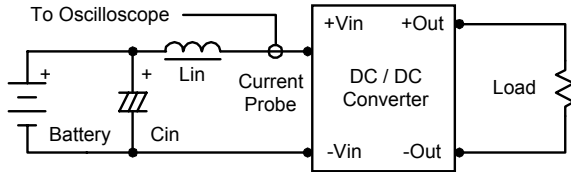

Peak-to-Peak Output Noise Measurement Test

Use a C_{out} 0.47uF ceramic capacitor.

Scope measurement should be made by using a BNC socket, measurement bandwidth is 0–20 MHz. Position the load between 50 mm and 75 mm from the DC/DC Converter.

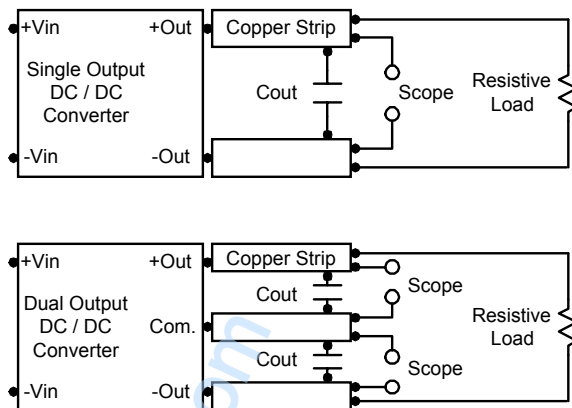

Design & Feature Considerations

Maximum Capacitive Load

The MIW3000 series has limitation of maximum connected capacitance at the output.

The power module may be operated in current limiting mode during start-up, affecting the ramp-up and the startup time.

For optimum performance we recommend 1000uF maximum capacitive load for dual outputs and 6800uF capacitive load for single outputs.

The maximum capacitance can be found in the data sheet.

Overcurrent Protection

To provide protection in a fault (output overload) condition, the unit is equipped with internal current limiting circuitry and can endure current limiting for an unlimited duration. At the point of current-limit inception, the unit shifts from voltage control to current control. The unit operates normally once the output current is brought back into its specified range.

Input Source Impedance

The power module should be connected to a low ac-impedance input source. Highly inductive source impedances can affect the stability of the power module.

In applications where power is supplied over long lines and output loading is high, it may be necessary to use a capacitor at the input to ensure startup.

Capacitor mounted close to the power module helps ensure stability of the unit, it is recommended to use a good quality low Equivalent Series Resistance (ESR < 1.0Ω at 100 KHz) capacitor of a 10uF for the 5V input devices, a 3.3uF for the 12V input devices and a 2.2uF for the 24V and 48V devices.

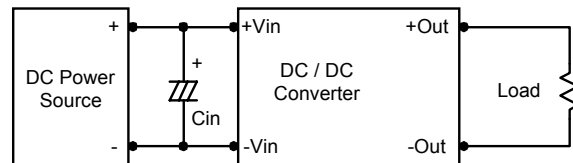

Output Ripple Reduction

A good quality low ESR capacitor placed as close as practicable across the load will give the best ripple and noise performance.

To reduce output ripple, it is recommended to use 3.3uF capacitors at the output.

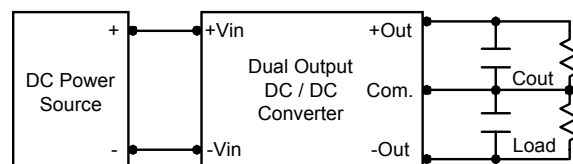
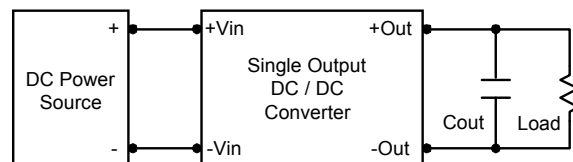

MIW3000 Series

Thermal Considerations

Many conditions affect the thermal performance of the power module, such as orientation, airflow over the module and board spacing. To avoid exceeding the maximum temperature rating of the components inside the power module, the case temperature must be kept below 90°C.

The derating curves are determined from measurements obtained in an experimental apparatus.

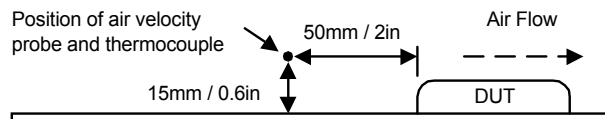

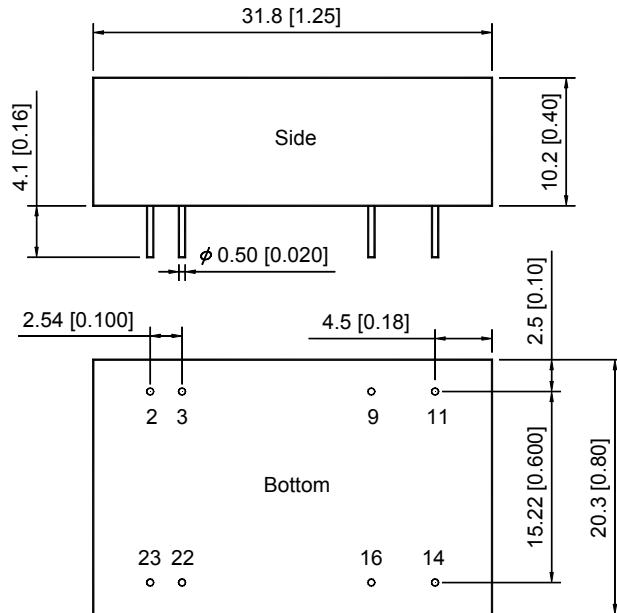
Mechanical Dimensions

Tolerance	Millimeters	Inches
	X.X±0.25	X.XX±0.01
	X.XX±0.13	X.XXX±0.005
Pin	±0.05	±0.002

Connecting Pin Patterns

Top View (2.54 mm / 0.1 inch grids)

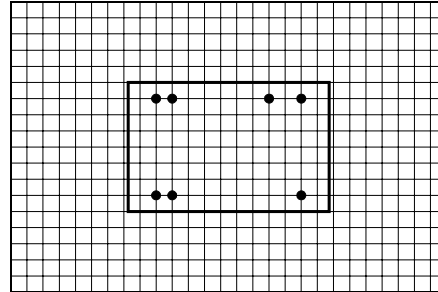
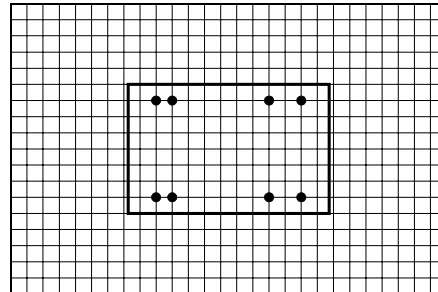
Single Output**Dual Output****Pin Connections**

Pin	Single Output	Dual Output
2	-Vin	-Vin
3	-Vin	-Vin
9	No Pin	Common
11	NC	-Vout
14	+Vout	+Vout
16	-Vout	Common
22	+Vin	+Vin
23	+Vin	+Vin

NC: No Connection

Physical Characteristics

Case Size	: 31.8×20.3×10.2 mm 1.25×0.80×0.40 inches
Case Material	: Metal With Non-Conductive Baseplate
Weight	: 16.9g
Flammability	: UL94V-0

The MIW3000 converter is encapsulated in a low thermal resistance molding compound that has excellent resistance/electrical characteristics over a wide temperature range or in high humidity environments.

The encapsulant and unit case are both rated to UL 94V-0 flammability specifications.

Leads are tin plated for improved solderability.