



## MIX2912

## 5. 5W 单通道电荷泵升压防破音 F 类功放

### 描述

MIX2912是专用于蓝牙音响的单通道内置电荷泵升压 F类功放，带有防破音功能。

MIX2912的差分输入架构有效地提高了对RF噪声的抑制能力。防破音功能解决了不同音源输出幅度不一致的问题，同时带来不失真的完美音乐享受。无需滤波器的PWM调制结构及反馈电阻内置的方式减少了外部元件、PCB面积和系统成本,并简化了设计。高效率的自适应电荷泵升压功能，快速启动时间和纤小的封装尺寸使得MIX2912成为蓝牙音箱和其他便携式音频产品的最佳选择。

MIX2912具有关断功能，极大的延长系统的待机时间。过热保护功能增强系统的可靠性。POP声抑制功能改善了系统的听觉感受，同时简化系统调试。

MIX2912采用ESOP16封装。

### 特性

- D类输出功率(NCN OFF):
  - 5.5W ( $V_{bat}=4.2V$ ,  $R_L=3\Omega$ ,  $THD+N=10\%$ )
  - 4.6W ( $V_{bat}=4.2V$ ,  $R_L=4\Omega$ ,  $THD+N=10\%$ )
- 工作电压 : 2.5V to 4.5V
- 低失真和低噪声
- 自适应升压功能，效率高
- 两种防破音模式可选
- 开机POP声抑制功能
- 启动时间: 32mS – 130mS可调

### 应用

- 蓝牙音箱
- WIFI音箱

### 典型应用电路图

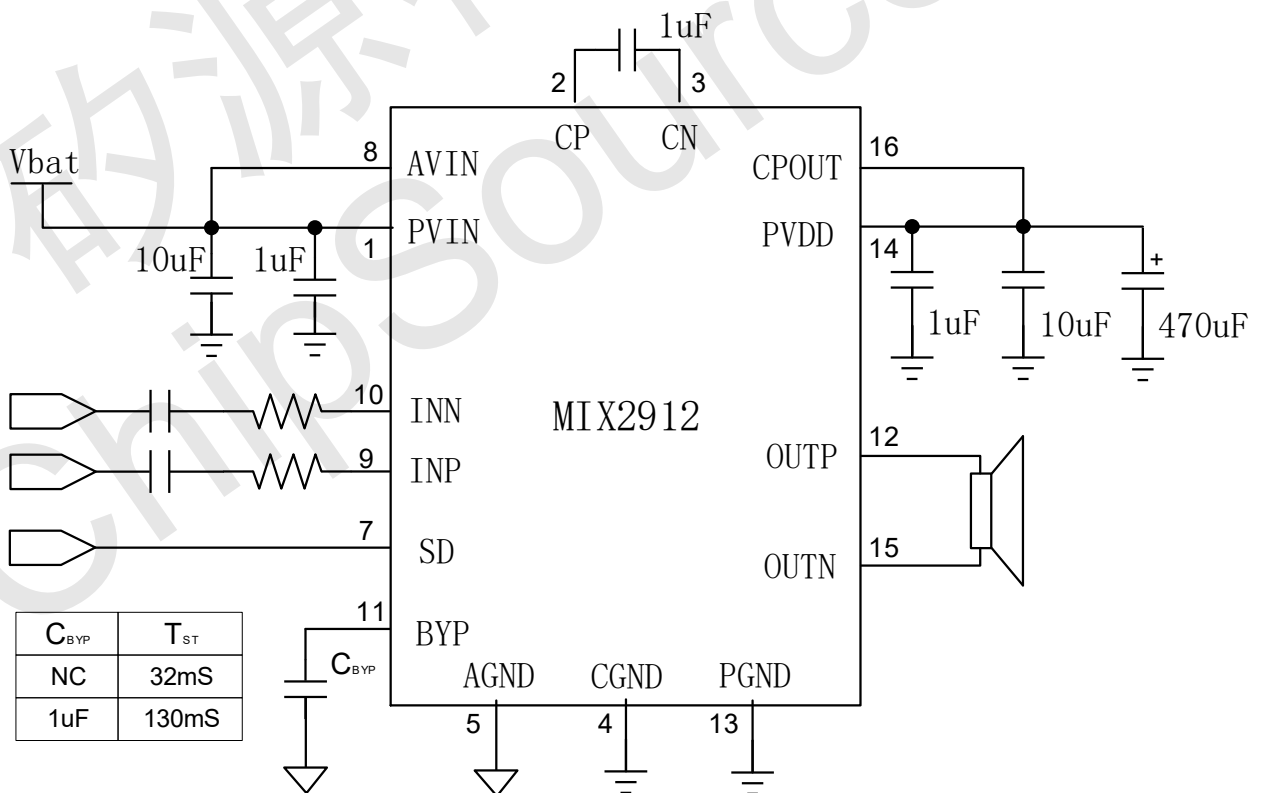



**MIX2912**

**5. 5W 单通道电荷泵升压防破音 F 类功放**

引脚排列

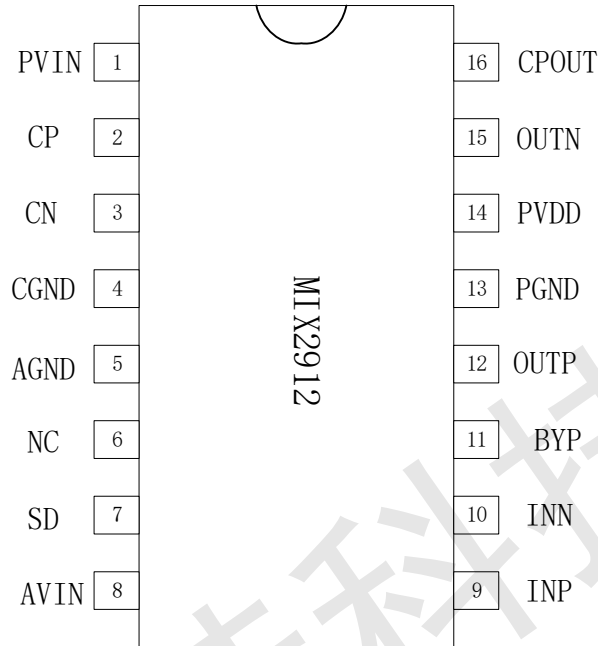

管脚描述

管脚	符号	I/O	描述
1	PVIN	I	电荷泵功率电源
2	CP	I/O	电荷泵电容
3	CN	I/O	电荷泵电容
4	CGND		电荷泵功率地线
5	AGND		音频模拟地线
6	NC		空脚
7	SD	I	使能管脚（带一线脉冲控制模式切换）
8	AVIN		音频模拟电源
9	INP	I	音频正输入端
10	INN	I	音频负输入端
11	BYP	I/O	旁路管脚（悬空则功放快速启动）
12	OUTP	O	音频正输出端
13	PGND		音频功率地线
14	PVDD		音频功率电源
15	OUTN	O	音频负输出端
16	CPOUT	O	电荷泵升压输出



**MIX2912**

**5. 5W 单通道电荷泵升压防破音 F 类功放**

订货信息

料号	封装	表面印字	包装
MIX2912	ESOP16	MIX2912 XXXXXXX	2500 颗/卷

绝对最大额定值

PVIN,AVIN	供电电压	-0.3V to 5.5V
Vi	输入电压	-0.3V to PVIN+0.3V
TA	工作温度	-40°C to 85°C
TJ	结温	-40°C to 125°C
TSTG	储存温度	-65°C to 150°C
TSLD	焊接温度	300°C, 5sec

推荐额定值

			MIN	MAX	UNIT
PVIN,AVIN	供电电压		2.5	4.5	V
VIH	SD 高电平	AVIN=3.6V	1.6		V
VIL	SD 低电平	AVIN=4.5V		0.6	V
RL	负载交流阻抗 (@1KHz)	AVIN=2.5 - 4.5V	3		Ω

热阻参数

Parameter	Symbol	Package	MAX	UNIT
热阻(Junction to Ambient)	$\theta_{JA}$	ESOP16	85	°C/W
热阻(Junction to Case)	$\theta_{Jc}$	ESOP16	11	°C/W



**MIX2912**

**5. 5W 单通道电荷泵升压防破音 F 类功放**

**Charge-Pump Module and D MODE Electrical Characteristics**

(AVIN = PVIN = 3.6V, Gain=23.5dB, RL =4Ω, T =25°C, unless otherwise noted.)

Symbol	Parameter	Test Conditions		MIN	TYP	MAX	UNIT
AVIN	Supply Voltage			2.5	-	4.5	V
Po	Output Power	THD+N=10%,f=1KHZ,RL=3Ω NCN OFF	PVIN=4.2V		5.5		W
			PVIN=3.6V		4.5		
		THD+N=10%,f=1KHZ,RL=4Ω NCN OFF	PVIN=4.2V		4.6		W
			PVIN=3.6V		4.0		
		THD+N=1%, f=1KHZ,RL=3Ω NCN OFF	PVIN=4.2V		4.0		W
			PVIN=3.6V		3.9		
		THD+N=1%, f=1KHZ,RL=4Ω NCN OFF	PVIN=4.2V		3.9		W
			PVIN=3.6V		3.6		
PVIN=3.6V - 4.2V, F=1KHZ, RL=3Ω, THD+N < 1%	ACF1		3		W		
		ACF2	2.9				
PVIN=3.6V - 4.2V, F=1KHZ, RL=4Ω, THD+N < 1%	ACF1		2.6		W		
		ACF2	2.5				
THD+N	Total Harmonic Distortion Plus Noise	PVIN=4.2V, Po=2W, RL=4 Ω PVIN=3.6V, Po=1W, RL=4 Ω	f=1KHz		0.2		%
					0.2		
Gv	Gain		Ri = 33K		23.5		dB
PSRR	Power Supply Ripple Rejection	AVIN=3.6V ± 200mVp-p	f=1KHz		60		dB
SNR	Signal-to-Noise Ratio	AVIN=3.6V, Vo rms=1V, Gv=20dB	f=1KHz		86		dB
Vn	Output Noise	AVIN=3.6V,Input floating with CIN=0.1μF	A-weighting		100		μV
			No A-weighting		150		
Dyn	Dynamic Range	AVIN=3.6V,THD=1%	f=1KHz		90		dB
Iq	Quiescent Current	AVIN=4.2V	No Load		3		mA
		AVIN=3.0V	CP off		2.5		
I <sub>SD</sub>	Shutdown Current	AVIN=2.5V to 4.5V	V <sub>SD</sub> =0V			10	μA
Fosc	Oscillator Frequency				285		khz
Tst	Setup Time	Bypass capacitor =1uF			130		mS
		Bypass capacitor = NC			32		
OTP	—	No Load, Junction Temperature	AVIN=3.6V		180		°C
OTH	—				40		



**MIX2912**

5. 5W 单通道电荷泵升压防破音 F 类功放

## Charge-Pump Module Electrical Characteristics

(AVIN = PVIN = 3.6V, Gain=23.5dB, R<sub>L</sub> =4Ω, T =25°C, unless otherwise noted.)

Charge Pump Electrical Characteristics						
Symbol	Parameter	Test Conditions	MIN	TYP	MAX	UNIT
PVIN	Supply Voltage		2.5		4.5	V
Fsw	CP Frequency	PVIN=3.6V		2400		kHz
Tss	CP softstart time	PVIN=3.6V		500		uS

矽源特科技  
ChipSourceTek



### Typical Operating Characteristics

(AVIN = PVIN = 3.6V, Gain=23.5dB, RL =4Ω, T =25°C, unless otherwise noted.)

THD+N vs Output Power

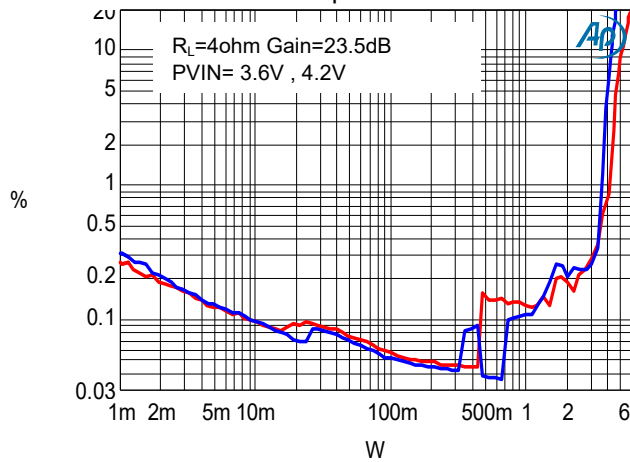

THD+N vs Output Power

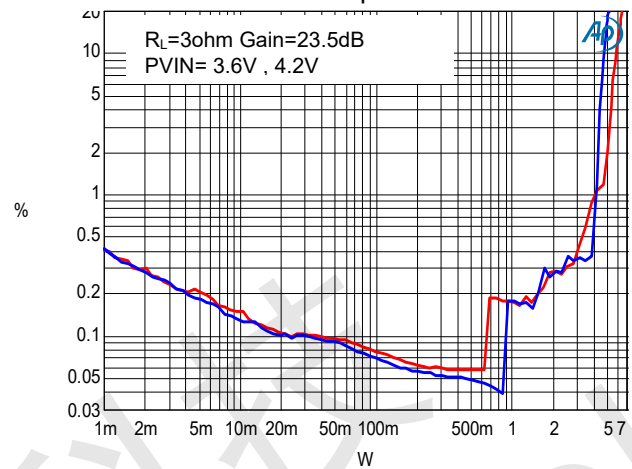

THD+N VS FREQUENCY

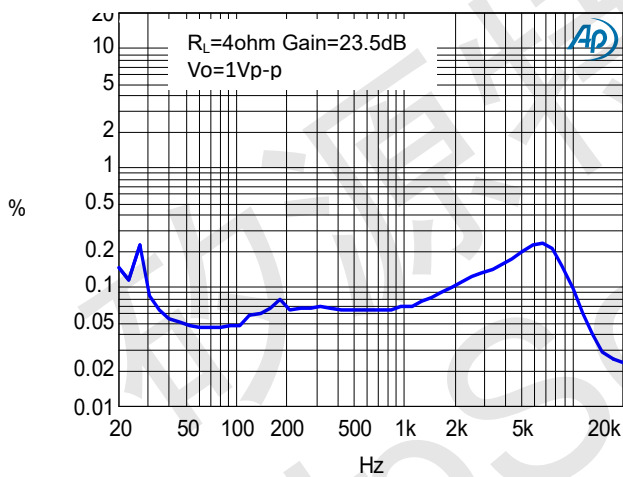

PSRR

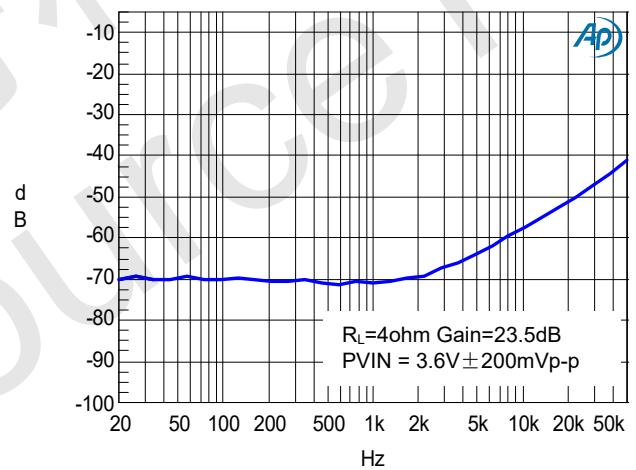

Noise Floor

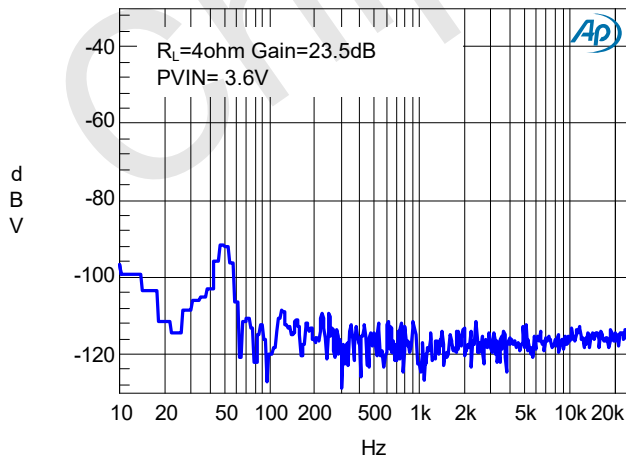

Frequency Response

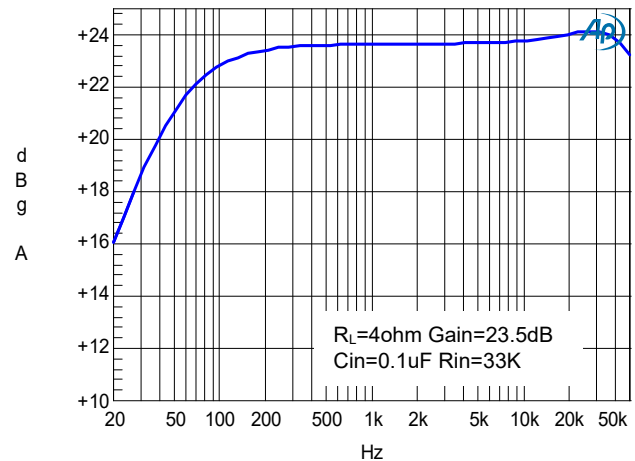



## F Mode Electrical Characteristics

(AVIN = PVIN = 3.6V, Gain=23.5dB, RL =4Ω, T =25°C, unless otherwise noted.)

Symbol	Parameter	Test Conditions	MIN	TYP	MAX	UNIT
AVIN	Supply Voltage		2.5	-	4.5	V
Po	Output Power	THD+N=10%, f=1KHZ, RL=3Ω	PVIN=4.2V	2.6		W
			PVIN=3.6V	1.9		
		THD+N=1%, f=1KHZ, RL=3Ω	PVIN=4.2V	2.1		W
			PVIN=3.6V	1.5		
Po	Output Power	THD+N=10%, f=1KHZ, RL=4Ω	PVIN=4.2V	2.2		W
			PVIN=3.6V	1.6		
		THD+N=1%, f=1KHZ, RL=4Ω	PVIN=4.2V	1.8		W
			PVIN=3.6V	1.3		
THD+N	Total Harmonic Distortion Plus Noise	PVIN=4.2V, Po=1W, RL=4 Ω	f=1KHz	0.1		%
		PVIN=3.6V, Po=0.5W, RL=4 Ω		0.1		
Gv	Gain	Ri = 33K		23.5		dB
PSRR	Power Supply Ripple Rejection	PVIN=3.6V±200mVp-p	f=1KHz	60		dB
SNR	Signal-to-Noise Ratio	AVIN=3.6V, Vo rms=1V, Gv=20dB	f=1KHz	86		dB
Vn	Output Noise	AVIN=3.6V, Input floating with CIN=0.1μF	A-weighting	100		μV
			No A-weighting	150		
Dyn	Dynamic Range	AVIN=3.6V, THD=1%	f=1KHz	90		dB
Iq	Quiescent Current	AVIN=4.2V	No Load	15		mA
		AVIN=3.0V	CP off	10		
I <sub>SD</sub>	Shutdown Current	AVIN=2.5V to 4.5V	V <sub>SD</sub> =0V		10	μA
Vos	Offset Voltage	AVIN=3.6V		10		mV



### Typical Operating Characteristics

(AVIN = PVIN = 3.6V, Gain=23.5dB, RL =4Ω, T =25°C, unless otherwise noted.)

THD+N vs Output Power

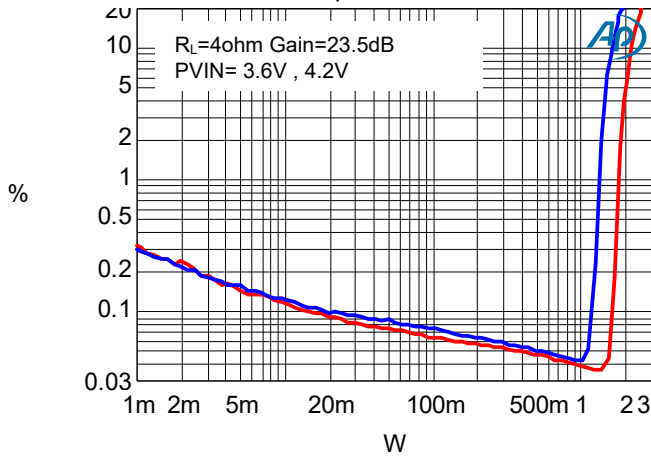

THD+N vs Output Power

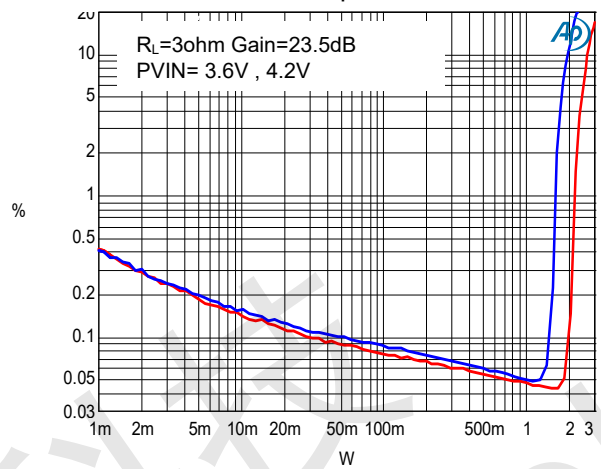

THD+N VS FREQUENCY

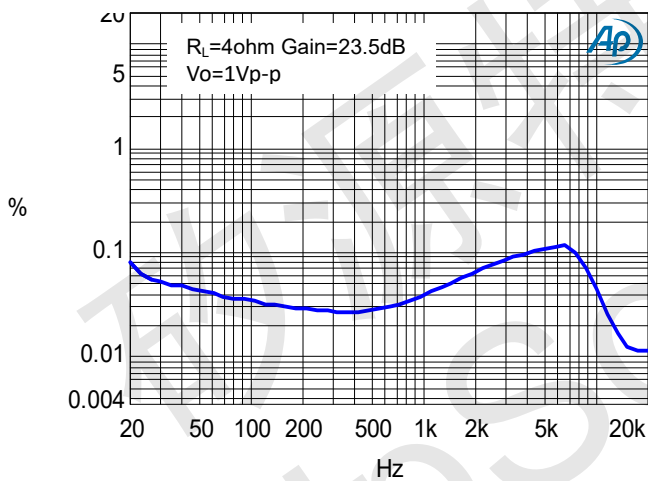

PSRR

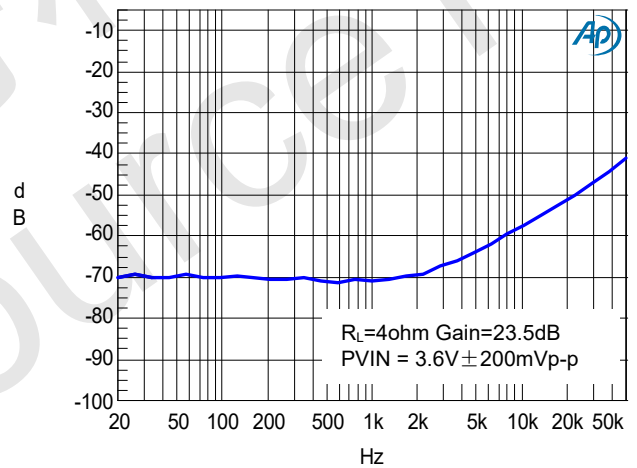

Noise Floor

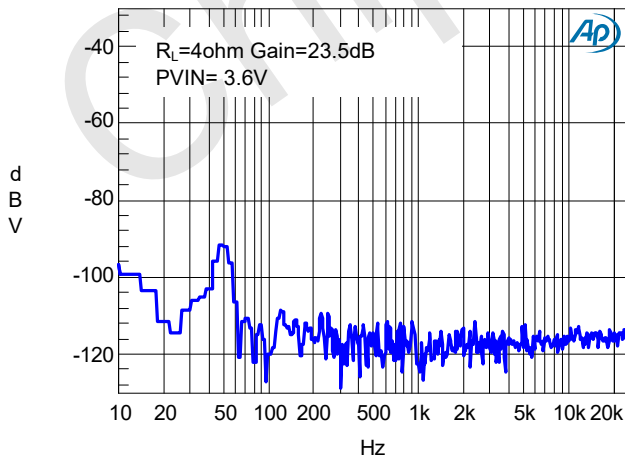

Frequency Response

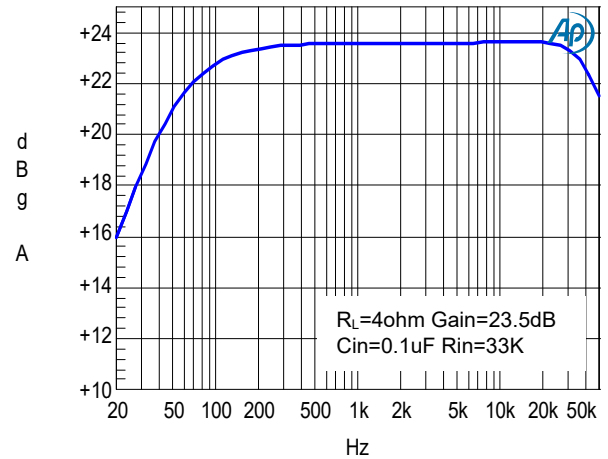





## 应用信息

### 输入电阻(Ri)

MIX2912的增益由音量调节控制的输入电阻(Ri)和反馈电阻(Rf)控制。有如下的增益计算公式：

$$A_v = 2 \times \frac{R_f}{R_i} \left( \frac{V}{V} \right)$$

其中， Ri为芯片外部的可调节输入电阻；反馈电阻Rf为250K（反馈电阻为内部固定，不可外部调节）。

例如，外部输入电阻为33K，则放大倍数为：

$$A_v = 2 \times 250 / (33) = 15.1 \text{ 倍} = 23.5 \text{ dB}$$

### 输入电容 (Ci)

输入电容与输入电阻构成一个高通滤波器，其截止频率可由下式得出：

$$f_c = \frac{1}{(2\pi R_i C_i)}$$

Ci的值不仅会影响到电路的低频响应，而且也会影响电路启动和关断时所产生的POP声，输入电容越大，则到达其稳定工作点所需的电荷越多，在同等条件下，小的输入电容所产生的POP声比较小。

### SD管脚和防破音 (NCN) 控制

SD管脚是功放的使能管脚。SD管脚为高电平时，功放正常工作，SD管脚为低电平时，功放关断。

芯片有四个工作状态，分别是D类防破音模式1，D类防破音模式2，D类防破音关闭，AB类防破音关闭。

当SD管脚直接拉高时，芯片默认工作在D类防破音模式1；当SD管脚直接拉低，芯片关闭。如果需要切换其它工作模式，需要通过SD管脚一线脉冲控制。

D类防破音模式1的输出音量比D类防破音模式2要大一些，但是失真同时也大一些。追求较低失真同时要求防破音功能，可以选择D类防破音模式2。如果追求较大的声音，则选择D类防破音模式1。

电荷泵升压部分是自适应的，当芯片需要较大的输出功率时，升压部分自动启动，提供能量。但音量减小

时，升压部分自动关闭，降低电源消耗，提高工作效率。

四个一线脉冲控制方式如下：

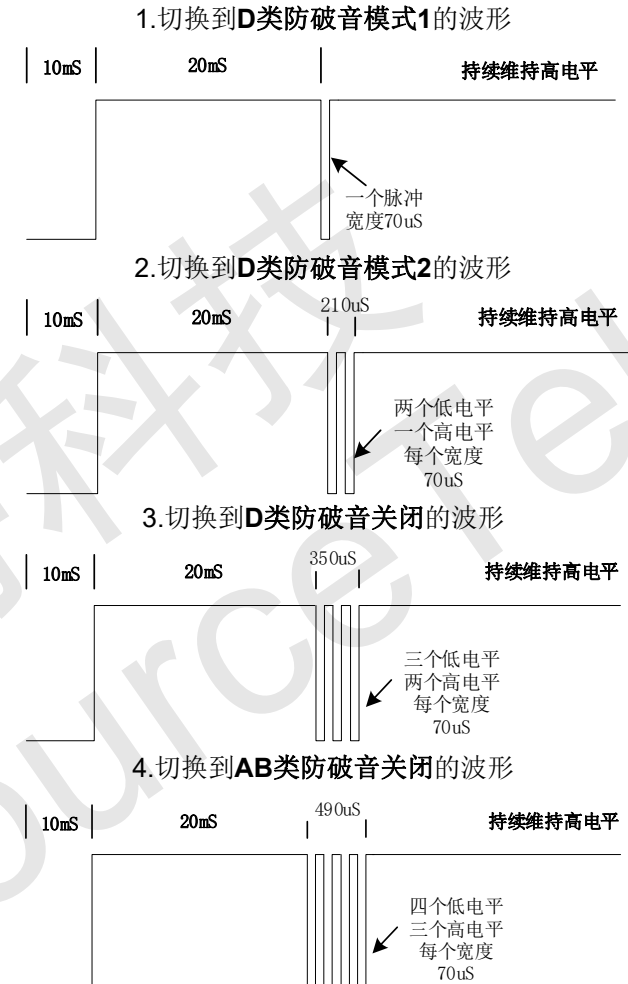

### 过温保护

MIX2912 带有过温保护电路以防止内部温度超过180℃时器件损坏。在不同器件之间，这个值有25℃的差异。当内部电路超过设置的保护温度时，器件进入关断状态，输出被截止。当温度下降 30℃后，器件重新正常工作。



## 应用信息

### 评估板PCB走线

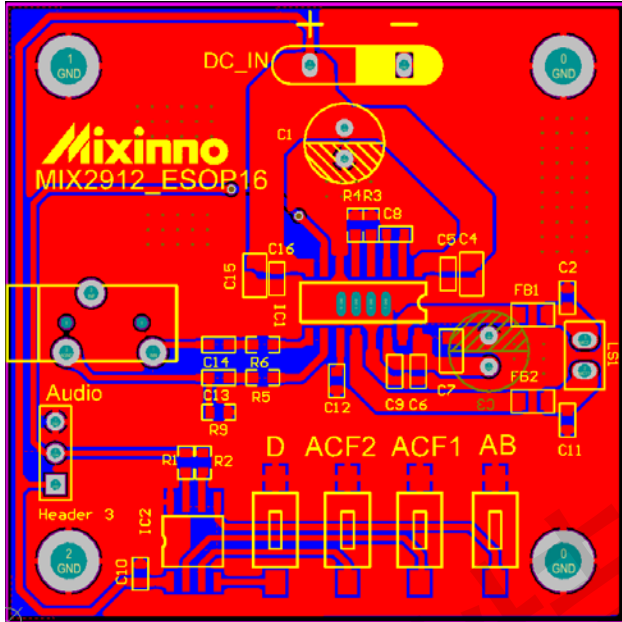

PVIN 是升压部分供电管脚，所以 PVIN 的耦合电容尽量靠近芯片管脚和功率地线 CGND。CPOUT 是升压输出管脚，PVDD 是功放供电管脚，这两个管脚的耦合电容也需要尽量靠近芯片管脚和功率地线 PGND。同时 PVDD 管脚上面需要对地连接电解电容，以获得较好的低频效果。为了较好 EMI 的效果，CP, CN 管脚走线尽量短，OUTP 和 OUTN 管脚尽量粗短，以降低 EMI 辐射。芯片的 AGND 是音频模拟地线，良好的地线分割，可以获得优异的噪声指标。。

# ESOP-16

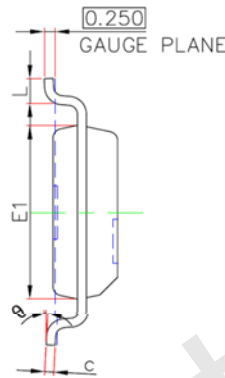
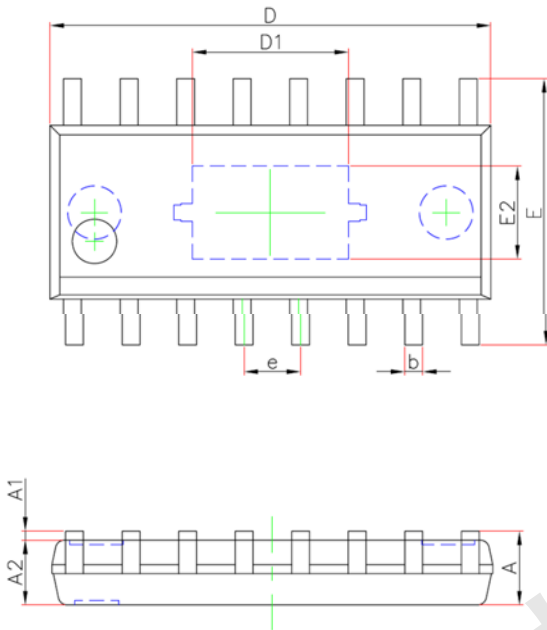

SYMBOL	Millimeter		
	MIN	NOM	MAX
A	-	-	1.75
A1	0.05	0.10	0.15
A2	1.30	1.40	1.50
b	0.33	0.41	0.48
c	0.17	0.20	0.25
D	9.80	9.90	10.10
E	5.80	6.00	6.20
E1	3.70	3.90	4.10
e	1.27BSC		
L	0.50	-	0.80
θ	0	-	8°
D1	4.57REF		
E2	2.41REF		

ChipSourceTek.com