

# MJE13005DQ7

Rev.E Mar.-2016

## 描述 / Descriptions

TO-220 塑封封装 NPN 半导体三极管。 Silicon NPN transistor in a TO-220 Plastic Package.

## 特征 / Features

耐压高,开关速度快。

High voltage capability, high speed switching.

## 用途 / Applications

用于高频电子照明电路、开关及开关电源。

High frequency electronic lighting, switching power supply applications .

## 内部等效电路 / Equivalent Circuit

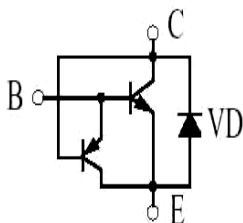

## 引脚排列 / Pinning

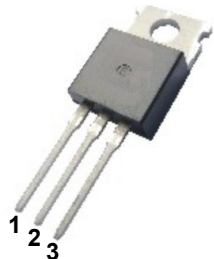

PIN1 : Base

PIN 2 : Collector

PIN 3 : Emitter

## 放大及印章代码 / $h_{FE}$ Classifications & Marking

见印章说明。 See Marking Instructions.

**极限参数 / Absolute Maximum Ratings(Ta=25°C)**

参数 Parameter	符号 Symbol	数值 Rating	单位 Unit
Collector to Base Voltage	$V_{CBO}$	700	V
Collector to Emitter Voltage	$V_{CEO}$	400	V
Emitter to Base Voltage	$V_{EBO}$	9.0	V
Collector Current - Continuous	$I_C$	4	A
Collector Power Dissipation	$P_C$	2.0	W
	$P_C(T_c=25^\circ\text{C})$	75	W
Junction Temperature	$T_j$	150	°C
Storage Temperature Range	$T_{stg}$	-55~150	°C

**电性能参数 / Electrical Characteristics(Ta=25°C)**

参数 Parameter	符号 Symbol	测试条件 Test Conditions	最小值 Min	典型值 Typ	最大值 Max	单位 Unit
Collector to Base Breakdown Voltage	$V_{CBO}$	$I_C=1\text{mA}$ $I_E=0$	700			V
Collector to Emitter Breakdown Voltage	$V_{CEO}$	$I_C=10\text{mA}$ $I_B=0$	400			V
Emitter to Base Breakdown Voltage	$V_{EBO}$	$I_E=1\text{mA}$ $I_C=0$	9.0			V
Emitter Base Cut-Off Current	$I_{CBO}$	$V_{CB}=700\text{V}$ $I_E=0$			0.1	mA
Collector Cut-Off Current	$I_{CEO}$	$V_{CE}=400\text{V}$ $I_B=0$			0.1	mA
Collector cut-off current	$I_{EBO}$	$V_{EB}=9.0\text{V}$ $I_C=0$			0.1	mA
DC Current Gain	$h_{FE(1)}$	$V_{CE}=5.0\text{V}$ $I_C=1.0\text{A}$	10		50	
	$h_{FE(2)}$	$V_{CE}=5.0\text{V}$ $I_C=2.0\text{A}$	8		40	
Collector to Emitter Saturation Voltage	$V_{CE(sat)}$	$I_C=2.0\text{A}$ $I_B=0.4\text{A}$			1.0	V
Base to Emitter Saturation Voltage	$V_{BE(sat)}$	$I_C=2.0\text{A}$ $I_B=0.4\text{A}$			1.6	V
Transition Frequency	$f_T$	$V_{CE}=10\text{V}$ $f=1.0\text{MHz}$ $I_C=0.5\text{A}$	5.0			MHz
Fall time	$t_f$	$V_{CE}=5\text{V}$ $I_C=0.5\text{A}$ (UI9600)			0.8	μs
Storage time	$t_s$				4.0	μs

电参数曲线图 / Electrical Characteristic Curve

SOA(DC)

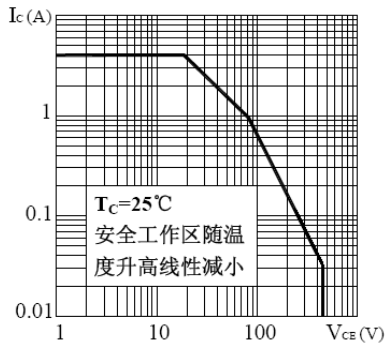

Pc-Tc

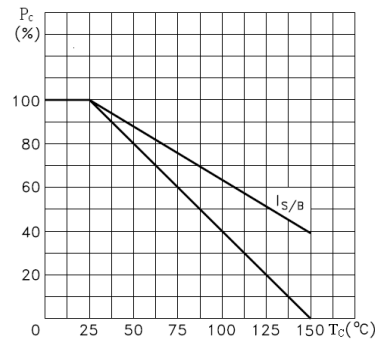

hFE-Ic

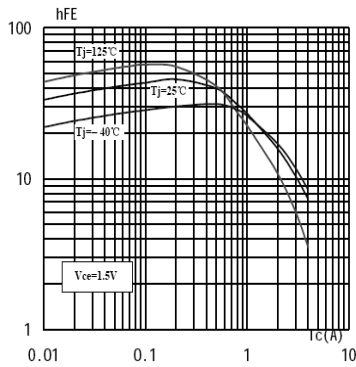

hFE-Ic

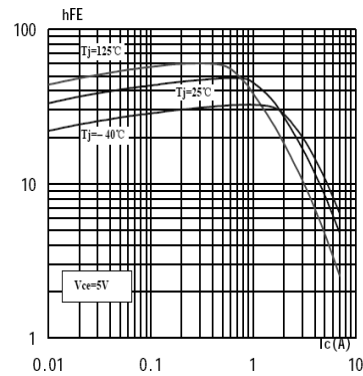

Vces-Ic

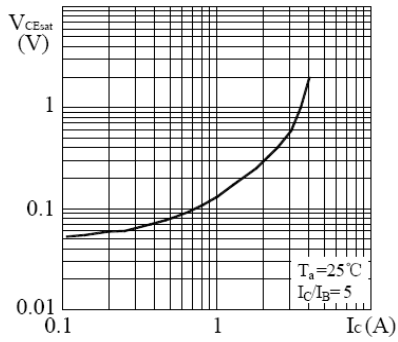

Vbes-Ic

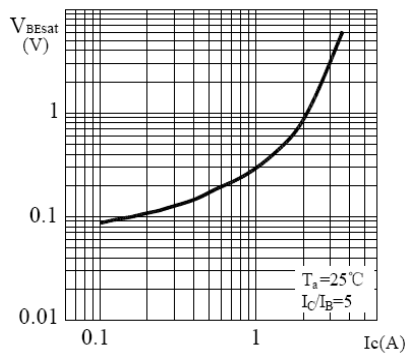

ts-Ta

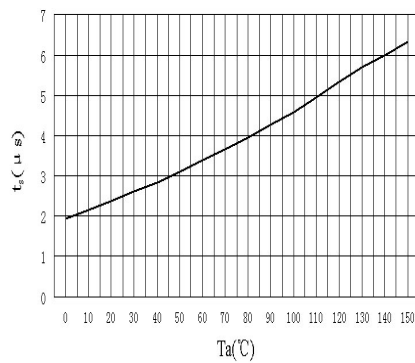

hFE-Ta

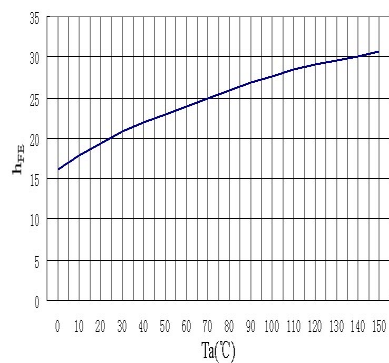

外形尺寸图 / Package Dimensions

TO-220

单位: mm

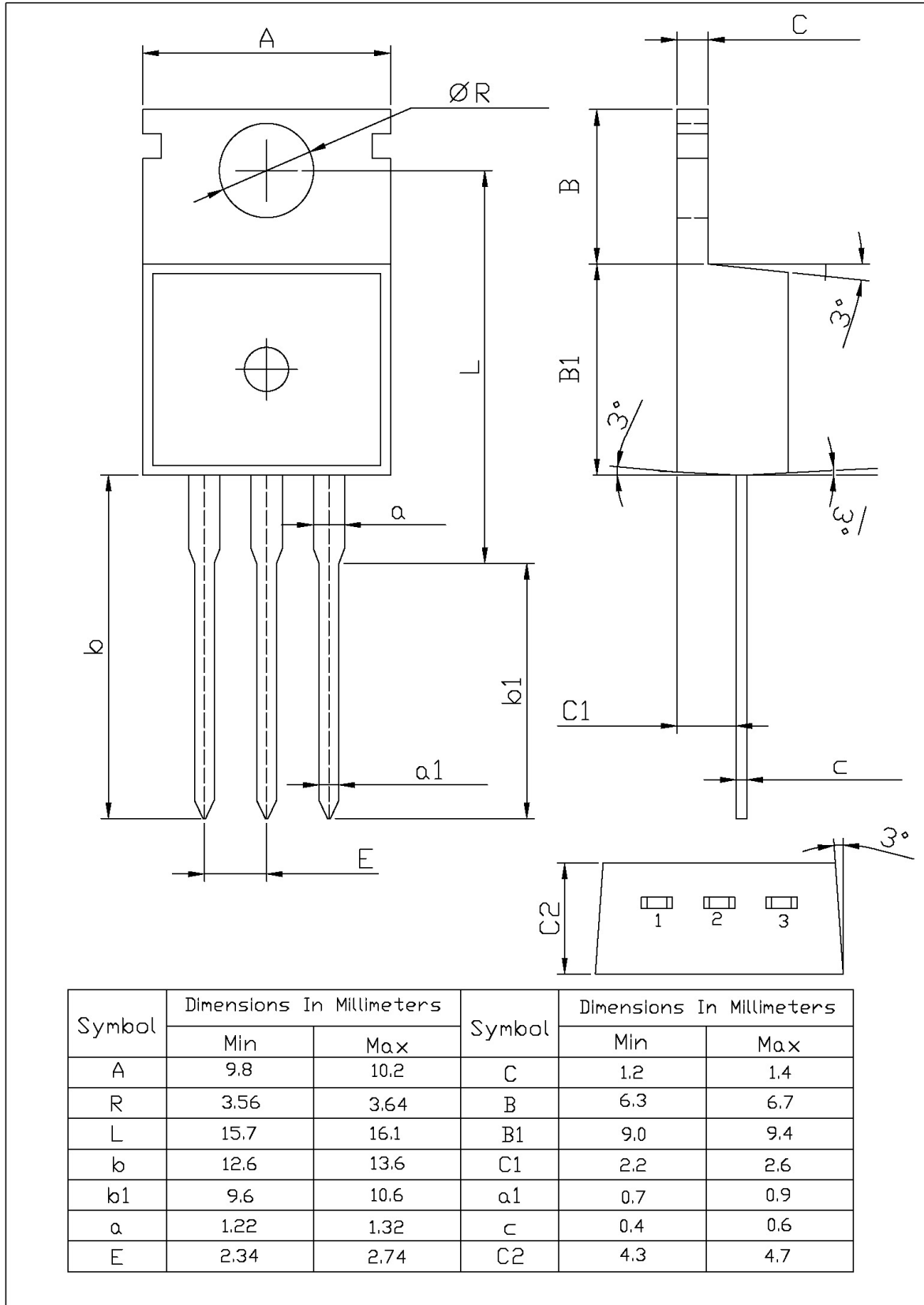

印章说明 / Marking Instructions

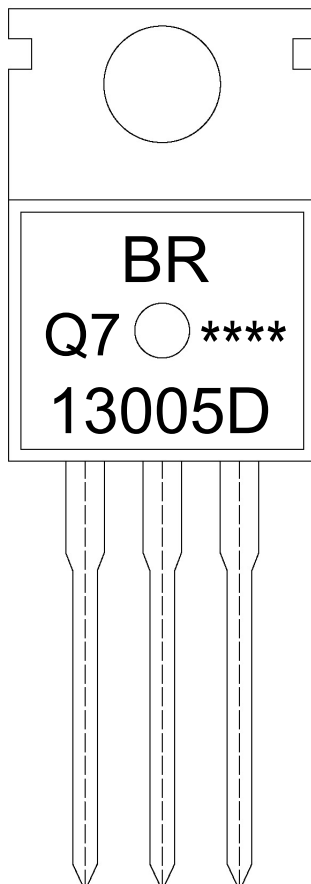

说明：

BR： 为公司代码

13005D： 为型号代码

Q7: 为规格代码

\*\*\*\*： 为生产批号代码，随生产批号变化。

Note:

BR: Company Code

13005D： Product Type.

Q7: Specification Code

\*\*\*\*: Lot No. Code, code change with Lot No.

**波峰焊温度曲线图(无铅) / Temperature Profile for Dip Soldering(Pb-Free)**



说明：

- 1、预热温度 25 ~ 150°C，时间 60 ~ 90sec;
- 2、峰值温度 255±5°C，时间持续为 5±0.5sec;
- 3、焊接制程冷却速度为 2 ~ 10°C/sec.

Note:

- 1.Preheating:25~150°C, Time:60~90sec.
- 2.Peak Temp.:255±5°C, Duration:5±0.5sec.
3. Cooling Speed: 2~10°C/sec.

**耐焊接热试验条件 / Resistance to Soldering Heat Test Conditions**

温度：270±5°C

时间：10±1 sec.

Temp.:270±5°C

Time:10±1 sec

**包装规格 / Packaging SPEC.**

散件包装 / BULK

Package Type 封装形式	Units 包装数量					Dimension 包装尺寸 (unit: mm <sup>3</sup> )		
	Units/Bag 只/袋	Bags/Inner Box 袋/盒	Units/Inner Box 只/盒	Inner Boxes/Outer Box 盒/箱	Units/Outer Box 只/箱	Bag 袋	Inner Box 盒	Outer Box 箱
TO-220/F	200	10	2,000	5	10,000	135×190	237×172×102	560×245×195

套管包装 / TUBE

Package Type 封装形式	Units 包装数量					Dimension 包装尺寸 (unit: mm <sup>3</sup> )		
	Units/Tube 只/套管	Tubes/Inner Box 套管/盒	Units/Inner Box 只/盒	Inner Boxes/Outer Box 盒/箱	Units/Outer Box 只/箱	Tube 套管	Inner Box 盒	Outer Box 箱
TO-220/F	50	20	1,000	5	5,000	532×31.4×5.5	555×164×50	575×290×180

**使用说明 / Notices**