

MJE13005LP7

Rev.E Mar.-2016

描述 / Descriptions

TO-220 塑封封装 NPN 半导体三极管。Silicon NPN transistor in a TO-220 Plastic Package.

特征 / Features

耐压高,开关速度快。

High voltage capability, high speed switching.

用途 / Applications

用于高频电子照明电路、开关及开关电源。

High frequency electronic lighting, switching power supply applications .

内部等效电路 / Equivalent Circuit

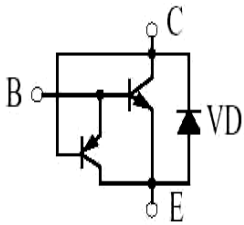

引脚排列 / Pinning

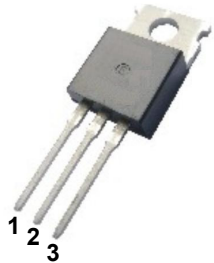

PIN1 : Base

PIN 2 : Collector

PIN 3 : Emitter

放大及印章代码 / h_{FE} Classifications & Marking

见印章说明。See Marking Instructions.

极限参数 / Absolute Maximum Ratings(Ta=25°C)

参数 Parameter	符号 Symbol	数值 Rating	单位 Unit
Collector to Base Voltage	V_{CBO}	400	V
Collector to Emitter Voltage	V_{CEO}	200	V
Emitter to Base Voltage	V_{EBO}	9.0	V
Collector Current - Continuous	I_C	6.0	A
Collector Power Dissipation	P_C	2.0	W
Collector Power Dissipation	$P_C(T_c=25^\circ\text{C})$	60	W
Junction Temperature	T_j	150	°C
Storage Temperature Range	T_{stg}	-55~150	°C

电性能参数 / Electrical Characteristics(Ta=25°C)

参数 Parameter	符号 Symbol	测试条件 Test Conditions	最小值 Min	典型值 Typ	最大值 Max	单位 Unit
Collector to Base Breakdown Voltage	V_{CBO}	$I_C=1\text{mA}$ $I_E=0$	400			V
Collector to Emitter Breakdown Voltage	V_{CEO}	$I_C=10\text{mA}$ $I_B=0$	200			V
Emitter to Base Breakdown Voltage	V_{EBO}	$I_E=1\text{mA}$ $I_C=0$	9.0			V
Base Cut-Off Current	I_{CBO}	$V_{CB}=400\text{V}$ $I_E=0$			0.1	mA
Collector Cut-Off Current	I_{CEO}	$V_{CE}=200\text{V}$ $I_B=0$			0.1	mA
Emitter Base Cut-Off Current	I_{EBO}	$V_{EB}=9.0\text{V}$ $I_C=0$			0.1	mA
DC Current Gain	h_{FE}	$V_{CE}=5.0\text{V}$ $I_C=0.5\text{A}$	10		40	
Collector to Emitter Saturation Voltage	$V_{CE(sat)}$	$I_C=2.0\text{A}$ $I_B=0.5\text{A}$			0.6	V
Base to Emitter Saturation Voltage	$V_{BE(sat)}$	$I_C=2.0\text{A}$ $I_B=0.5\text{A}$			1.2	V
Transition Frequency	f_T	$V_{CE}=10\text{V}$ $f=1.0\text{MHz}$ $I_C=0.5\text{A}$	4.0			MHz
Fall time	t_f	$V_{CE}=5\text{V}$ $I_C=0.5\text{A}$ (UI9600)			0.6	μs
Storage time	t_s				4.0	μs

电参数曲线图 / Electrical Characteristic Curve

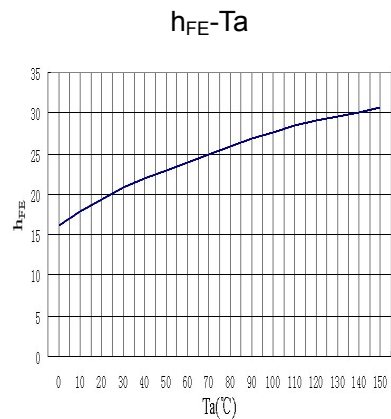
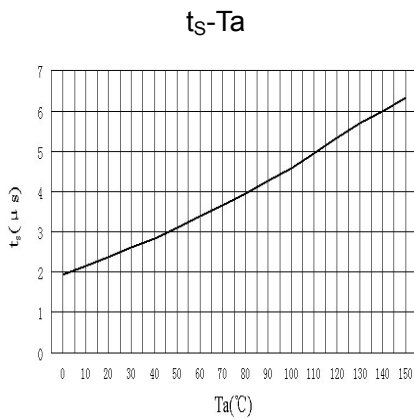
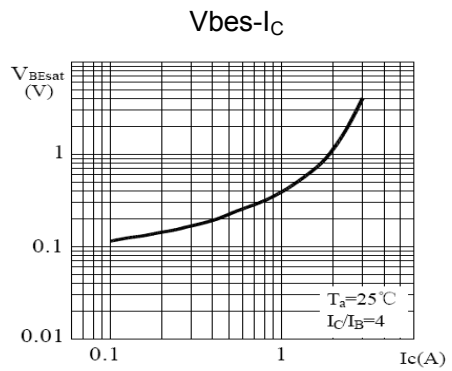
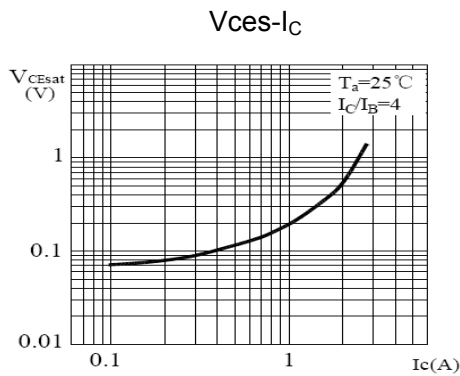
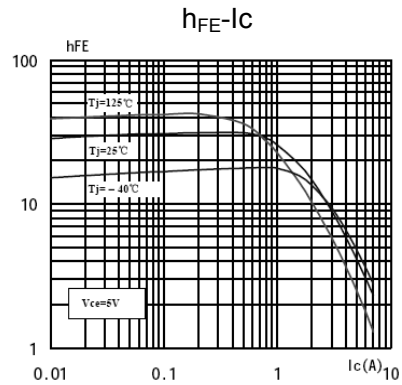
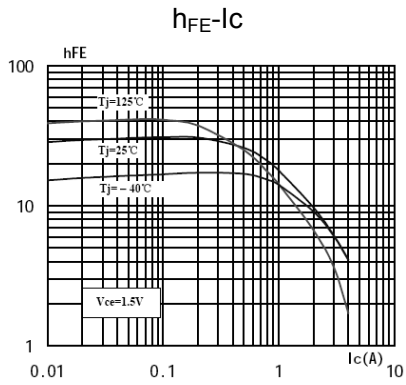
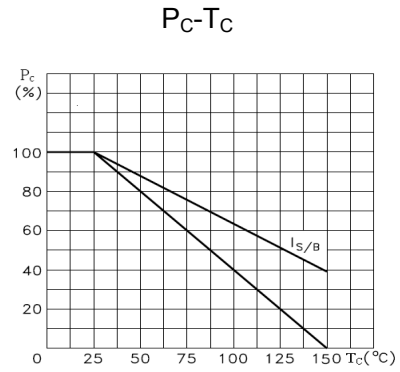
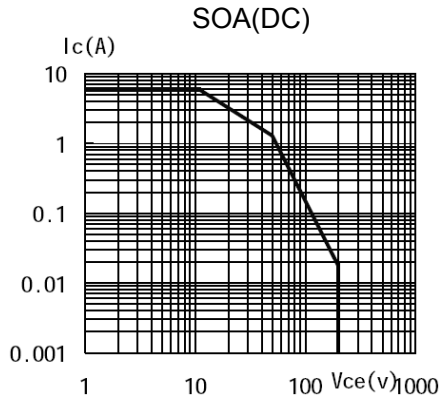

外形尺寸图 / Package Dimensions

TO-220

单位: mm

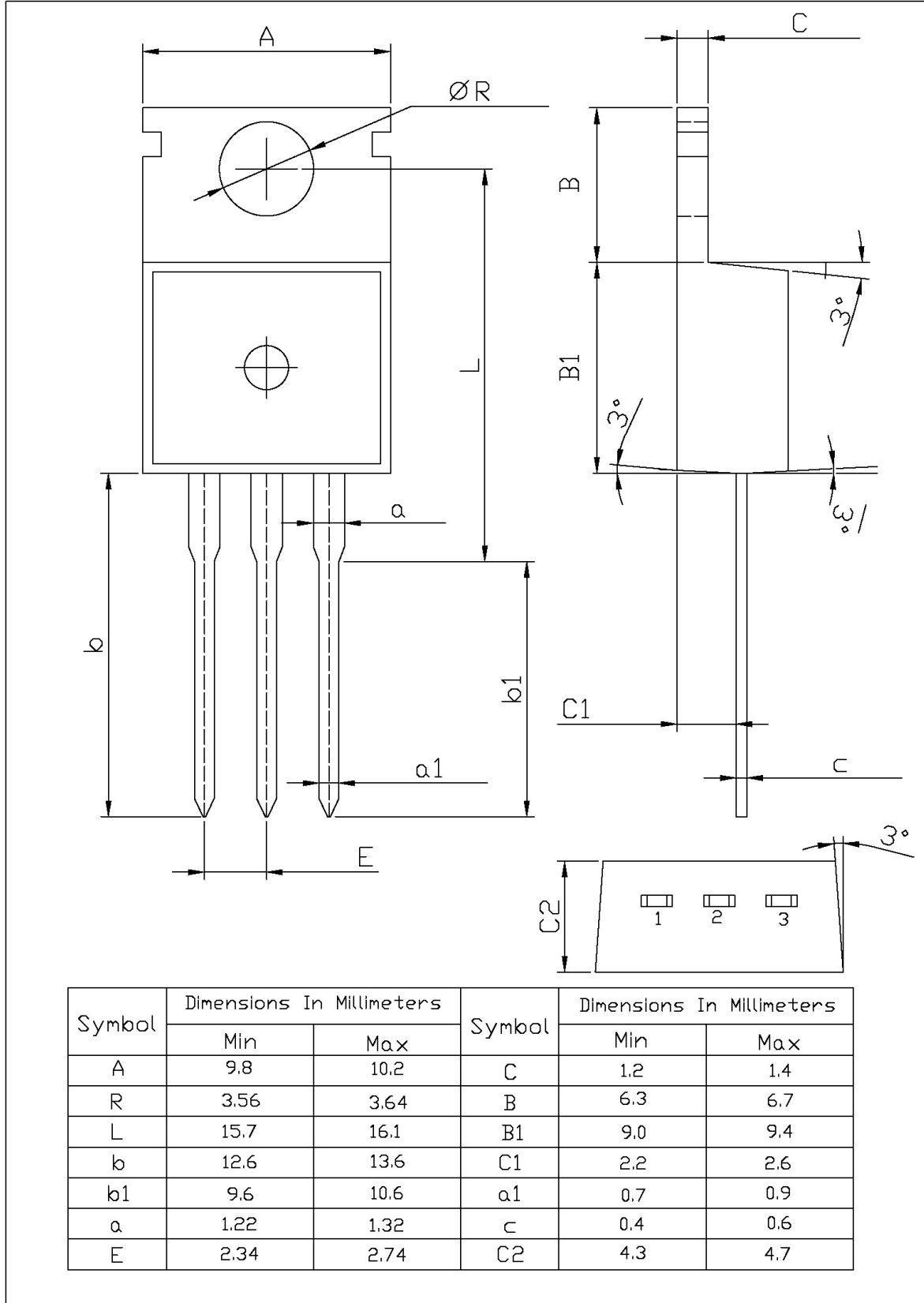

印章说明 / Marking Instructions

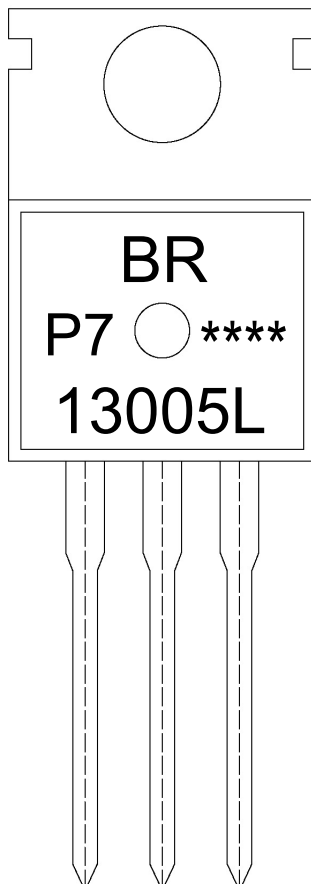

说明：

BR： 为公司代码

13005L： 为型号代码

P7： 为规格代码

****： 为生产批号代码，随生产批号变化。

Note:

BR: Company Code

13005L : Product Type.

P7: Specification Code

****: Lot No. Code, code change with Lot No.

波峰焊温度曲线图(无铅) / Temperature Profile for Dip Soldering(Pb-Free)



说明：

- 1、预热温度 25 ~ 150°C，时间 60 ~ 90sec;
- 2、峰值温度 255±5°C，时间持续为 5±0.5sec;
- 3、焊接制程冷却速度为 2 ~ 10°C/sec.

Note:

- 1.Preheating:25~150°C, Time:60~90sec.
- 2.Peak Temp.:255±5°C, Duration:5±0.5sec.
3. Cooling Speed: 2~10°C/sec.

耐焊接热试验条件 / Resistance to Soldering Heat Test Conditions

温度：270±5°C

时间：10±1 sec.

Temp.:270±5°C

Time:10±1 sec

包装规格 / Packaging SPEC.

散件包装 / BULK

Package Type 封装形式	Units 包装数量					Dimension 包装尺寸 (unit: mm ³)		
	Units/Bag 只/袋	Bags/Inner Box 袋/盒	Units/Inner Box 只/盒	Inner Boxes/Outer Box 盒/箱	Units/Outer Box 只/箱	Bag 袋	Inner Box 盒	Outer Box 箱
TO-220/F	200	10	2,000	5	10,000	135×190	237×172×102	560×245×195

套管包装 / TUBE

Package Type 封装形式	Units 包装数量					Dimension 包装尺寸 (unit: mm ³)		
	Units/Tube 只/套管	Tubes/Inner Box 套管/盒	Units/Inner Box 只/盒	Inner Boxes/Outer Box 盒/箱	Units/Outer Box 只/箱	Tube 套管	Inner Box 盒	Outer Box 箱
TO-220/F	50	20	1,000	5	5,000	532×31.4×5.5	555×164×50	575×290×180

使用说明 / Notices