

# MJE700, MJE702, MJE703 (PNP) - MJE800, MJE802, MJE803 (NPN)

## Plastic Darlington Complementary Silicon Power Transistors

These devices are designed for general-purpose amplifier and low-speed switching applications.

### Features

- High DC Current Gain –  $h_{FE} = 2000$  (Typ) @  $I_C = 2.0$  Adc
- Monolithic Construction with Built-in Base-Emitter Resistors to Limit Leakage – Multiplication
- Choice of Packages – MJE700 and MJE800 Series
- Pb-Free Packages are Available\*

### MAXIMUM RATINGS

Rating	Symbol	Value	Unit
Collector-Emitter Voltage MJE700, MJE800 MJE702, MJE703, MJE802, MJE803	$V_{CEO}$	60 80	Vdc
Collector-Base Voltage MJE700, MJE800 MJE702, MJE703, MJE802, MJE803	$V_{CB}$	60 80	Vdc
Emitter-Base Voltage	$V_{EB}$	5.0	Vdc
Collector Current	$I_C$	4.0	Adc
Base Current	$I_B$	0.1	Adc
Total Power Dissipation @ $T_C = 25^\circ\text{C}$ Derate above $25^\circ\text{C}$	$P_D$	40 0.32	W mW/ $^\circ\text{C}$
Operating and Storage Junction Temperature Range	$T_J, T_{stg}$	-55 to +150	$^\circ\text{C}$

### THERMAL CHARACTERISTICS

Characteristic	Symbol	Max	Unit
Thermal Resistance, Junction-to-Case	$\theta_{JC}$	6.25	$^\circ\text{C}/\text{W}$

Maximum ratings are those values beyond which device damage can occur. Maximum ratings applied to the device are individual stress limit values (not normal operating conditions) and are not valid simultaneously. If these limits are exceeded, device functional operation is not implied, damage may occur and reliability may be affected.

\*For additional information on our Pb-Free strategy and soldering details, please download the ON Semiconductor Soldering and Mounting Techniques Reference Manual, SOLDERRM/D.



ON Semiconductor®

<http://onsemi.com>

**4.0 AMPERE  
DARLINGTON POWER  
TRANSISTORS  
COMPLEMENTARY SILICON  
40 WATT  
50 WATT**

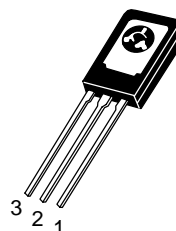

TO-225  
CASE 77  
STYLE 1

### MARKING DIAGRAM

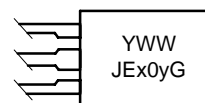

Y = Year  
 WW = Work Week  
 JEx0y = Device Code  
 x = 7 or 8  
 y = 0, 2, or 3  
 G = Pb-Free Package

### ORDERING INFORMATION

See detailed ordering and shipping information in the package dimensions section on page 5 of this data sheet.

# MJE700, MJE702, MJE703 (PNP) – MJE800, MJE802, MJE803 (NPN)

## ELECTRICAL CHARACTERISTICS (T<sub>C</sub> = 25°C unless otherwise noted)

Characteristic	Symbol	Min	Max	Unit	
<b>OFF CHARACTERISTICS</b>					
Collector–Emitter Breakdown Voltage (Note 1) (I <sub>C</sub> = 50 mA <sub>dc</sub> , I <sub>B</sub> = 0)	MJE700, MJE800 MJE702, MJE703, MJE802, MJE803	V <sub>(BR)CEO</sub>	60 80	– –	V <sub>dc</sub>
Collector Cutoff Current (V <sub>CE</sub> = 60 V <sub>dc</sub> , I <sub>B</sub> = 0) (V <sub>CE</sub> = 80 V <sub>dc</sub> , I <sub>B</sub> = 0)	MJE700, MJE800 MJE702, MJE703, MJE802, MJE803	I <sub>CEO</sub>	– –	100 100	μA <sub>dc</sub>
Collector Cutoff Current (V <sub>CB</sub> = Rated BV <sub>CEO</sub> , I <sub>E</sub> = 0) (V <sub>CB</sub> = Rated BV <sub>CEO</sub> , I <sub>E</sub> = 0, T <sub>C</sub> = 100°C)		I <sub>CBO</sub>	– –	100 500	μA <sub>dc</sub>
Emitter Cutoff Current (V <sub>BE</sub> = 5.0 V <sub>dc</sub> , I <sub>C</sub> = 0)		I <sub>EBO</sub>	–	2.0	mA <sub>dc</sub>

## ON CHARACTERISTICS

DC Current Gain (Note 1) (I <sub>C</sub> = 1.5 A <sub>dc</sub> , V <sub>CE</sub> = 3.0 V <sub>dc</sub> ) (I <sub>C</sub> = 2.0 A <sub>dc</sub> , V <sub>CE</sub> = 3.0 V <sub>dc</sub> ) (I <sub>C</sub> = 4.0 A <sub>dc</sub> , V <sub>CE</sub> = 3.0 V <sub>dc</sub> )	MJE700, MJE702, MJE800, MJE802 MJE703, MJE803 All devices	h <sub>FE</sub>	750 750 100	– – –	–
Collector–Emitter Saturation Voltage (Note 1) (I <sub>C</sub> = 1.5 A <sub>dc</sub> , I <sub>B</sub> = 30 mA <sub>dc</sub> ) (I <sub>C</sub> = 2.0 A <sub>dc</sub> , I <sub>B</sub> = 40 mA <sub>dc</sub> ) (I <sub>C</sub> = 4.0 A <sub>dc</sub> , I <sub>B</sub> = 40 mA <sub>dc</sub> )	MJE700, MJE702, MJE800, MJE802 MJE703, MJE803 All devices	V <sub>CE(sat)</sub>	– – –	2.5 2.8 3.0	V <sub>dc</sub>
Base–Emitter On Voltage (Note 1) (I <sub>C</sub> = 1.5 A <sub>dc</sub> , V <sub>CE</sub> = 3.0 V <sub>dc</sub> ) (I <sub>C</sub> = 2.0 A <sub>dc</sub> , V <sub>CE</sub> = 3.0 V <sub>dc</sub> ) (I <sub>C</sub> = 4.0 A <sub>dc</sub> , V <sub>CE</sub> = 3.0 V <sub>dc</sub> )	MJE700, MJE702, MJE800, MJE802 MJE703, MJE803 All devices	V <sub>BE(on)</sub>	– – –	2.5 2.5 3.0	V <sub>dc</sub>

## DYNAMIC CHARACTERISTICS

Small–Signal Current Gain (I <sub>C</sub> = 1.5 A <sub>dc</sub> , V <sub>CE</sub> = 3.0 V <sub>dc</sub> , f = 1.0 MHz)		h <sub>fe</sub>	1.0	–	–
---	--	-----------------	-----	---	---

1. Pulse Test: Pulse Width ≤ 300 μs, Duty Cycle ≤ 2.0%.

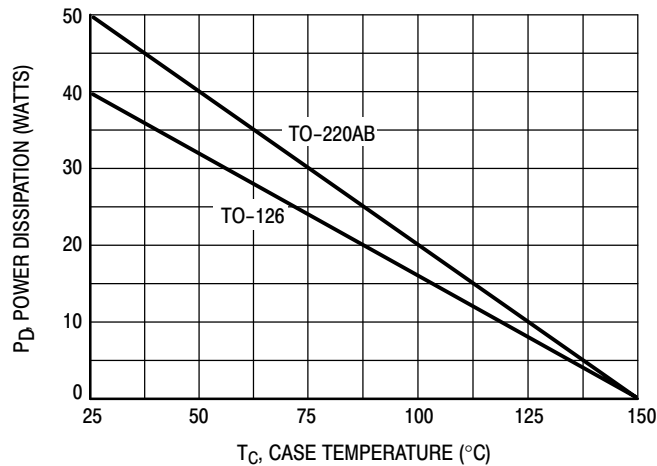

Figure 1. Power Derating

# MJE700, MJE702, MJE703 (PNP) – MJE800, MJE802, MJE803 (NPN)

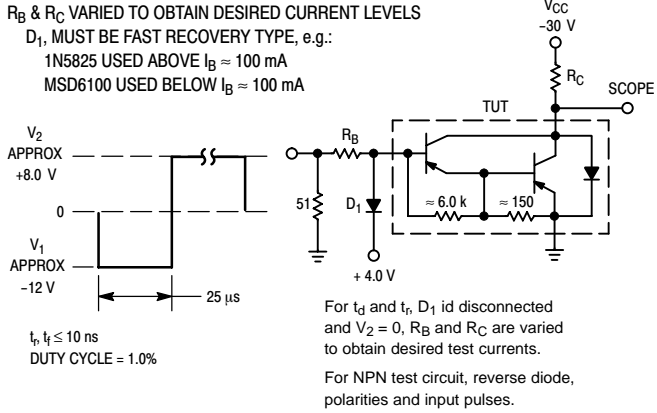

Figure 2. Switching Times Test Circuit

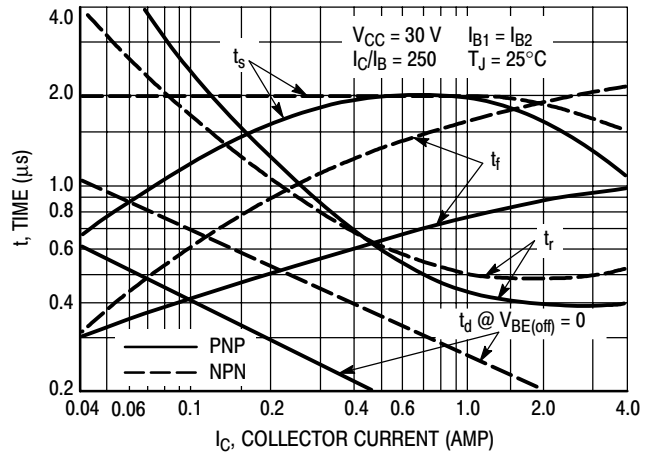

Figure 3. Switching Times

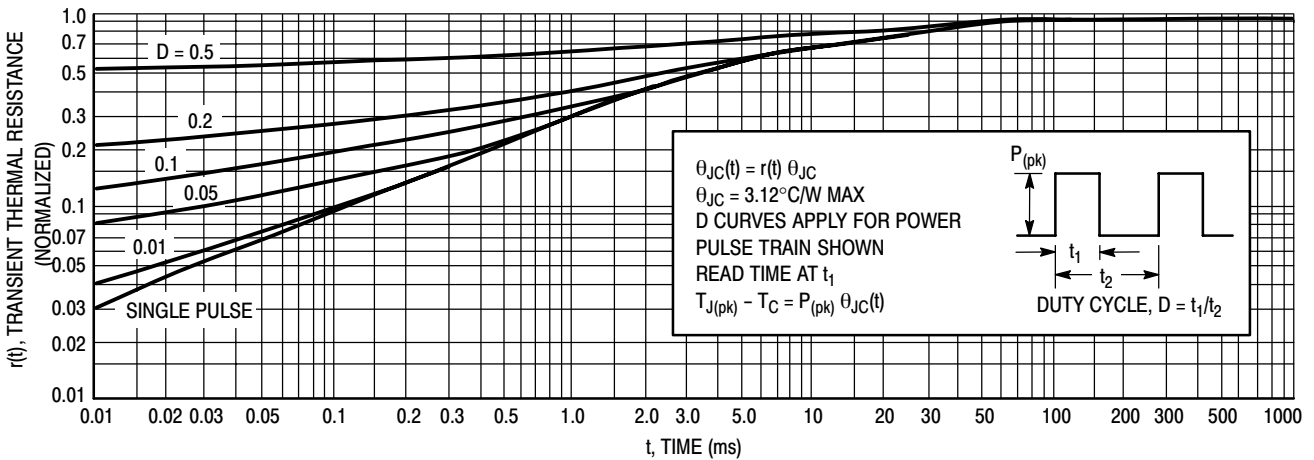

Figure 4. Thermal Response (MJE700, 800 Series)

## ACTIVE-REGION SAFE-OPERATING AREA

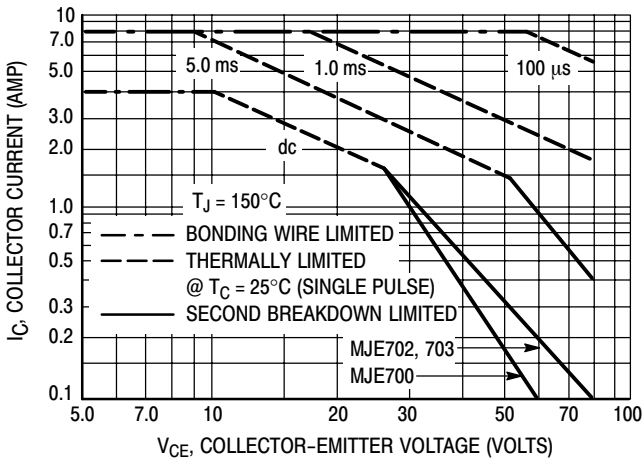

Figure 5. MJE700 Series

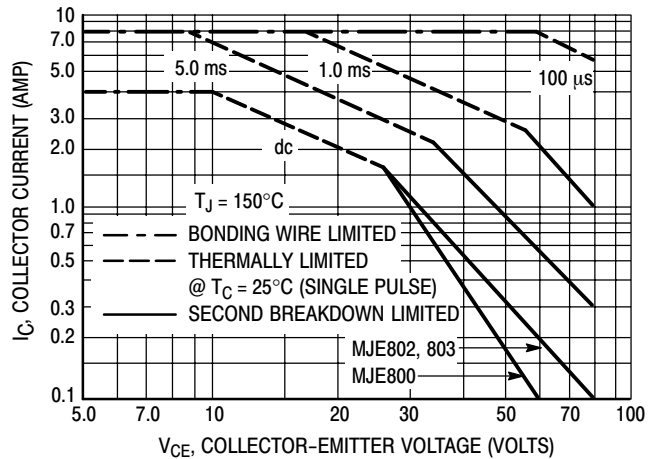

Figure 6. MJE800 Series

There are two limitations on the power handling ability of a transistor: average junction temperature and second breakdown. Safe operating area curves indicate  $I_C - V_{CE}$  limits of the transistor that must be observed for reliable operation; i.e., the transistor must not be subjected to greater dissipation than the curves indicate.

The data of Figures 5 and 6 are based on  $T_{J(pk)} = 150^\circ\text{C}$ ;  $T_C$  is variable depending on conditions. Second breakdown pulse limits are valid for duty cycles to 10% provided  $T_{J(pk)} < 150^\circ\text{C}$ .  $T_{J(pk)}$  may be calculated from the data in Figure 4. At high case temperatures, thermal limitations will reduce the power that can be handled to values less than the limitations imposed by second breakdown.

# MJE700, MJE702, MJE703 (PNP) – MJE800, MJE802, MJE803 (NPN)

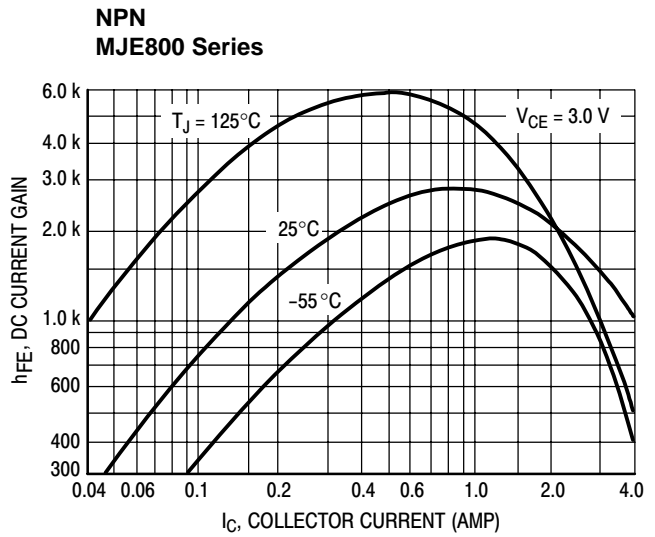
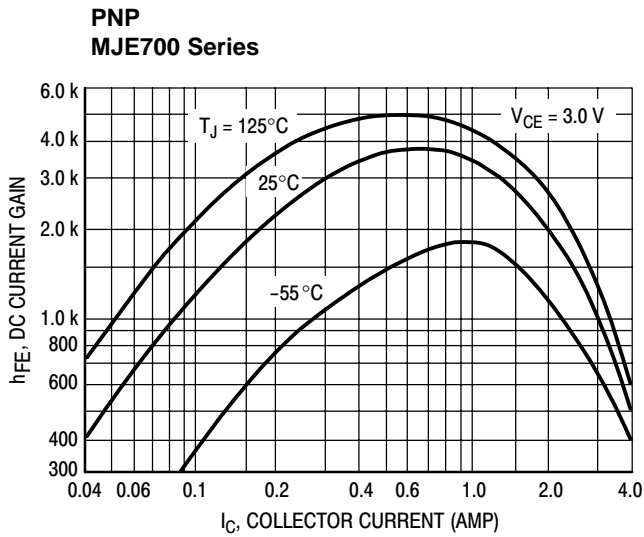

Figure 7. DC Current Gain

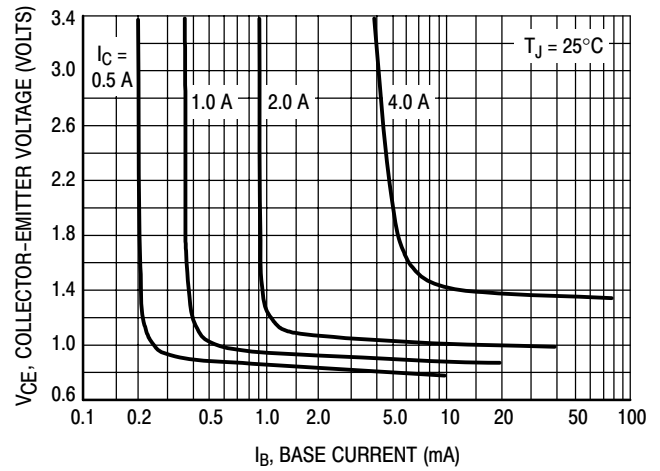
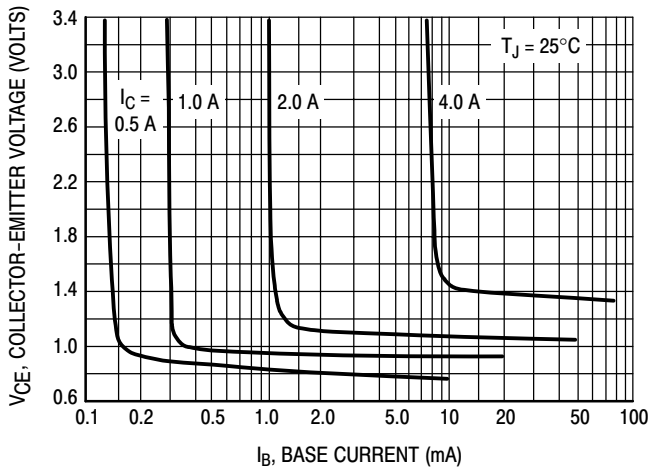

Figure 8. Collector Saturation Region

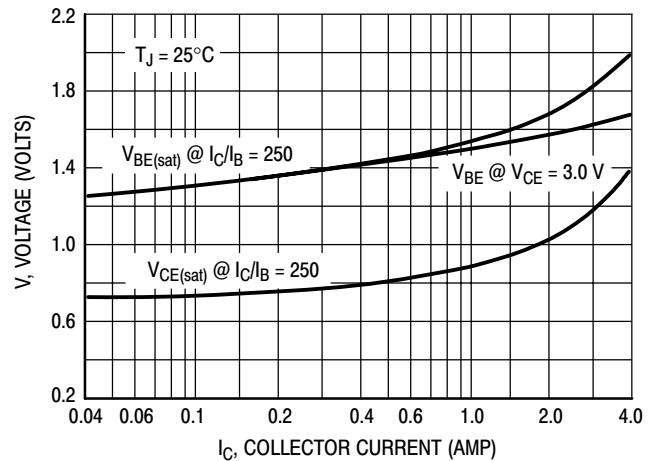
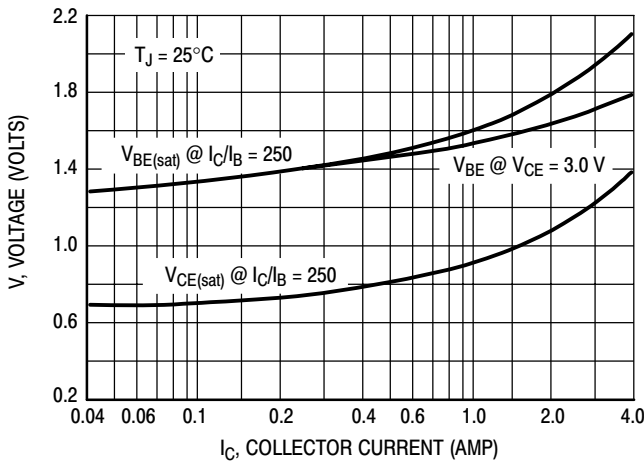

Figure 9. "On" Voltages

# MJE700, MJE702, MJE703 (PNP) – MJE800, MJE802, MJE803 (NPN)

## ORDERING INFORMATION

Device	Package	Shipping
MJE700	TO-225	50 Units / Bulk
MJE700G	TO-225 (Pb-Free)	
MJE702	TO-225	
MJE702G	TO-225 (Pb-Free)	
MJE703	TO-225	
MJE703G	TO-225 (Pb-Free)	
MJE800	TO-225	
MJE800G	TO-225 (Pb-Free)	
MJE802	TO-225	
MJE802G	TO-225 (Pb-Free)	
MJE803	TO-225	
MJE803G	TO-225 (Pb-Free)	

# MJE700, MJE702, MJE703 (PNP) – MJE800, MJE802, MJE803 (NPN)

## PACKAGE DIMENSIONS

TO-225  
CASE 77-09  
ISSUE Z

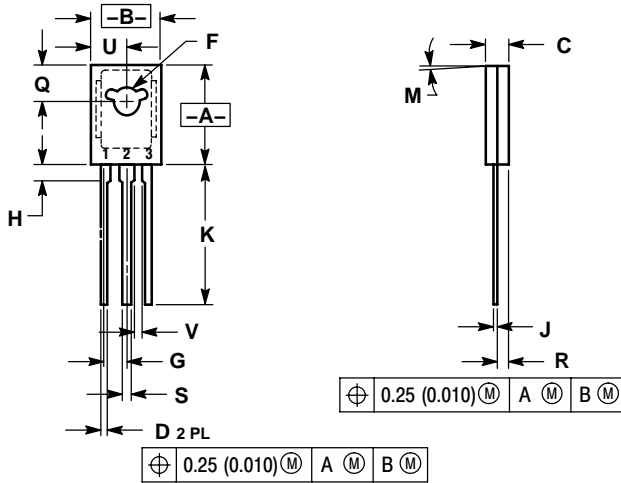

### NOTES:

1. DIMENSIONING AND TOLERANCING PER ANSI Y14.5M, 1982.
2. CONTROLLING DIMENSION: INCH.
3. 077-01 THRU -08 OBSOLETE, NEW STANDARD 077-09.

DIM	INCHES		MILLIMETERS	
	MIN	MAX	MIN	MAX
A	0.425	0.435	10.80	11.04
B	0.295	0.305	7.50	7.74
C	0.095	0.105	2.42	2.66
D	0.020	0.026	0.51	0.66
F	0.115	0.130	2.93	3.30
G	0.094 BSC		2.39 BSC	
H	0.050	0.095	1.27	2.41
J	0.015	0.025	0.39	0.63
K	0.575	0.655	14.61	16.63
M	5° TYP		5° TYP	
Q	0.148	0.158	3.76	4.01
R	0.045	0.065	1.15	1.65
S	0.025	0.035	0.64	0.88
U	0.145	0.155	3.69	3.93
V	0.040	---	1.02	---

### STYLE 1:

1. EMITTER
2. COLLECTOR
3. BASE

ON Semiconductor and are registered trademarks of Semiconductor Components Industries, LLC (SCILLC). SCILLC reserves the right to make changes without further notice to any products herein. SCILLC makes no warranty, representation or guarantee regarding the suitability of its products for any particular purpose, nor does SCILLC assume any liability arising out of the application or use of any product or circuit, and specifically disclaims any and all liability, including without limitation special, consequential or incidental damages. "Typical" parameters which may be provided in SCILLC data sheets and/or specifications can and do vary in different applications and actual performance may vary over time. All operating parameters, including "Typicals" must be validated for each customer application by customer's technical experts. SCILLC does not convey any license under its patent rights nor the rights of others. SCILLC products are not designed, intended, or authorized for use as components in systems intended for surgical implant into the body, or other applications intended to support or sustain life, or for any other application in which the failure of the SCILLC product could create a situation where personal injury or death may occur. Should Buyer purchase or use SCILLC products for any such unintended or unauthorized application, Buyer shall indemnify and hold SCILLC and its officers, employees, subsidiaries, affiliates, and distributors harmless against all claims, costs, damages, and expenses, and reasonable attorney fees arising out of, directly or indirectly, any claim of personal injury or death associated with such unintended or unauthorized use, even if such claim alleges that SCILLC was negligent regarding the design or manufacture of the part. SCILLC is an Equal Opportunity/Affirmative Action Employer. This literature is subject to all applicable copyright laws and is not for resale in any manner.

## PUBLICATION ORDERING INFORMATION

**LITERATURE FULFILLMENT:**  
Literature Distribution Center for ON Semiconductor  
P.O. Box 61312, Phoenix, Arizona 85082-1312 USA  
**Phone:** 480-829-7710 or 800-344-3860 Toll Free USA/Canada  
**Fax:** 480-829-7709 or 800-344-3867 Toll Free USA/Canada  
**Email:** orderlit@onsemi.com

**N. American Technical Support:** 800-282-9855 Toll Free  
USA/Canada

**Japan:** ON Semiconductor, Japan Customer Focus Center  
2-9-1 Kamimeguro, Meguro-ku, Tokyo, Japan 153-0051  
**Phone:** 81-3-5773-3850

**ON Semiconductor Website:** <http://onsemi.com>

**Order Literature:** <http://www.onsemi.com/litorder>

For additional information, please contact your local Sales Representative.