

MITSUBISHI LASER DIODES
ML1XX6 SERIES
 FOR OPTICAL INFORMATION SYSTEMS

**TYPE
NAME**

ML1016R, ML120G6

DESCRIPTION

ML1XX6 is a high power AlGaInP semiconductor laser which provides a stable, single transverse mode oscillation with emission wavelength of 658-nm and standard CW light output of 30mW.

ML1XX6 has a window-mirror-facet which improves the maximum output power. That leads to highly reliable and high-power operation.

FEATURES

- High Power: 30mW (CW), 50mW (pulse)
- Visible Light: 658nm (typ)

APPLICATION

DVD(Digital Versatile Disc)-RAM/RW Drive

ABSOLUTE MAXIMUM RATINGS Note 1)

Symbol	Parameter	Conditions	Ratings	Unit
Po	Light output power	CW	35	mW
		Pulse(Note 2)	50	
VRL	Reverse voltage (laser diode)	-	2	V
VRD	Reverse voltage (Photodiode)	-	30	V
IFD	Forward current (Photodiode)	-	10	mA
Tc	Case temperature	-	-10 ~ +60	°C
Tstg	Storage temperature	-	-40 ~ +100	°C

Note1: The maximum rating means the limitation over which the laser should not be operated even instant time, and this does not mean the guarantee of its lifetime. As for the reliability, please refer to the reliability report from Mitsubishi Semiconductor Quality Assurance Department.

Note2: TARGET SPEC /Condition Duty less than 50%, pulse width less than 1μs

ELECTRICAL/OPTICAL CHARACTERISTICS (Tc=25°C)

Symbol	Parameter	Test conditions	Min.	Typ.	Max	Unit
I _{th}	Threshold current	CW	-	40	70	mA
I _{op}	Operating current	CW, Po=30mW	-	80	120	mA
V _{op}	Operating voltage	CW, Po=30mW	-	2.7	3.0	V
η	Slope efficiency	CW, Po=30mW	-	0.7	-	mW/mA
λ _p	Peak wavelength	CW, Po=30mW	655	658	666	nm
θ _{//}	Beam divergence angle (parallel)	CW, Po=30mW	7	8.5	11	°
θ _⊥	Beam divergence angle (perpendicular)	CW, Po=30mW	17	22	26	°
I _m	Monitoring output current (Photodiode) (only for ML1016R)	CW, Po=30mW, VRD=1V RL=10Ω(Note 3)	0.05	0.35	2.5	mA
I _D	Dark current (Photodiode)	VRD=10V	-	-	0.5	mA
C _t	Capacitance (Photodiode)	f=1MHz, VRD=5V	-	7	-	pF

Note 3: RL=the load resistance of photodiode for ML1016R

MITSUBISHI LASER DIODES
ML1XX6 SERIES
 FOR OPTICAL INFORMATION SYSTEMS

OUTLINE DRAWINGS

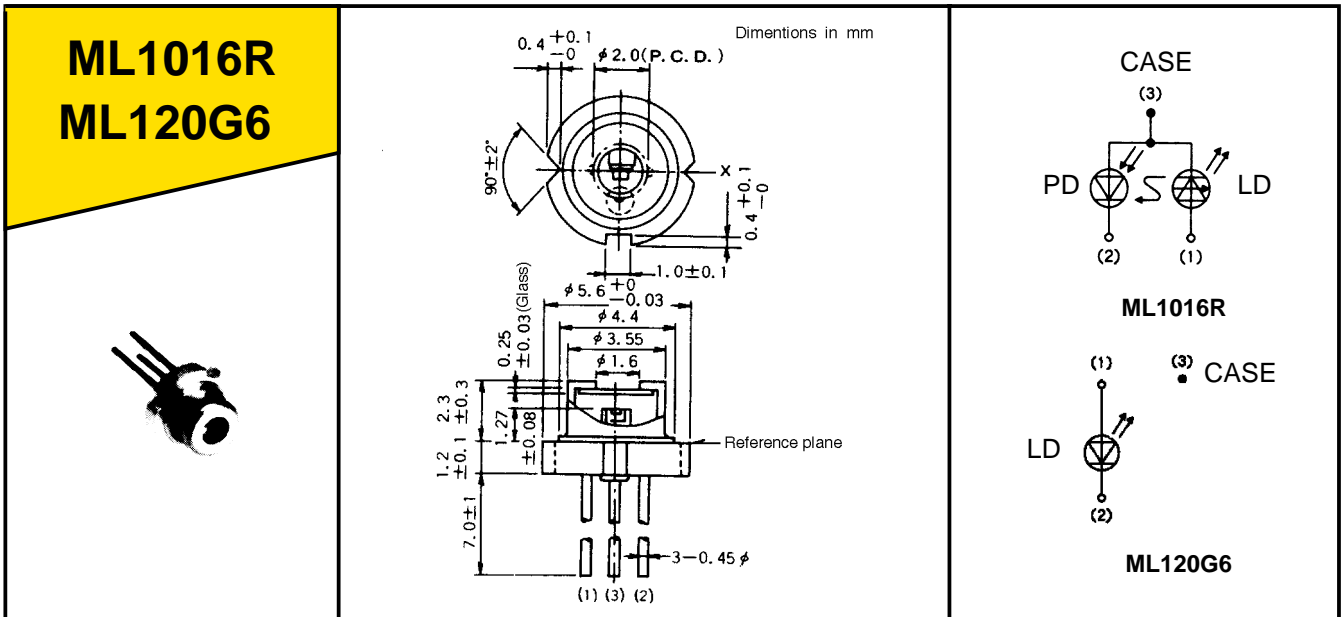

Typical Characteristics

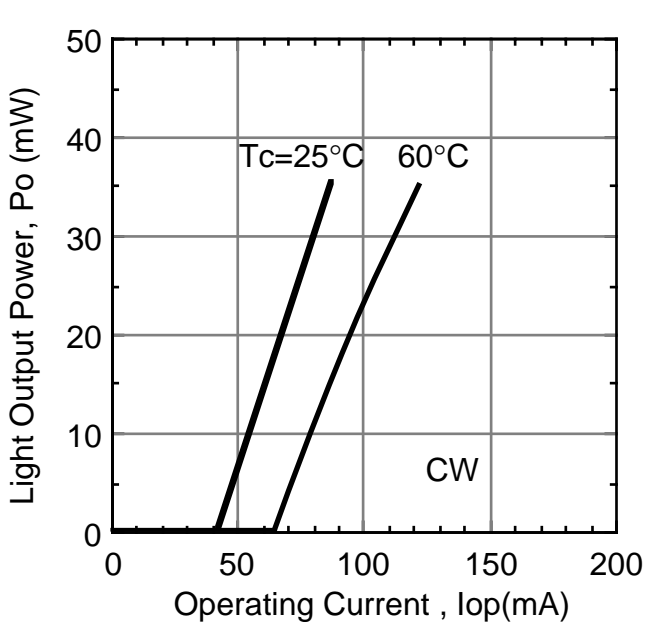

Light Output Power vs. Current (CW)

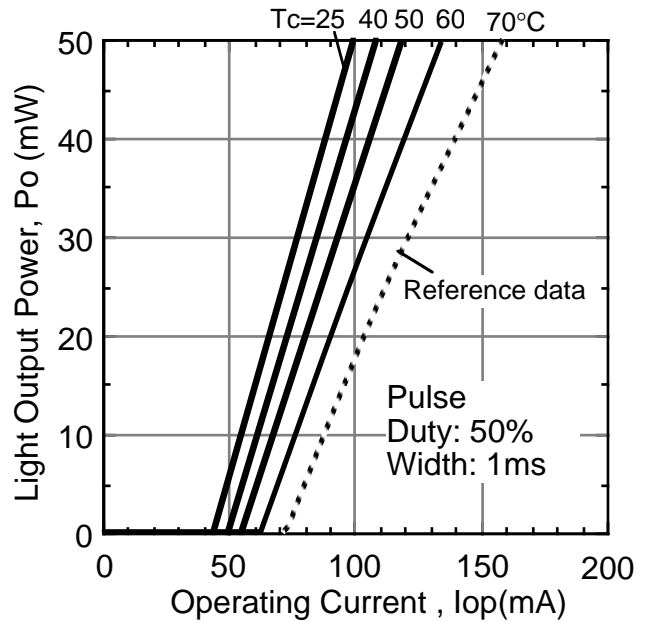

Light Output Power vs. Current (Pulse)

Typical Characteristics

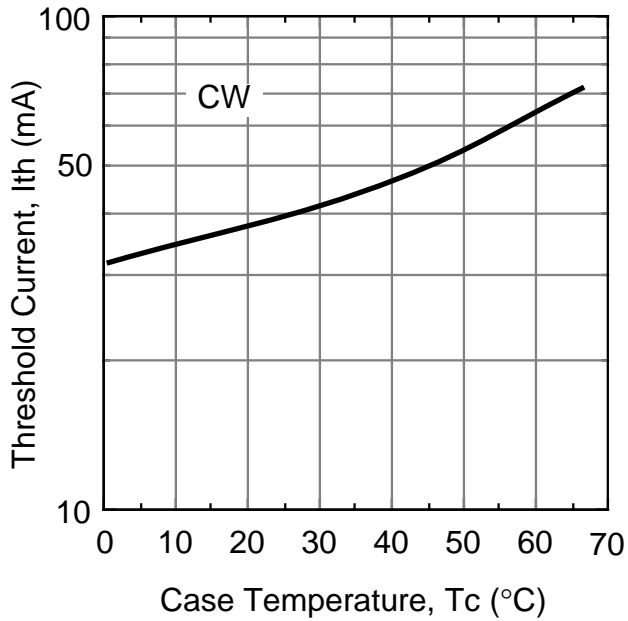

Threshold Current vs. Temperature

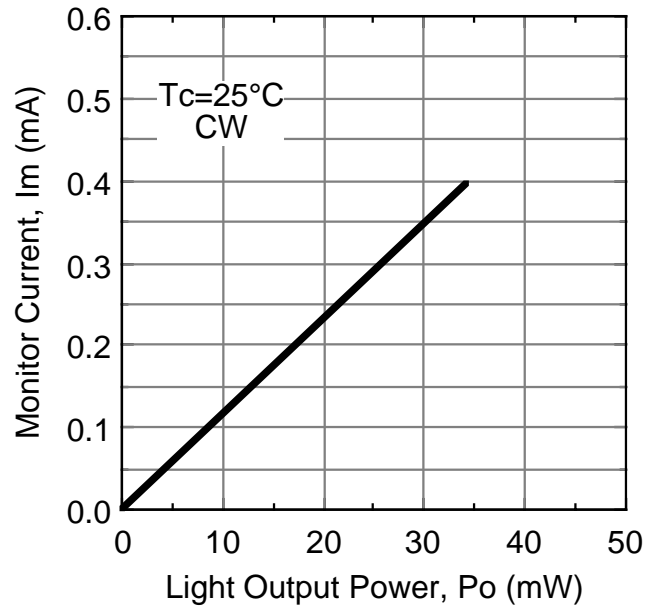

Monitor Photodiode Current

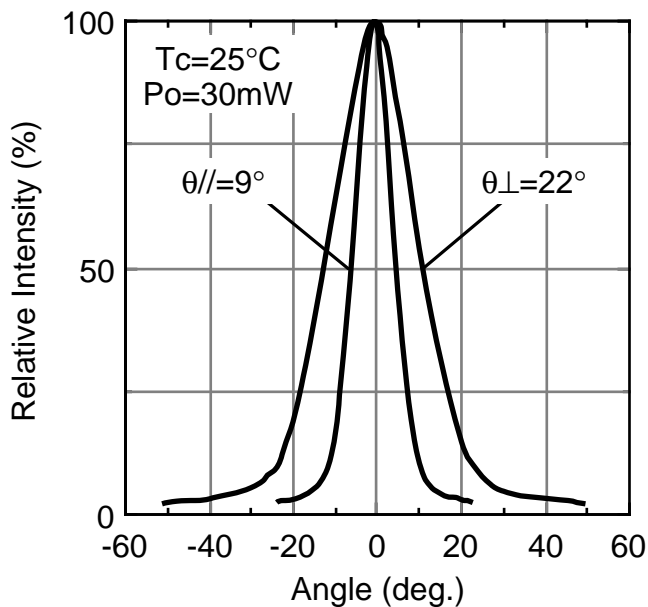

Far-Field-Patterns

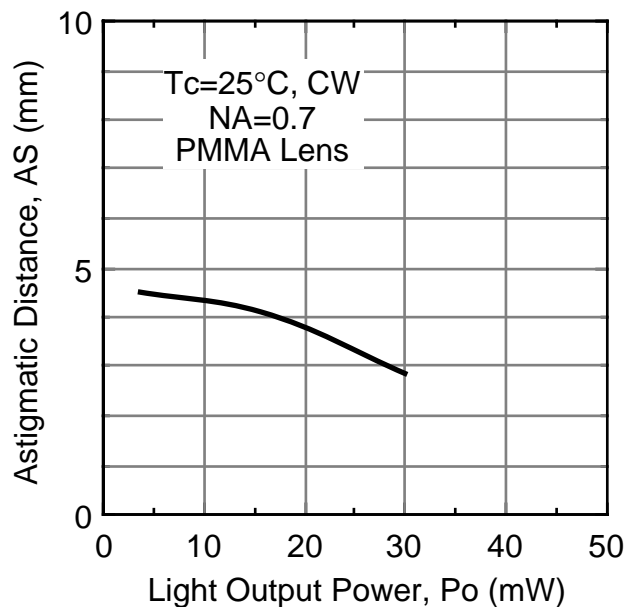

Astigmatic Distance

Typical Characteristics

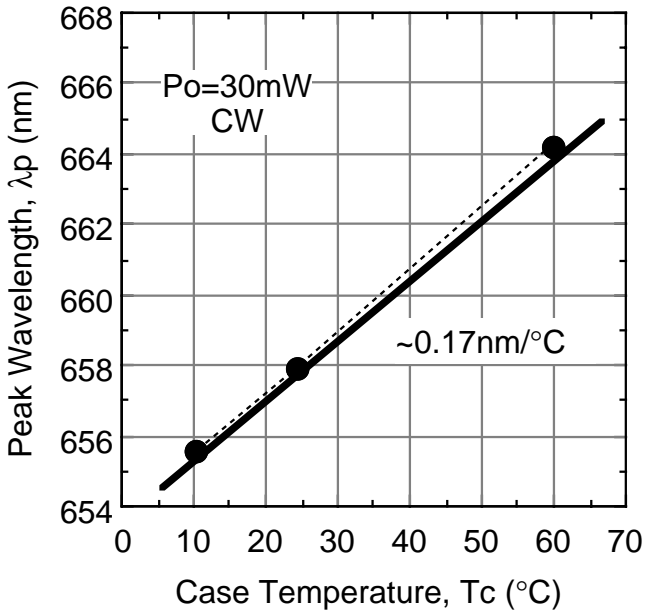

Peak Wavelength vs. Temperature

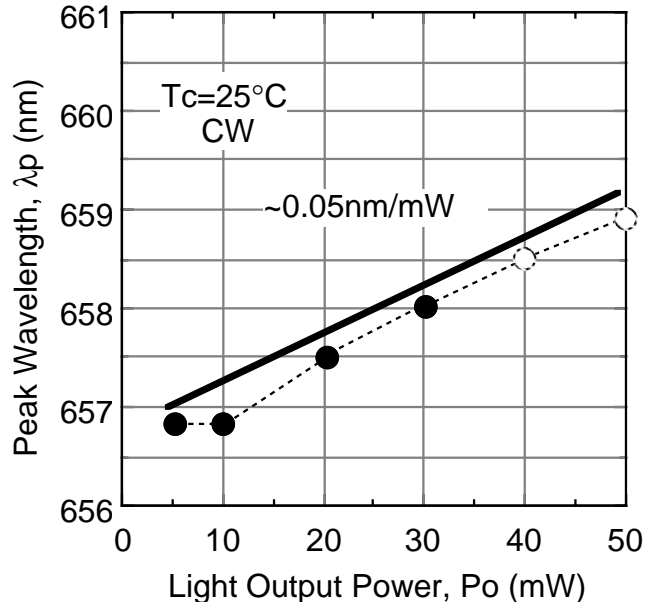

Peak Wavelength vs. Light Output Power

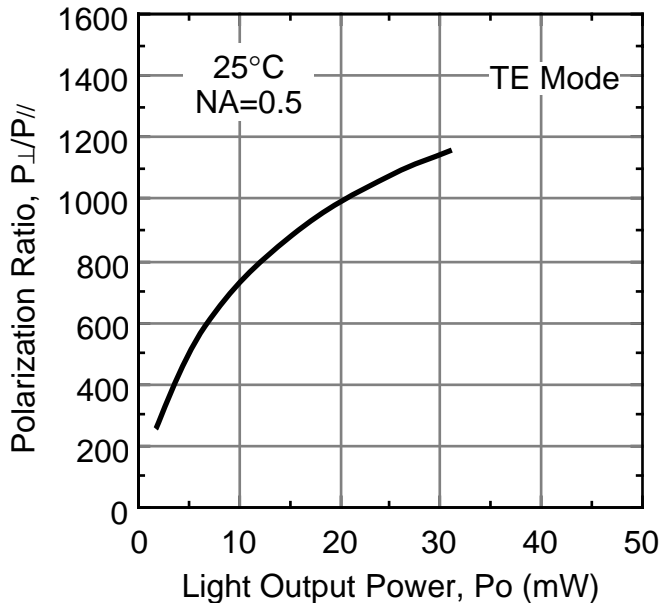

Polarization Ratio