

ML6201 Series Positive Voltage Regulator

❖ Application

- ◆ Battery Powered Equipment
- ◆ Palmtops
- ◆ Portable Cameras and Video Recorders
- ◆ Reference Voltage Sources

❖ Features

- CMOS Low Power Consumption :
Typical 3.3uA at $V_{out}=5.0V$
- Output Voltage Range : 1.1V to 6.0V in 0.1V increments
- Highly Accurate:
Output Voltage $\pm 3\%$ for 1.1V to 1.9V
Output Voltage $\pm 2\%$ for 2.0V to 6.0V
- Maximum Output Current: 250mA
(within the maximum power dissipation, $V_{out}=5.0V$)
- Small Input-Output Voltage Differential:
0.16V at 100mA and 0.4V at 200mA
- Input stability: Typ. 0.2%/V
- Package Available:
SOT-23-5 (250mW), SOT-89 (500mW) &
TO-92 (300mW)

❖ General Description

The ML6201 is a group of positive voltage output, three-pin regulator which provides high output current even when the input/output voltage differential is small.

The ML6201 consists of a high-precision voltage reference, an error correction circuit, and a current limited output driver.

❖ Block Diagram

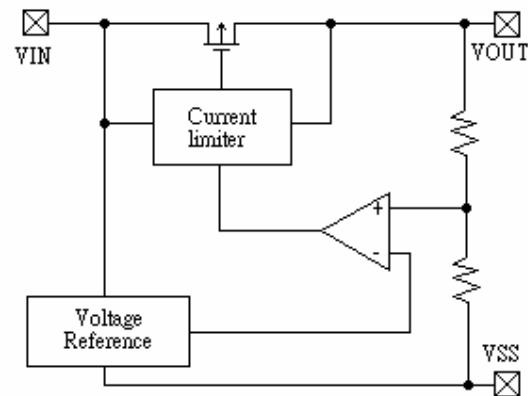

❖ Absolute Maximum Ratings

Parameter		Symbol	Ratings	Units
Input Voltage		V_{IN}	10	V
Output Current		I_{OUT}	500	mA
Output Voltage		V_{OUT}	$V_{SS}-0.3 \sim V_{IN}+0.3$	V
Continuous Total Power Dissipation	SOT-23-5	P_d	250	mW
	SOT-89		500	
	TO-92		300	
Operating Ambient Temperature		T_{opr}	-40 ~ +70	°C
Storage Temperature		T_{stg}	-40 ~ +70	°C

❖ *Pin Configuration*

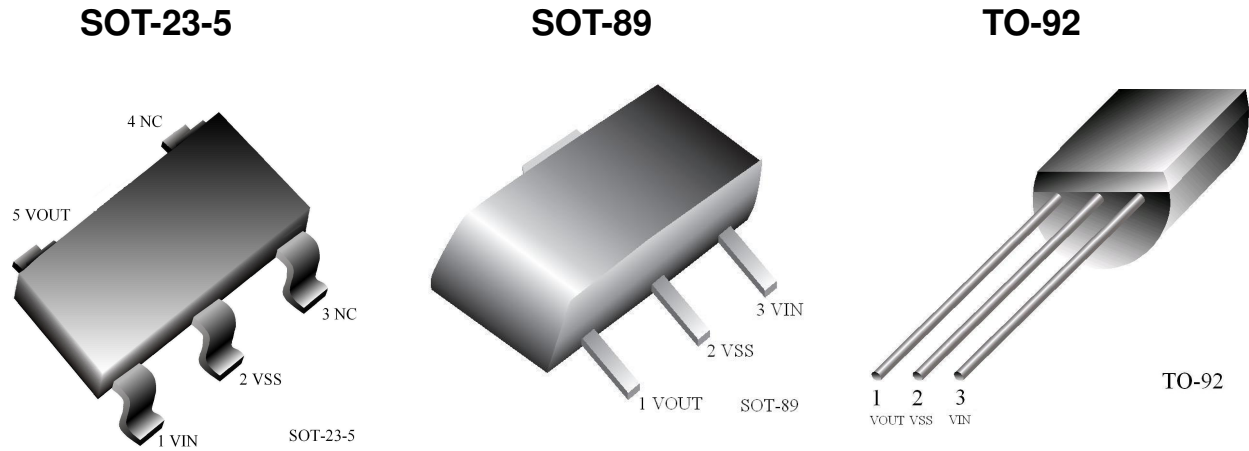

Package Pin Number			Pin Name	Function
SOT-23-5	SOT-89	TO-92		
5	1	1	VOUT	Output
2	2	2	VSS	Ground
1	3	3	VIN	Power Input
3			(NC)	No Connection
4			(NC)	No Connection

❖ *Standard Circuit*

Note on Use

- Oscillation may occur as a result of the impedance present between the power supply and the IC's input. Please use a capacitor (CIN) of at least 1uF, when the impedance is 10 ohm or more. With a large output current, Voltage output can be stabilised by increasing capacitor (CIN) size. If CIN is small and capacitor (CL) size is increased, oscillation may occur. In such cases, Voltage output can be stabilised by either increasing the size of CIN or decreasing the size of CL.
- Please ensure that output current (IOUT) is less than $Pd / (VIN - VOUT)$ and does not exceed the stipulated Continuous Total Power Dissipation value (Pd).

❖ *Test Circuit*

Test Circuit 1

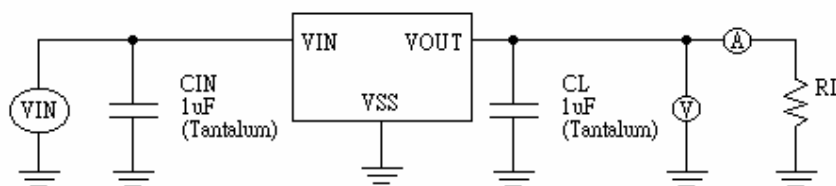

Test Circuit 2

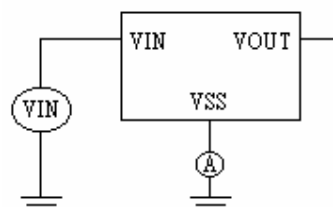

❖ **Electrical Characteristic****ML6201P502 $V_{OUT}(T)=5.0V$ (Note 1)**

Parameter	Symbol	Conditions	Min	Typ	Max	Units	Circuit
Output Voltage	$V_{OUT}(E)$ (Note 2)	$I_{OUT}=40mA$ $V_{IN}=6.0V$	4.900	5.000	5.100	V	1
Maximum Output Current	$I_{OUT\ max}$	$V_{IN}=6.0V, V_{OUT}(E) \geq 4.5V$	250			mA	1
Load Stability	ΔV_{OUT}	$V_{IN}=6.0V, 1mA \leq I_{OUT} \leq 100mA$		40	80	mV	1
Input –Output Voltage Differential (Note 3)	V_{dif1}	$I_{OUT}=100mA$		120	400	mV	1
	V_{dif2}	$I_{OUT}=200mA$		380	750	mV	1
Supply Current	ISS	$V_{IN}=6.0V$		3.3	4.5	μA	2
Input Stability	$\frac{\Delta V_{OUT}}{\Delta V_{IN} * V_{OUT}}$	$I_{OUT}=40mA$ $6.0V \leq V_{IN} \leq 10.0V$		0.2	0.3	%V	1
Input Voltage	V_{IN}				10	V	-

ML6201P402 $V_{OUT}(T)=4.0V$ (Note 1)

Parameter	Symbol	Conditions	Min	Typ	Max	Units	Circuit
Output Voltage	$V_{OUT}(E)$ (Note 2)	$I_{OUT}=40mA$ $V_{IN}=5.0V$	3.920	4.000	4.080	V	1
Maximum Output Current	$I_{OUT\ max}$	$V_{IN}=5.0V, V_{OUT}(E) \geq 3.6V$	200			mA	1
Load Stability	ΔV_{OUT}	$V_{IN}=5.0V, 1mA \leq I_{OUT} \leq 100mA$		45	90	mV	1
Input –Output Voltage Differential (Note 3)	V_{dif1}	$I_{OUT}=90mA$		170	400	mV	1
	V_{dif2}	$I_{OUT}=180mA$		400	750	mV	1
Supply Current	ISS	$V_{IN}=5.0V$		3.0	4.5	μA	2
Input Stability	$\frac{\Delta V_{OUT}}{\Delta V_{IN} * V_{OUT}}$	$I_{OUT}=40mA$ $5.0V \leq V_{IN} \leq 10.0V$		0.2	0.3	%V	1
Input Voltage	V_{IN}				10	V	-

ML6201P302 $V_{OUT}(T)=3.0V$ (Note 1)

Parameter	Symbol	Conditions	Min	Typ	Max	Units	Circuit
Output Voltage	$V_{OUT}(E)$ (Note 2)	$I_{OUT}=40mA$ $V_{IN}=4.0V$	2.940	3.000	3.060	V	1
Maximum Output Current	$I_{OUT\ max}$	$V_{IN}=4.0V, V_{OUT}(E) \geq 2.7V$	150			mA	1
Load Stability	ΔV_{OUT}	$V_{IN}=4.0V, 1mA \leq I_{OUT} \leq 80mA$		45	90	mV	1
Input –Output Voltage Differential (Note 3)	V_{dif1}	$I_{OUT}=80mA$		180	450	mV	1
	V_{dif2}	$I_{OUT}=150mA$		400	850	mV	1
Supply Current	ISS	$V_{IN}=4.0V$		2.8	4.5	μA	2
Input Stability	$\frac{\Delta V_{OUT}}{\Delta V_{IN} * V_{OUT}}$	$I_{OUT}=40mA$ $4.0V \leq V_{IN} \leq 10.0V$		0.2	0.3	%V	1
Input Voltage	V_{IN}				10	V	-

ML6201P202 $V_{OUT}(T)=2.0V$ (Note 1)

Parameter	Symbol	Conditions	Min	Typ	Max	Units	Circuit
Output Voltage	$V_{OUT}(E)$ (Note 2)	$I_{OUT}=40mA$ $V_{IN}=3.0V$	1.960	2.000	2.040	V	1
Maximum Output Current	$I_{OUT\ max}$	$V_{IN}=3.0V, V_{OUT}(E) \geq 1.8V$	100			mA	1
Load Stability	ΔV_{OUT}	$V_{IN}=3.0V, 1mA \leq I_{OUT} \leq 60mA$		45	90	mV	1
Input –Output Voltage Differential (Note 3)	V_{dif1}	$I_{OUT}=60mA$		180	450	mV	1
	V_{dif2}	$I_{OUT}=100mA$		400	850	mV	1
Supply Current	ISS	$V_{IN}=3.0V$		2.5	4.5	μA	2
Input Stability	$\frac{\Delta V_{OUT}}{\Delta V_{IN} * V_{OUT}}$	$I_{OUT}=40mA$ $3.0V \leq V_{IN} \leq 10.0V$		0.2	0.3	%V	1
Input Voltage	V_{IN}				10	V	-

Note : 1. $V_{OUT}(T)$ = Specified Output Voltage.

2. $V_{OUT}(E)$ = Effective Output Voltage (i.e. the output voltage when ($V_{OUT}(T)+1.0V$) is provided at the V_{IN} pin while maintaining a certain I_{OUT} value).

3. V_{dif} = $V_{IN1}(\text{Note 4}) - V_{OUT}(E)$

4. V_{IN1} = The input voltage at the time 98% of $V_{OUT}(E)$ is output (input voltage has been gradually reduced).



❖ *Electrical Characteristics by Output Voltage*

Part Number	Output voltage				Max Output Current		Load Stability			I-O Voltage Differential									
	V _{OUT} (V)				I _{OUT max} (mA)		Δ V _{OUT} (mV)			V _{diff} (mV)									
	Conditions	MIN.	TYP.	MAX.	Conditions	MIN.	Conditions	TYP.	MAX.	Conditions	TYP.	MAX.							
ML6201P113	I _{OUT} =40mA V _{IN} =V _{OUT} (T)+1V	1.067	1.100	1.133	V _{IN} =V _{OUT} (T)+1V V _{OUT} (E)≥ V _{OUT} (T)*0.9	80	V _{IN} =V _{OUT} (T)+1V 1mA<I _{OUT} <40mA	45	90	I _{OUT} =20mA	250	450							
ML6201P123		1.164	1.200	1.236						I _{OUT} =30mA	250	450							
ML6201P133		1.261	1.300	1.339						I _{OUT} =40mA	250	450							
ML6201P143		1.358	1.400	1.442															
ML6201P153		1.455	1.500	1.545															
ML6201P163		1.552	1.600	1.648						100	V _{IN} =V _{OUT} (T)+1V 1mA≤I _{OUT} ≤60mA	45	90	I _{OUT} =60mA	180	450			
ML6201P173		1.649	1.700	1.751															
ML6201P183		1.746	1.800	1.854															
ML6201P193		1.843	1.900	1.957															
ML6201P202		1.960	2.000	2.040															
ML6201P212		2.058	2.100	2.142															
ML6201P222		2.156	2.200	2.244															
ML6201P232		2.254	2.300	2.346															
ML6201P242		2.352	2.400	2.448															
ML6201P252		2.450	2.500	2.550															
ML6201P262		2.548	2.600	2.652															
ML6201P272		2.646	2.700	2.754															
ML6201P282		2.744	2.800	2.856															
ML6201P292		2.842	2.900	2.958															
ML6201P302		2.940	3.000	3.060															
ML6201P312		3.038	3.100	3.162		150	V _{IN} =V _{OUT} (T)+1V 1mA≤I _{OUT} ≤80mA	45	90	I _{OUT} =80mA	180	450							
ML6201P322		3.136	3.200	3.264															
ML6201P332		3.234	3.300	3.366															
ML6201P342		3.332	3.400	3.468															
ML6201P352		3.430	3.500	3.570															
ML6201P362		3.528	3.600	3.672															
ML6201P372		3.626	3.700	3.774		200	V _{IN} =V _{OUT} (T)+1V 1mA≤I _{OUT} ≤100mA	45	90	I _{OUT} =90mA	170	400							
ML6201P382		3.724	3.800	3.876															
ML6201P392		3.822	3.900	3.978															
ML6201P402		3.920	4.000	4.080															
ML6201P412		4.018	4.100	4.182															
ML6201P422		4.116	4.200	4.284															
ML6201P432		4.214	4.300	4.386															
ML6201P442		4.312	4.400	4.488															
ML6201P452		4.410	4.500	4.590															
ML6201P462		4.508	4.600	4.692															
ML6201P472		4.606	4.700	4.794															
ML6201P482		4.704	4.800	4.896															
ML6201P492		4.802	4.900	4.998															
ML6201P502		4.900	5.000	5.100									250	V _{IN} =V _{OUT} +1V 1mA≤I _{OUT} ≤100mA	40	80	I _{OUT} =100mA	120	400
ML6201P512		4.998	5.100	5.202															
ML6201P522		5.096	5.200	5.304															
ML6201P532		5.194	5.300	5.406															
ML6201P542		5.292	5.400	5.508															
ML6201P552		5.390	5.500	5.610															
ML6201P562		5.488	5.600	5.712															
ML6201P572		5.586	5.700	5.814															
ML6201P582		5.684	5.800	5.916															
ML6201P592		5.782	5.900	6.018															
ML6201P602		5.880	6.000	6.120															



Part Number	I-O Voltage Differential			Supply Current			Input Stability			Input Voltage
	V _{diff2} (mV)			I _{SS} (uA)			Δ V _{OUT} /(Δ V _{IN} *V _{OUT}) (%V)			V _{IN} (V)
	Conditions	TYP.	MAX.	Conditions	TYP.	MAX.	Conditions	TYP.	MAX.	MAX.
ML6201P113	I _{OUT} =40mA	450	850	V _{IN} =V _{OUT} (T)+1V	2.0	4.5	I _{OUT} =40mA V _{OUT} (T)+1V ≤ V _{IN} ≤ 10V	0.2	0.4	10
ML6201P123										
ML6201P133										
ML6201P143	I _{OUT} =60mA	450	850							
ML6201P153										
ML6201P163										
ML6201P173	I _{OUT} =80mA	450	850							
ML6201P183										
ML6201P193										
ML6201P202	I _{OUT} =100mA	400	850							
ML6201P212										
ML6201P222										
ML6201P232										
ML6201P242										
ML6201P252										
ML6201P262										
ML6201P272										
ML6201P282										
ML6201P292										
ML6201P302	I _{OUT} =150mA	400	850							
ML6201P312										
ML6201P322										
ML6201P332										
ML6201P342										
ML6201P352										
ML6201P362										
ML6201P372										
ML6201P382										
ML6201P392										
ML6201P402	I _{OUT} =180mA	400	750							
ML6201P412										
ML6201P422										
ML6201P432										
ML6201P442										
ML6201P452										
ML6201P462										
ML6201P472										
ML6201P482										
ML6201P492										
ML6201P502	I _{OUT} =200mA	380	750							
ML6201P512										
ML6201P522										
ML6201P532										
ML6201P542										
ML6201P552										
ML6201P562										
ML6201P572										
ML6201P582										
ML6201P592										
ML6201P602										

❖ **Ordering Information**

Designator	Description
a	Output Voltage eg. 30=3.0V 50=5.0V
b	Output Voltage Accuracy 2 = ± 2.0% 3 = ± 3.0%
c	Package Type M = SOT-23-5 P = SOT-89 T = TO-92
d	Device Orientation R = Embossed Tape (Orientation of Device : Right) L = Embossed Tape (Orientation of Device : Left) B = Bag (TO-92) H = Paper Tape (TO-92)
G	G = Lead Free Part

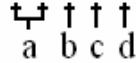
ML6201P x x x x x G

❖ **Marking**

SOT-23-5 :

Designator	Description
1	Type V = Positive Voltage Regulator
2,3	Output Voltage eg. 30 = 3.0V
4	Internal Code

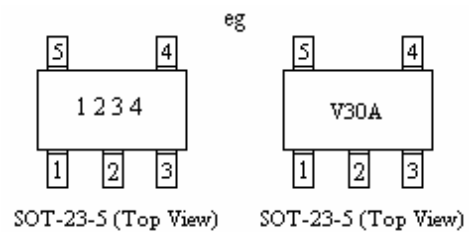

SOT-89 :

Designator	Description
1	Type V = Positive Voltage Regulator
2,3	Output Voltage eg. 30 = 3.0V
4	Output Voltage Accuracy 2 = ± 2.0% 3 = ± 3.0%
5	Internal Code

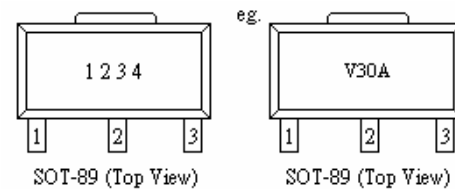

TO-92 :

Designator	Description
1	Type V = Positive Voltage Regulator
2,3	Output Voltage eg. 30 = 3.0V
4	Output Voltage Accuracy 2 = ± 2.0% 3 = ± 3.0%
5	Internal code
6, 7	Year Code eg. 05 = Year 2005
8, 9	Week Code eg. 30 = Week 30

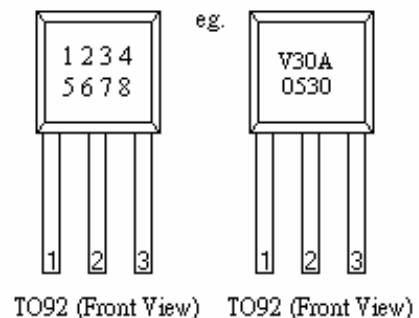

The information presented in this document does not form part of any quotation or contract, is believed to be accurate and reliable and may be changed without notice. No liability will be accepted by the publisher for any consequence of its use.