ML63187/63189B

**4-Bit Microcontroller with Built-in 1024-Dot Matrix LCD Drivers and Melody Circuit,
Operating at 0.9 V (Min.)**

GENERAL DESCRIPTION

The ML63187/63189B is a CMOS 4-bit microcontroller with built-in 1024-dot matrix LCD drivers and operates at 0.9 V (min.). The ML63187/63189B is suitable for applications such as games, toys, watches, etc. which are provided with an LCD display.

The ML63187/63189B is an M6318x series mask ROM-version product of OLMS-63K family, which employs Oki's original CPU core nX-4/250.

FEATURES

- Rich instruction set
 - 408 instructions
 - Transfer, rotate, increment/decrement, arithmetic operations, comparison, logic operations, mask operations, bit operations, ROM table reference, stack operations, flag operations, branch, conditional branch, call/return, control.
- Rich selection of addressing modes
 - Indirect addressing of four data memory types, with current bank register, extra bank register, HL register and XY register.
 - Data memory bank internal direct addressing mode.
- Processing speed
 - Two clocks per machine cycle, with most instructions executed in one machine cycle.
 - Minimum instruction execution time : 61 μ s (@ 32.768 kHz system clock)
1 μ s (@ 2 MHz system clock)
- Clock generation circuit
 - Low-speed clock : Crystal oscillation or RC oscillation selected with mask option (30 to 80 kHz)
 - High-speed clock : Ceramic oscillation or RC oscillation selected with software (2 MHz max.)
- Program memory space
 - ML63187 : 16K words
 - ML63189B : 32K words
 - Basic instruction length is 16 bits/1 word
- Data memory space
 - ML63187 : 1024 nibbles
 - ML63189B : 1536 nibbles

- Stack level
 - Call stack level : 16 levels
 - Register stack level : 16 levels

- I/O ports
 - Input ports: Selectable as input with pull-up resistor/input with pull-down resistor/high-impedance input
 - Input-output ports: Selectable as input with pull-up resistor/input with pull-down resistor/high-impedance input
Selectable as P-channel open drain output/N-channel open drain output/CMOS output/high-impedance output
 - Can be interfaced with external peripherals that use a different power supply than this device uses.
 - Number of ports:
 - ML63187
 - Input-output port : 2 ports × 4 bits
 - ML63189B
 - Input port : 1 port × 4 bits
 - Input-output port : 4 ports × 4 bits

- Melody output
 - Melody frequency : 529 to 2979 Hz
 - Tone length : 63 types
 - Tempo : 15 types
 - Melody data : Resides in the program memory
 - Buzzer driver signal output : 4 kHz

- LCD driver
 - Number of segments : 1024 Max. (64 SEG × 16 COM)
 - 1/1 to 1/16 duty
 - 1/4 or 1/5 bias (regulator built-in)
 - Selectable as all-ON mode/all-OFF mode/power down mode/normal display mode
 - Adjustable contrast



- Reset function
 - Reset through RESET pin
 - Power-on reset
 - Reset by low-speed oscillation halt

- Battery check
 - Low-voltage supply check
 - The value of the judgment voltage is selected by the software by setting the LD1 and LD0 bits of BLDCON.

LD1	LD0	Judgment Voltage (V)	Remarks
0	0	1.05 ±0.10	Ta = 25°C
0	1	1.20 ±0.10	Ta = 25°C
1	0	1.80 ±0.10	Ta = 25°C
1	1	2.40 ±0.10	Ta = 25°C



- Power supply backup
Backup circuit (voltage multiplier) enables operation at 0.9 V minimum
- Timers and counter
8-bit timer × 4
 Selectable as auto-reload mode/capture mode/clock frequency measurement mode
Watchdog timer × 1
100 Hz timer × 1
 Measurable in steps of 1/100 sec.
15-bit time base counter × 1
 1, 2, 4, 8, 16, 32, 64, and 128 Hz signals can be read
- Shift register
Shift clock : 1 × or 1/2 × system clock, timer 1 overflow, external clock
Data length : 8 bits
- Interrupt sources
ML63187
External interrupt : 2
Internal interrupt : 12 (watchdog timer interrupt is a nonmaskable interrupt)
ML63189B
External interrupt : 3
Internal interrupt : 12 (watchdog timer interrupt is a nonmaskable interrupt)
- Operating temperature
-20 to +70°C
- Operating voltage
When backup used : 0.9 to 2.7 V
 (Operating frequency: 30 to 80 kHz)
 1.2 to 2.7 V
 (Operating frequency: 300 to 500 kHz)
 1.5 to 2.7 V
 (Operating frequency: 200 kHz to 1 MHz)
When backup not used : 1.8 to 5.5 V
 (Operating frequency: 200 kHz to 2 MHz)
- Package:
128-pin plastic QFP (QFP128-P-1420-0.50-K) : (Product name: ML63187-xxxGA, ML63189B-xxxGA)
Chip : ML63187-xxx, ML63189B-xxx
 xxx indicates a code number.

BLOCK DIAGRAM (ML63187)

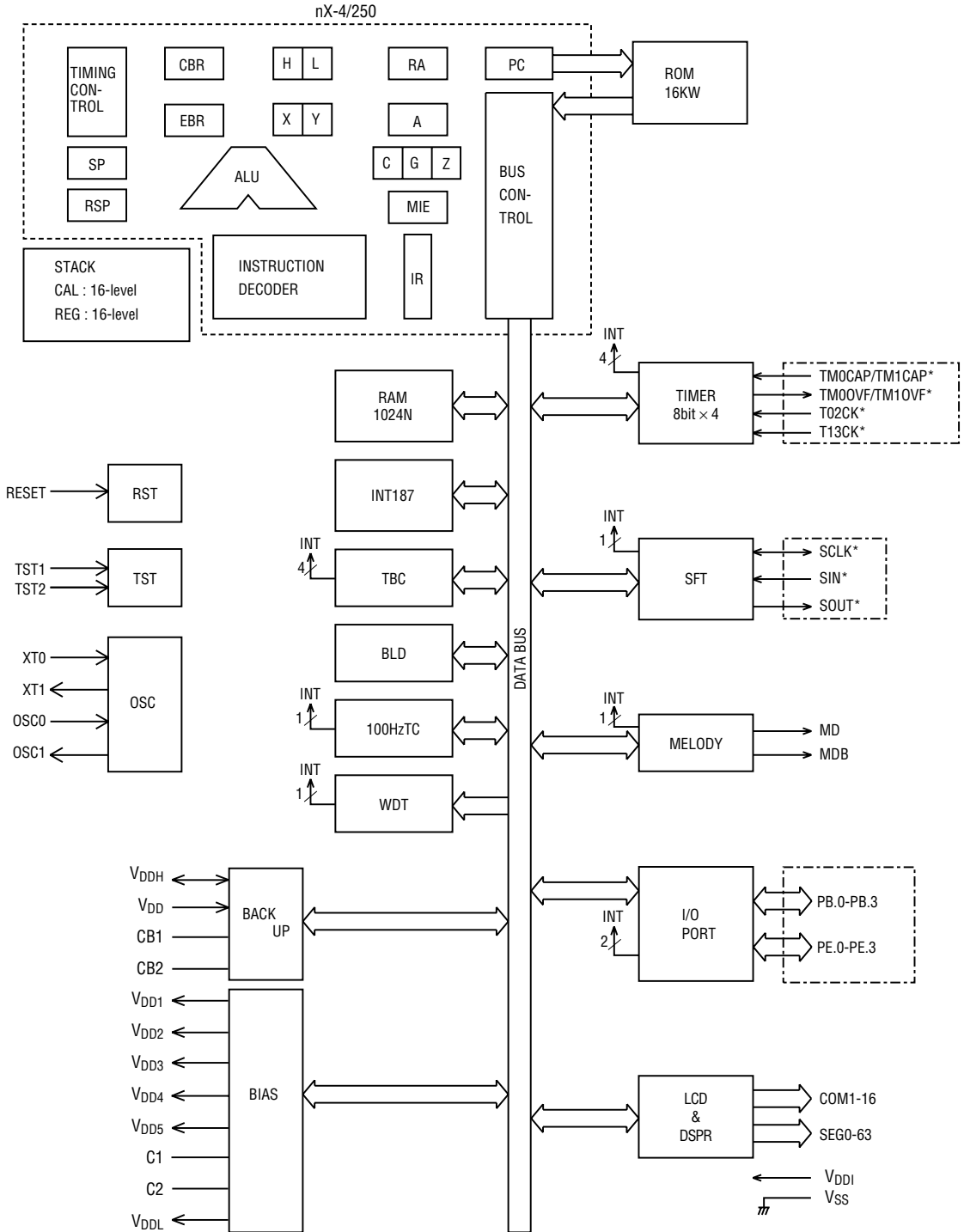
An asterisk (*) indicates the port secondary function.  indicates that the power is supplied to the circuits corresponding to the signal names inside  from V_{DDI} (power supply for interface).



BLOCK DIAGRAM (ML63189B)

An asterisk (*) indicates the port secondary function.  indicates that the power is supplied to the circuits corresponding to the signal names inside  from V_{DDI} (power supply for interface).

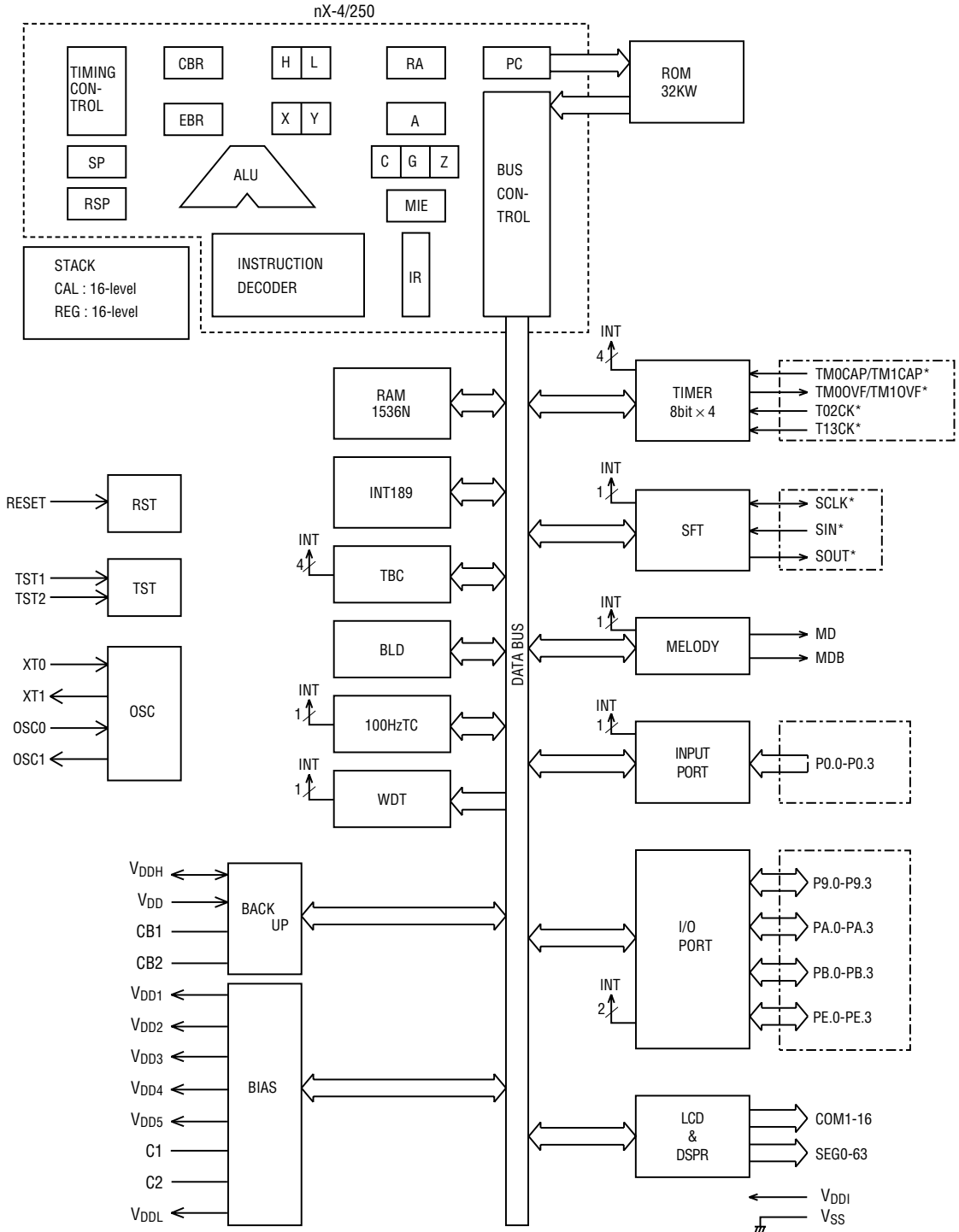

PIN CONFIGURATION (TOP VIEW) (ML63187)

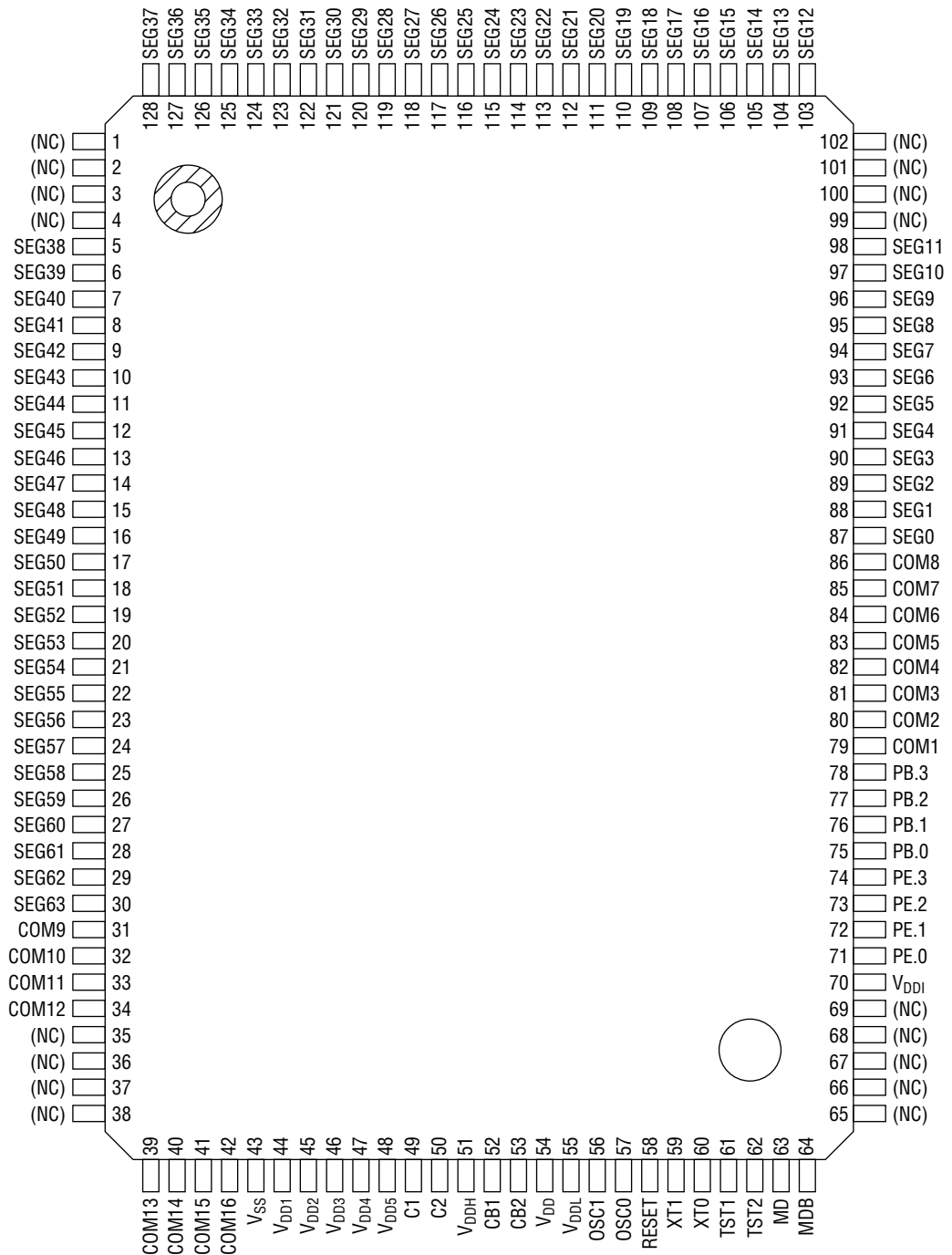

128-Pin Plastic QFP

Note: Pins marked as (NC) are no-connection pins which are left open.

PAD CONFIGURATION (ML63187)

Pad Layout

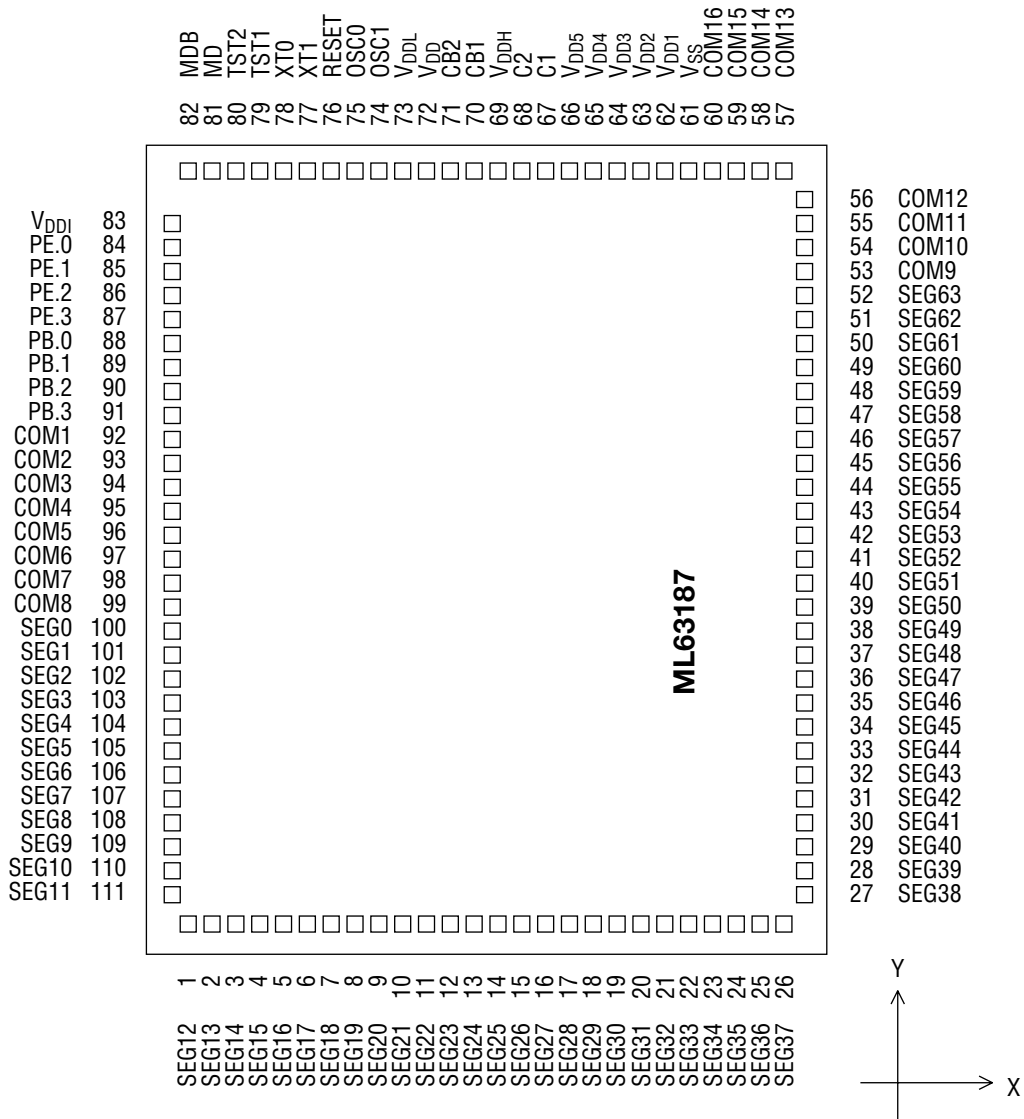

- Chip size : 4.238 mm × 4.914 mm
- Chip thickness : 350 μm (280 μm: available as required)
- Coordinate origin : center of chip
- Pad hole size : 100 μm × 100 μm
- Pad size : 110 μm × 110 μm
- Minimum pad pitch : 140 μm

Note: The chip substrate voltage is V_{SS}.

Pad Coordinates (ML63187)

Pad No.	Pad Name	X (μm)	Y (μm)	Pad No.	Pad Name	X (μm)	Y (μm)	Pad No.	Pad Name	X (μm)	Y (μm)
1	SEG12	-1755	-2311	42	SEG53	1969	70	83	V _{DDI}	-1969	1895
2	SEG13	-1615	-2311	43	SEG54	1969	211	84	PE.0	-1969	1755
3	SEG14	-1474	-2311	44	SEG55	1969	351	85	PE.1	-1969	1615
4	SEG15	-1334	-2311	45	SEG56	1969	491	86	PE.2	-1969	1474
5	SEG16	-1193	-2311	46	SEG57	1969	632	87	PE.3	-1969	1334
6	SEG17	-1053	-2311	47	SEG58	1969	772	88	PB.0	-1969	1193
7	SEG18	-913	-2311	48	SEG59	1969	913	89	PB.1	-1969	1053
8	SEG19	-772	-2311	49	SEG60	1969	1053	90	PB.2	-1969	913
9	SEG20	-632	-2311	50	SEG61	1969	1193	91	PB.3	-1969	772
10	SEG21	-491	-2311	51	SEG62	1969	1334	92	COM1	-1969	632
11	SEG22	-351	-2311	52	SEG63	1969	1474	93	COM2	-1969	491
12	SEG23	-211	-2311	53	COM9	1969	1615	94	COM3	-1969	351
13	SEG24	-70	-2311	54	COM10	1969	1755	95	COM4	-1969	211
14	SEG25	70	-2311	55	COM11	1969	1895	96	COM5	-1969	70
15	SEG26	211	-2311	56	COM12	1969	2036	97	COM6	-1969	-70
16	SEG27	351	-2311	57	COM13	1755	2311	98	COM7	-1969	-211
17	SEG28	491	-2311	58	COM14	1615	2311	99	COM8	-1969	-351
18	SEG29	632	-2311	59	COM15	1474	2311	100	SEG0	-1969	-491
19	SEG30	772	-2311	60	COM16	1334	2311	101	SEG1	-1969	-632
20	SEG31	913	-2311	61	V _{SS}	1193	2311	102	SEG2	-1969	-772
21	SEG32	1053	-2311	62	V _{DD1}	1053	2311	103	SEG3	-1969	-913
22	SEG33	1193	-2311	63	V _{DD2}	913	2311	104	SEG4	-1969	-1053
23	SEG34	1334	-2311	64	V _{DD3}	772	2311	105	SEG5	-1969	-1193
24	SEG35	1474	-2311	65	V _{DD4}	632	2311	106	SEG6	-1969	-1334
25	SEG36	1615	-2311	66	V _{DD5}	491	2311	107	SEG7	-1969	-1474
26	SEG37	1755	-2311	67	C1	351	2311	108	SEG8	-1969	-1615
27	SEG38	1969	-2036	68	C2	211	2311	109	SEG9	-1969	-1755
28	SEG39	1969	-1895	69	V _{DDH}	70	2311	110	SEG10	-1969	-1895
29	SEG40	1969	-1755	70	CB1	-70	2311	111	SEG11	-1969	-2036
30	SEG41	1969	-1615	71	CB2	-211	2311				
31	SEG42	1969	-1474	72	V _{DD}	-351	2311				
32	SEG43	1969	-1334	73	V _{DDL}	-491	2311				
33	SEG44	1969	-1193	74	OSC1	-632	2311				
34	SEG45	1969	-1053	75	OSC0	-772	2311				
35	SEG46	1969	-913	76	RESET	-913	2311				
36	SEG47	1969	-772	77	XT1	-1053	2311				
37	SEG48	1969	-632	78	XT0	-1193	2311				
38	SEG49	1969	-491	79	TST1	-1334	2311				
39	SEG50	1969	-351	80	TST2	-1474	2311				
40	SEG51	1969	-211	81	MD	-1615	2311				
41	SEG52	1969	-70	82	MDB	-1755	2311				

PIN CONFIGURATION (TOP VIEW) (ML63189B)

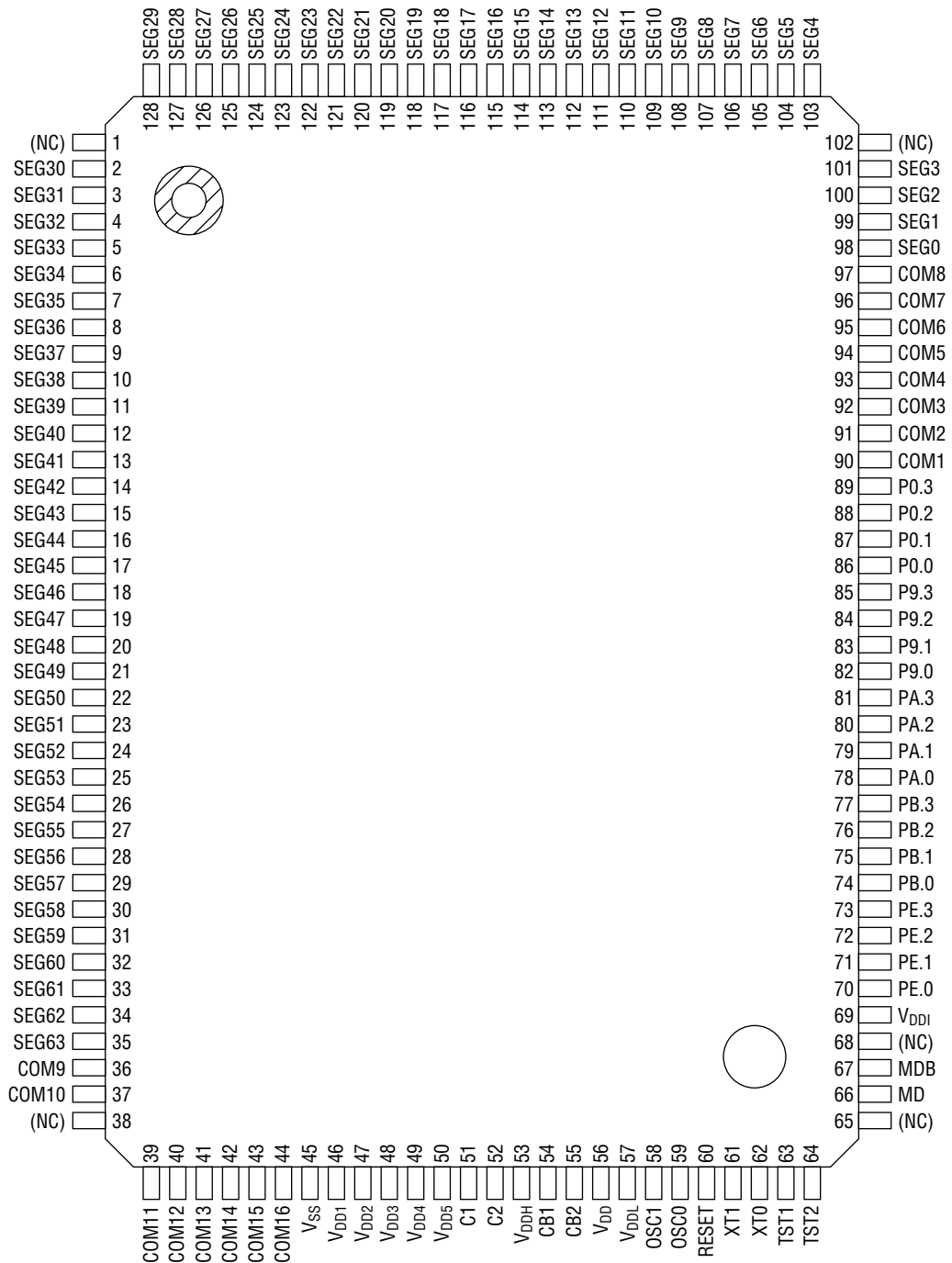

128-Pin Plastic QFP

Note: Pins marked as (NC) are no-connection pins which are left open.

PAD CONFIGURATION (ML63189B)

Pad Layout

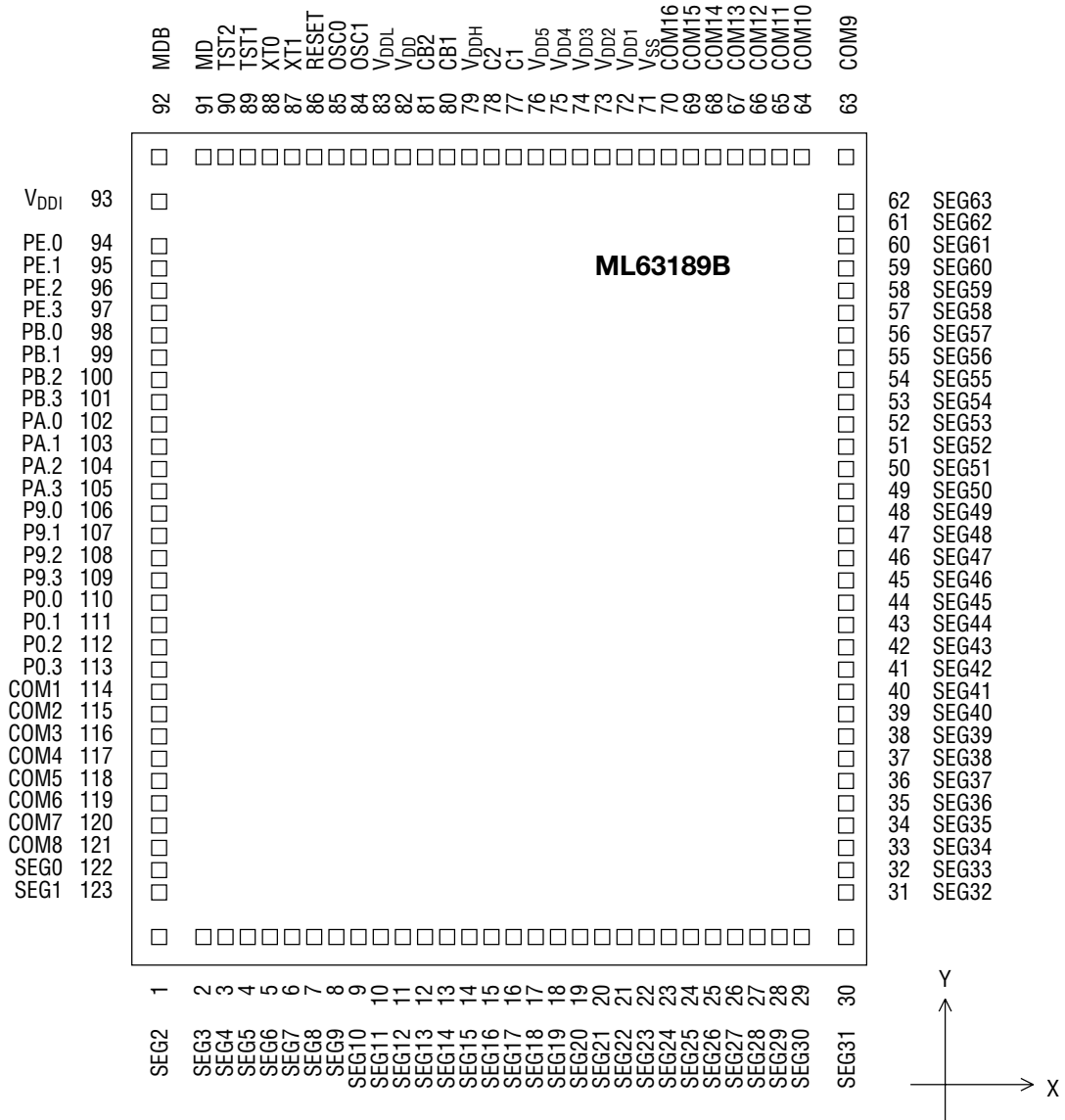

- Chip size : 4.81 mm × 5.20 mm
- Chip thickness : 350 μm (280 μm: available as required)
- Coordinate origin : center of chip
- Pad hole size : 100 μm × 100 μm
- Pad size : 110 μm × 110 μm
- Minimum pad pitch : 140 μm

Note: The chip substrate voltage is V_{SS}.

Pad Coordinates (ML63189B)

Pad No.	Pad Name	X (μm)	Y (μm)	Pad No.	Pad Name	X (μm)	Y (μm)	Pad No.	Pad Name	X (μm)	Y (μm)
1	SEG2	-2259	-2438	42	SEG43	2259	-632	83	V _{DDL}	-772	2438
2	SEG3	-1895	-2438	43	SEG44	2259	-491	84	OSC1	-913	2438
3	SEG4	-1755	-2438	44	SEG45	2259	-351	85	OSC0	-1053	2438
4	SEG5	-1615	-2438	45	SEG46	2259	-211	86	RESET	-1193	2438
5	SEG6	-1474	-2438	46	SEG47	2259	-70	87	XT1	-1334	2438
6	SEG7	-1334	-2438	47	SEG48	2259	70	88	XT0	-1474	2438
7	SEG8	-1193	-2438	48	SEG49	2259	211	89	TST1	-1615	2438
8	SEG9	-1053	-2438	49	SEG50	2259	351	90	TST2	-1775	2438
9	SEG10	-913	-2438	50	SEG51	2259	491	91	MD	-1895	2438
10	SEG11	-772	-2438	51	SEG52	2259	632	92	MDB	-2259	2438
11	SEG12	-632	-2438	52	SEG53	2259	772	93	V _{DDI}	-2259	2132
12	SEG13	-491	-2438	53	SEG54	2259	913	94	PE.0	-2259	1895
13	SEG14	-351	-2438	54	SEG55	2259	1053	95	PE.1	-2259	1755
14	SEG15	-211	-2438	55	SEG56	2259	1193	96	PE.2	-2259	1615
15	SEG16	-70	-2438	56	SEG57	2259	1334	97	PE.3	-2259	1474
16	SEG17	70	-2438	57	SEG58	2259	1474	98	PB.0	-2259	1334
17	SEG18	211	-2438	58	SEG59	2259	1615	99	PB.1	-2259	1193
18	SEG19	351	-2438	59	SEG60	2259	1755	100	PB.2	-2259	1053
19	SEG20	491	-2438	60	SEG61	2259	1895	101	PB.3	-2259	913
20	SEG21	632	-2438	61	SEG62	2259	2036	102	PA.0	-2259	772
21	SEG22	772	-2438	62	SEG63	2259	2176	103	PA.1	-2259	632
22	SEG23	913	-2438	63	COM9	2259	2438	104	PA.2	-2259	491
23	SEG24	1053	-2438	64	COM10	1895	2438	105	PA.3	-2259	351
24	SEG25	1193	-2438	65	COM11	1755	2438	106	P9.0	-2259	211
25	SEG26	1334	-2438	66	COM12	1615	2438	107	P9.1	-2259	70
26	SEG27	1474	-2438	67	COM13	1474	2438	108	P9.2	-2259	-70
27	SEG28	1615	-2438	68	COM14	1334	2438	109	P9.3	-2259	-211
28	SEG29	1755	-2438	69	COM15	1193	2438	110	P0.0	-2259	-351
29	SEG30	1895	-2438	70	COM16	1053	2438	111	P0.1	-2259	-491
30	SEG31	2259	-2438	71	V _{SS}	913	2438	112	P0.2	-2259	-632
31	SEG32	2259	-2176	72	V _{DD1}	772	2438	113	P0.3	-2259	-772
32	SEG33	2259	-2036	73	V _{DD2}	632	2438	114	COM1	-2259	-913
33	SEG34	2259	-1895	74	V _{DD3}	491	2438	115	COM2	-2259	-1053
34	SEG35	2259	-1755	75	V _{DD4}	351	2438	116	COM3	-2259	-1193
35	SEG36	2259	-1615	76	V _{DD5}	211	2438	117	COM4	-2259	-1334
36	SEG37	2259	-1474	77	C1	70	2438	118	COM5	-2259	-1474
37	SEG38	2259	-1334	78	C2	-70	2438	119	COM6	-2259	-1615
38	SEG39	2259	-1193	79	V _{DDH}	-211	2438	120	COM7	-2259	-1755
39	SEG40	2259	-1053	80	CB1	-351	2438	121	COM8	-2259	-1895
40	SEG41	2259	-913	81	CB2	-491	2438	122	SEG0	-2259	-2036
41	SEG42	2259	-772	82	V _{DD}	-632	2438	123	SEG1	-2259	-2176

PIN DESCRIPTIONS

The basic functions of each pin of the ML63187/ML63189B are described in Table 1.

A symbol with a slash (/) denotes a pin that has a secondary function.

Refer to Table 2 for secondary functions.

For type, "—" denotes a power supply pin, "I" an input pin, "O" an output pin, and "I/O" an input-output pin.

Table 1 Pin Descriptions (Basic Functions)

Function	Symbol	Pin No.		Pad No.		Type	Description
		ML63187	ML63189B	ML63187	ML63189B		
Power Supply	V _{DD}	54	56	72	82	—	Positive power supply
	V _{SS}	43	45	61	71	—	Negative power supply
	V _{DD1}	44	46	62	72	—	Power supply pins for LCD bias (internally generated). Capacitors (0.1 μF) should be connected between these pins and V _{SS} .
	V _{DD2}	45	47	63	73		
	V _{DD3}	46	48	64	74		
	V _{DD4}	47	49	65	75		
	V _{DD5}	48	50	66	76		
	C1	49	51	67	77		
	C2	50	52	68	78	—	A capacitor (0.1 μF) should be connected between C1 and C2.
	V _{DDI}	70	69	83	93	—	Positive power supply pin for external interface (power supply for input, and input-output ports)
	V _{DDL}	55	57	73	83	—	Positive power supply pin for internal logic (internally generated). A capacitor (0.1 μF) should be connected between this pin and V _{SS} .
	V _{DDH}	51	53	69	79	—	Voltage multiplier pin for power supply backup (internally generated). A capacitor (1.0 μF) should be connected between this pin and V _{SS} .
	CB1	52	54	70	80	—	Pins to connect a capacitor for voltage multiplier.
	CB2	53	55	71	81	—	A capacitor (1.0 μF) should be connected between CB1 and CB2.
Oscillation	XT0	60	62	78	88	I	Low-speed clock oscillation pins. An option for using crystal oscillation or RC oscillation is chosen by the mask option.
	XT1	59	61	77	87	O	If the crystal oscillation is chosen, a crystal should be connected between XT0 and XT1, and capacitor (C _G) should be connected between XT0 and V _{SS} . If the RC oscillation is chosen, external oscillation resistor (R _{OSL}) should be connected between XT0 and XT1.
	OSC0	57	59	75	85	I	High-speed clock oscillation pins.
	OSC1	56	58	74	84	O	A ceramic resonator and capacitors (C _{L0} , C _{L1}) or external oscillation resistor (R _{OSH}) should be connected to these pins.

Table 1 Pin Descriptions (Basic Functions) (continued)

Function	Symbol	Pin No.		Pad No.		Type	Description
		ML63187	ML63189B	ML63187	ML63189B		
Test	TST1	61	63	79	89	I	Input pins for testing. A pull-down resistor is internally connected to these pins.
	TST2	62	64	80	90	I	The user cannot use these pins.
Reset	RESET	58	60	76	86	I	Reset input pin. Setting this pin to "H" level puts this device into a reset state. Then, setting this pin to "L" level starts executing an instruction from address 0000H. A pull-down resistor is internally connected to this pin.
Melody	MD	63	66	81	91	O	Melody output pin (non-inverted output)
	MDB	64	67	82	92	O	Melody output pin (inverted output)
Port	P0.0/INT5	—	86	—	110	I	4-bit input ports. Pull-up resistor input, pull-down resistor input, or high-impedance input is selectable for each bit. Applied to the ML63189B only.
	P0.1/INT5		87		111		
	P0.2/INT5		88		112		
	P0.3/INT5		89		113		
	P9.0	—	82	—	106	I/O	4-bit input-output ports. In input mode, pull-up resistor input, pull-down resistor input, or high-impedance input is selectable for each bit.
	P9.1		83		107		
	P9.2		84		108		
	P9.3		85		109		
	PA.0	—	78	—	102	I/O	In output mode, P-channel open drain output, N-channel open drain output, CMOS output, or high-impedance output is selectable for each bit. P9.0 to P9.3 and PA.0 to PA.3 are applied to the ML63189B only.
	PA.1		79		103		
	PA.2		80		104		
	PA.3		81		105		
	PB.0/INT0/ TM0CAP/ TM0OVF	75	74	88	98	I/O	
	PB.1/INT0/ TM1CAP/ TM1OVF	76	75	89	99		
	PB.2/INT0/T02CK	77	76	90	100		
	PB.3/INT0/T13CK	78	77	91	101		
PE.0/SIN	71	70	84	94	I/O		
PE.1/SOUT	72	71	85	95			
PE.2/SCLK	73	72	86	96			
PE.3/INT2	74	73	87	97			

Table 1 Pin Descriptions (Basic Functions) (continued)

Function	Symbol	Pin No.		Pad No.		Type	Description
		ML63187	ML63189B	ML63187	ML63189B		
LCD	COM1	79	90	92	114	0	LCD common signal output pins
	COM2	80	91	93	115		
	COM3	81	92	94	116		
	COM4	82	93	95	117		
	COM5	83	94	96	118		
	COM6	84	95	97	119		
	COM7	85	96	98	120		
	COM8	86	97	99	121		
	COM9	31	36	53	63		
	COM10	32	37	54	64		
	COM11	33	39	55	65		
	COM12	34	40	56	66		
	COM13	39	41	57	67		
	COM14	40	42	58	68		
	COM15	41	43	59	69		
	COM16	42	44	60	70		
LCD	SEG0	87	98	100	122	0	LCD segment signal output pins
	SEG1	88	99	101	123		
	SEG2	89	100	102	1		
	SEG3	90	101	103	2		
	SEG4	91	103	104	3		
	SEG5	92	104	105	4		
	SEG6	93	105	106	5		
	SEG7	94	106	107	6		
	SEG8	95	107	108	7		
	SEG9	96	108	109	8		
	SEG10	97	109	110	9		
	SEG11	98	110	111	10		
	SEG12	103	111	1	11		
	SEG13	104	112	2	12		
	SEG14	105	113	3	13		
	SEG15	106	114	4	14		
	SEG16	107	115	5	15		
	SEG17	108	116	6	16		
	SEG18	109	117	7	17		
	SEG19	110	118	8	18		
	SEG20	111	119	9	19		
	SEG21	112	120	10	20		
	SEG22	113	121	11	21		
	SEG23	114	122	12	22		
SEG24	115	123	13	23			

Table 1 Pin Descriptions (Basic Functions) (continued)

Function	Symbol	Pin No.		Pad No.		Type	Description
		ML63187	ML63189B	ML63187	ML63189B		
LCD	SEG25	116	124	14	24	0	LCD segment signal output pins
	SEG26	117	125	15	25		
	SEG27	118	126	16	26		
	SEG28	119	127	17	27		
	SEG29	120	128	18	28		
	SEG30	121	2	19	29		
	SEG31	122	3	20	30		
	SEG32	123	4	21	31		
	SEG33	124	5	22	32		
	SEG34	125	6	23	33		
	SEG35	126	7	24	34		
	SEG36	127	8	25	35		
	SEG37	128	9	26	36		
	SEG38	5	10	27	37		
	SEG39	6	11	28	38		
	SEG40	7	12	29	39		
	SEG41	8	13	30	40		
	SEG42	9	14	31	41		
	SEG43	10	15	32	42		
	SEG44	11	16	33	43		
	SEG45	12	17	34	44		
	SEG46	13	18	35	45		
	SEG47	14	19	36	46		
	SEG48	15	20	37	47		
	SEG49	16	21	38	48		
	SEG50	17	22	39	49		
	SEG51	18	23	40	50		
	SEG52	19	24	41	51		
	SEG53	20	25	42	52		
	SEG54	21	26	43	53		
	SEG55	22	27	44	54		
	SEG56	23	28	45	55		
	SEG57	24	29	46	56		
SEG58	25	30	47	57			
SEG59	26	31	48	58			
SEG60	27	32	49	59			
SEG61	28	33	50	60			
SEG62	29	34	51	61			
SEG63	30	35	52	62			

Table 2 shows the secondary functions of each pin of the ML63187/ML63189B.

Table 2 Pin Descriptions (Secondary Functions)

Function	Symbol	Pin No.		Pad No.		Type	Description
		ML63187	ML63189B	ML63187	ML63189B		
External Interrupt	PB.0/INT0	75	74	88	98	I	External 0 interrupt input pins. The change of input signal level causes an interrupt to occur. The Port B Interrupt Enable register (PBIE) enables or disables an interrupt for each bit.
	PB.1/INT0	76	75	89	99		
	PB.2/INT0	77	76	90	100		
	PB.3/INT0	78	77	91	101		
	PE.3/INT2	74	73	87	97	I	External 2 interrupt input pin. The change of input signal level causes an interrupt to occur.
	P0.0/INT5	—	86	—	110	I	External 5 interrupt input pins. The change of input signal level causes an interrupt to occur. The Port 0 Interrupt Enable register (P0IE) enable or disable an interrupt for each bit. Applied to the ML63189B only.
	P0.1/INT5		87		111		
	P0.2/INT5		88		112		
P0.3/INT5	89		113				

Table 2 Pin Descriptions (Secondary Functions) (continued)

Function	Symbol	Pin No.		Pad No.		Type	Description
		ML63187	ML63189B	ML63187	ML63189B		
Capture	PB.0/TM0CAP	75	74	88	98	I	Timer 0 capture input pin.
	PB.1/TM1CAP	76	75	89	99	I	Timer 1 capture input pin.
Timer	PB.0/TM0OVF	75	74	88	98	O	Timer 0 overflow flag output pin.
	PB.1/TM1OVF	76	75	89	99	O	Timer 1 overflow flag output pin.
	PB.2/T02CK	77	76	90	100	I	External clock input pin for timer 0 and timer 2.
	PB.3/T13CK	78	77	91	101	I	External clock input pin for timer 1 and timer 3.
Shift Register	PE.0/SIN	71	70	84	94	I	Shift register receive data input pin.
	PE.1/SOUT	72	71	85	95	O	Shift register transmit data output pin.
	PE.2/SCLK	73	72	86	96	I/O	Shift register clock input-output pin.
							Clock output when this device is used as a master processor. Clock input when this device is used as a slave processor.

ABSOLUTE MAXIMUM RATINGS(V_{SS} = 0 V)

Parameter	Symbol	Condition	Rating	Unit
Power Supply Voltage 1	V _{DD1}	Ta = 25°C	-0.3 to +1.6	V
Power Supply Voltage 2	V _{DD2}	Ta = 25°C	-0.3 to +2.9	V
Power Supply Voltage 3	V _{DD3}	Ta = 25°C	-0.3 to +4.2	V
Power Supply Voltage 4	V _{DD4}	Ta = 25°C	-0.3 to +5.5	V
Power Supply Voltage 5	V _{DD5}	Ta = 25°C	-0.3 to +6.8	V
Power Supply Voltage 6	V _{DD}	Ta = 25°C	-0.3 to +6.0	V
Power Supply Voltage 7	V _{DDI}	Ta = 25°C	-0.3 to +6.0	V
Power Supply Voltage 8	V _{DDH}	Ta = 25°C	-0.3 to +6.0	V
Power Supply Voltage 9	V _{DDL}	Ta = 25°C	-0.3 to +6.0	V
Input Voltage 1	V _{IN1}	V _{DD} Input, Ta = 25°C	-0.3 to V _{DD} + 0.3	V
Input Voltage 2	V _{IN2}	V _{DDI} Input, Ta = 25°C	-0.3 to V _{DDI} + 0.3	V
Output Voltage 1	V _{OUT1}	V _{DD1} Output, Ta = 25°C	-0.3 to V _{DD1} + 0.3	V
Output Voltage 2	V _{OUT2}	V _{DD2} Output, Ta = 25°C	-0.3 to V _{DD2} + 0.3	V
Output Voltage 3	V _{OUT3}	V _{DD3} Output, Ta = 25°C	-0.3 to V _{DD3} + 0.3	V
Output Voltage 4	V _{OUT4}	V _{DD4} Output, Ta = 25°C	-0.3 to V _{DD4} + 0.3	V
Output Voltage 5	V _{OUT5}	V _{DD5} Output, Ta = 25°C	-0.3 to V _{DD5} + 0.3	V
Output Voltage 6	V _{OUT6}	V _{DD} Output, Ta = 25°C	-0.3 to V _{DD} + 0.3	V
Output Voltage 7	V _{OUT7}	V _{DDI} Output, Ta = 25°C	-0.3 to V _{DDI} + 0.3	V
Output Voltage 8	V _{OUT8}	V _{DDH} Output, Ta = 25°C	-0.3 to V _{DDH} + 0.3	V
Storage Temperature	T _{STG}	—	-55 to +150	°C

RECOMMENDED OPERATING CONDITIONS

- When backup is used

(V_{SS} = 0 V)

Parameter	Symbol	Condition	Range	Unit	
Operating Temperature	T _{op}	—	-20 to +70	°C	
Operating Voltage	V _{DD}	—	0.9 to 2.7	V	
	V _{DDI}	—	0.9 to 5.5	V	
Crystal Oscillation Frequency	f _{X_T}	C _G = 5 to 25 pF	32.768 to 76.8	kHz	
Low-speed RC Oscillation Frequency	f _{ROSL}	R _{OSL} = 1.5 MΩ	32 ±30%	kHz	
		R _{OSL} = 700 kΩ	60 ±30%		
		R _{OSL} = 500 kΩ	80 ±30%		
Ceramic Oscillation Frequency	f _{CM}	V _{DD} = 0.9 to 1.2 V	Not applied	Hz	
		V _{DD} = 1.2 to 2.7 V	300k to 500k		
		V _{DD} = 1.5 to 2.7 V	200k to 1M		
High-speed RC Oscillation Frequency	f _{ROSH}	V _{DD} = 0.9 to 1.2 V		Hz	
		V _{DD} = 1.2 to 2.7 V	R _{OSH} = 400 kΩ		200k ±30%
			R _{OSH} = 100 kΩ		700k ±30%
			R _{OSH} = 75 kΩ		1M ±30%

- When backup is not used

(V_{SS} = 0 V)

Parameter	Symbol	Condition	Range	Unit
Operating Temperature	T _{op}	—	-20 to +70	°C
Operating Voltage	V _{DD}	—	1.8 to 5.5	V
	V _{DDI}	—	1.8 to 5.5	V
Crystal Oscillation Frequency	f _{X_T}	C _G = 5 to 25 pF	32.768 to 76.8	kHz
Low-speed RC Oscillation Frequency	f _{ROSL}	R _{OSL} = 1.5 MΩ	32 ±30%	kHz
		R _{OSL} = 700 kΩ	60 ±30%	
		R _{OSL} = 500 kΩ	80 ±30%	
Ceramic Oscillation Frequency	f _{CM}	V _{DD} = 1.8 to 5.5 V	200k to 2M	Hz
High-speed RC Oscillation Frequency	f _{ROSH}	V _{DD} = 1.8 to 5.5 V	R _{OSH} = 100 kΩ	700k ±30%
			R _{OSH} = 75 kΩ	1M ±30%
			R _{OSH} = 51 kΩ	1.35M ±30%
		V _{DD} = 1.8 to 3.5 V, R _{OSH} = 30 kΩ		2M ±30%

- Typical characteristics of low-speed RC oscillation

When backup is used/backup is not used ($V_{DD} = V_{DDI} = 1.5\text{ V} / V_{DD} = V_{DDI} = 3.0\text{ V}$)

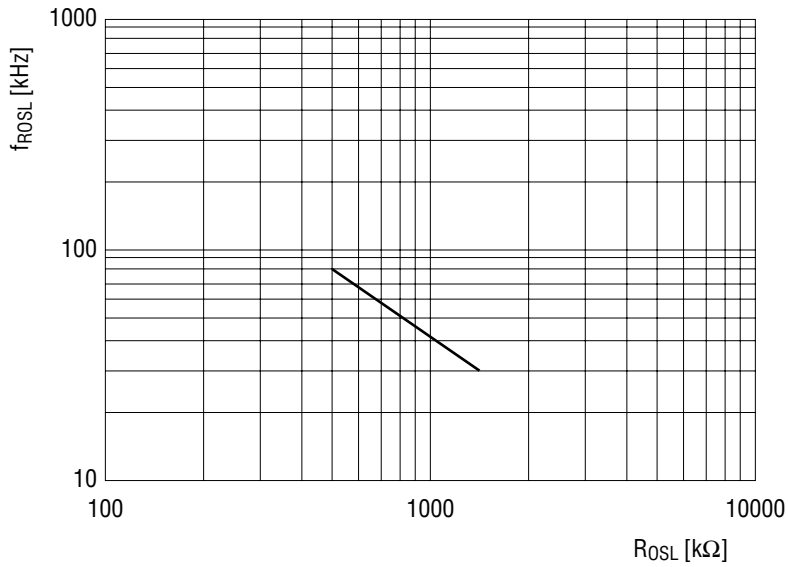

- Typical characteristics of high-speed RC oscillation

When backup is used ($V_{DD} = V_{DDI} = 1.5\text{ V}$)

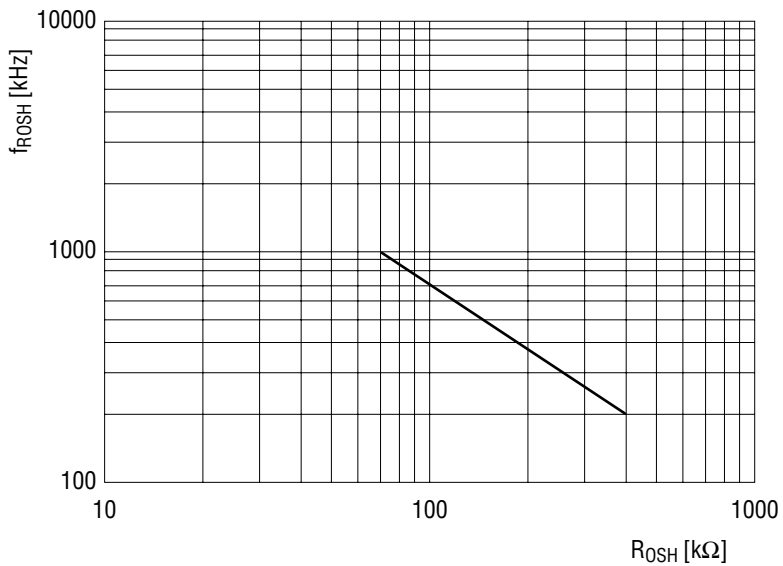

- Typical characteristics of high-speed RC oscillation
 When backup is not used ($V_{DD} = V_{DDI} = 3.0\text{ V}$)

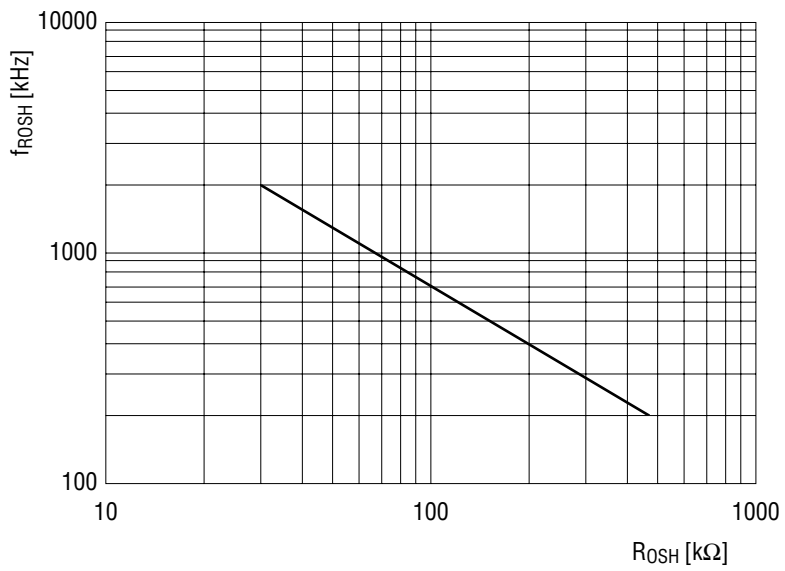

ELECTRICAL CHARACTERISTICS

DC Characteristics

($V_{DD} = V_{DD1} = 0.9$ to 5.5 V, $V_{SS} = 0$ V, $T_a = -20$ to $+70^\circ\text{C}$ unless otherwise specified)

Parameter	Symbol	Condition	Min.	Typ.	Max.	Unit	Measuring Circuit
V_{DD2} Voltage	V_{DD2}	1/5 bias, 1/4 bias ($T_a = 25^\circ\text{C}$)	1.7	1.8	1.9	V	1
V_{DD2} Voltage Temperature Deviation	ΔV_{DD2}	—	—	-4	—	mV/ $^\circ\text{C}$	
V_{DD1} Voltage	V_{DD1}	1/5 bias, 1/4 bias	Typ.- 0.1	$1/2 \times V_{DD2}$	Typ.+ 0.1	V	
V_{DD3} Voltage	V_{DD3}	1/5 bias	Typ.- 0.3	$3/2 \times V_{DD2}$	Typ.+ 0.3	V	
		1/4 bias (connect V_{DD3} and V_{DD2})	Typ.- 0.2	V_{DD2}	Typ.+ 0.2		
V_{DD4} Voltage	V_{DD4}	1/5 bias	Typ.- 0.4	$2 \times V_{DD2}$	Typ.+ 0.4	V	
		1/4 bias	Typ.- 0.3	$3/2 \times V_{DD2}$	Typ.+ 0.3		
V_{DD5} Voltage	V_{DD5}	1/5 bias	Typ.- 0.5	$5/2 \times V_{DD2}$	Typ.+ 0.5	V	
		1/4 bias	Typ.- 0.4	$2 \times V_{DD2}$	Typ.+ 0.4		
V_{DDH} Voltage (Backup used)	V_{DDH}	High-speed clock oscillation stopped $V_{DD} = 1.5$ V	2.8	—	3.0	V	
		High-speed clock oscillation (Ceramic oscillation, 1 MHz) $V_{DD} = 1.5$ V	2.0	—	2.7	V	
V_{DDL} Voltage	V_{DDL}	High-speed clock oscillation stopped	1.0	1.5	2.0	V	
		High-speed clock oscillation ($V_{DD} = 1.2$ to 5.5 V)	1.2	—	5.5	V	
Crystal Oscillation Start Voltage	V_{STA}	Oscillation start time: within 5 seconds	1.2	—	—	V	
Crystal Oscillation Hold Voltage	V_{HOLD}	Backup	0.9	—	—	V	
		Backup not used	1.7	—	—	V	
Crystal Oscillation Stop Detect Time	T_{STOP}	—	0.1	—	5.0	ms	
External Crystal Oscillator Capacitance	C_G	—	5	—	25	pF	
Internal Crystal Oscillator Capacitance	C_D	—	20	25	30	pF	
External Ceramic Oscillator Capacitance	$C_{L0, 1}$	CSA2.00MG (Murata MFG.-make) used $V_{DD} = 3.0$ V	—	30	—	pF	
Internal RC Oscillator Capacitance	C_{OS}	—	8	12	16	pF	
POR Voltage	V_{POR1}	$V_{DD} = 1.5$ V	0.0	—	0.4	V	
		$V_{DD} = 3.0$ V	0.0	—	0.7	V	
Non-POR Voltage	V_{POR2}	$V_{DD} = 1.5$ V	1.2	—	1.5	V	
		$V_{DD} = 3.0$ V	2.0	—	3.0	V	
BLD Judgment Voltage	V_{BLDC}	LD1 = 1, LD0 = 1, $T_a = 25^\circ\text{C}$	2.30	2.40	2.50	V	
		LD1 = 1, LD0 = 0, $T_a = 25^\circ\text{C}$	1.70	1.80	1.90		
		LD1 = 0, LD0 = 1, $T_a = 25^\circ\text{C}$	1.10	1.20	1.30		
		LD1 = 0, LD0 = 0, $T_a = 25^\circ\text{C}$	0.95	1.05	1.15		
BLD Judgment Voltage Temperature Deviation	ΔV_{BLDC}	$V_{BLDC} = 2.40$ V (LD1 = 1, LD0 = 1)	—	-3.5	—	mV/ $^\circ\text{C}$	
		$V_{BLDC} = 1.80$ V (LD1 = 1, LD0 = 0)	—	-2.3	—		
		$V_{BLDC} = 1.20$ V (LD1 = 0, LD0 = 1)	—	-1.6	—		
		$V_{BLDC} = 1.05$ V (LD1 = 0, LD0 = 0)	—	-1.2	—		

- Notes:
1. " T_{STOP} " indicates that if the crystal oscillator stops over the value of T_{STOP} , the system reset occurs.
 2. "POR" denotes Power On Reset.
 3. " V_{POR1} " indicates that POR occurs when V_{DD} falls from V_{DD} to V_{POR1} and again rises up to V_{DD} .
 4. " V_{POR2} " indicates that POR does not occur when V_{DD} falls from V_{DD} to V_{POR2} and again rises up to V_{DD} .

DC Characteristics (continued)

- When backup is used

($V_{DD} = V_{DD1} = 1.5\text{ V}$, $V_{SS} = 0\text{ V}$, 1/5 bias, $T_a = -20\text{ to }+70^\circ\text{C}$ unless otherwise specified)

Parameter	Symbol	Condition	Min.	Typ.	Max.	Unit	Measuring Circuit	
Supply Current 1	I_{DD1}	CPU is in HALT state. (High-speed clock oscillation stopped)	$T_a = -20\text{ to }+50^\circ\text{C}$	—	5	6.5	μA	1
			$T_a = -20\text{ to }+70^\circ\text{C}$	—	5	10		
Supply Current 2	I_{DD2}	CPU is in HALT state. LCD is in Power Down mode. (High-speed clock oscillation stopped)	$T_a = -20\text{ to }+50^\circ\text{C}$	—	4	5	μA	
			$T_a = -20\text{ to }+70^\circ\text{C}$	—	4	8		
Supply Current 3	I_{DD3}	CPU is in operation at low-speed oscillation. (High-speed clock oscillation stopped)	$T_a = -20\text{ to }+50^\circ\text{C}$	—	16	18	μA	
			$T_a = -20\text{ to }+70^\circ\text{C}$	—	16	20		
Supply Current 4	I_{DD4}	CPU is in operation at high-speed oscillation (RC oscillation, $R_{OSH} = 100\text{ k}\Omega$)	—	800	1000	μA		
Supply Current 5	I_{DD5}	CPU is in operation at high-speed oscillation (Ceramic oscillation, 1 MHz)	—	700	850	μA		

- When backup is not used

($V_{DD} = V_{DD1} = 3.0\text{ V}$, $V_{SS} = 0\text{ V}$, 1/5 bias, $T_a = -20\text{ to }+70^\circ\text{C}$ unless otherwise specified)

Parameter	Symbol	Condition	Min.	Typ.	Max.	Unit	Measuring Circuit	
Supply Current 1	I_{DD1}	CPU is in HALT state. (High-speed clock oscillation stopped)	$T_a = -20\text{ to }+50^\circ\text{C}$	—	2.2	3	μA	1
			$T_a = -20\text{ to }+70^\circ\text{C}$	—	2.2	5		
Supply Current 2	I_{DD2}	CPU is in HALT state. LCD is in Power Down mode. (High-speed clock oscillation stopped)	$T_a = -20\text{ to }+50^\circ\text{C}$	—	1.8	2.5	μA	
			$T_a = -20\text{ to }+70^\circ\text{C}$	—	1.8	4		
Supply Current 3	I_{DD3}	CPU is in operation at low-speed oscillation. (High-speed clock oscillation stopped)	$T_a = -20\text{ to }+50^\circ\text{C}$	—	7.5	9	μA	
			$T_a = -20\text{ to }+70^\circ\text{C}$	—	7.5	12		
Supply Current 4	I_{DD4}	CPU is in operation at high-speed oscillation (RC oscillation, $R_{OSH} = 100\text{ k}\Omega$)	—	550	700	μA		
Supply Current 5	I_{DD5}	CPU is in operation at high-speed oscillation (Ceramic oscillation, 2 MHz)	—	850	1000	μA		

DC Characteristics (continued)

($V_{DD} = V_{DD1} = V_{DDH} = 3.0\text{ V}$, $V_{DD1} = 1.1\text{ V}$, $V_{DD2} = 2.2\text{ V}$, $V_{DD3} = 3.3\text{ V}$, $V_{DD4} = 4.4\text{ V}$, $V_{DD5} = 5.5\text{ V}$, $T_a = -20\text{ to }+70^\circ\text{C}$ unless otherwise specified)

Parameter	Symbol	Condition	Min.	Typ.	Max.	Unit	Measuring Circuit	
Output Current 1 (P9.0 to P9.3)* (PA.0 to PA.3)* (PB.0 to PB.3) (PE.0 to PE.3)	I _{OH1}	V _{OH1} = V _{DD1} - 0.5 V	V _{DD1} = 1.5 V	-2.5	-1.4	-0.4	mA	2
			V _{DD1} = 3.0 V	-6.0	-3.5	-1.0	mA	
			V _{DD1} = 5.0 V	-8.5	-5.0	-1.5	mA	
	I _{OL1}	V _{OL1} = 0.5 V	V _{DD1} = 1.5 V	0.4	1.4	2.5	mA	
			V _{DD1} = 3.0 V	1.0	3.0	6.0	mA	
			V _{DD1} = 5.0 V	1.5	3.7	8.5	mA	
Output Current 2 (MD, MDB)	I _{OH2}	V _{OH2} = V _{DD} - 0.7 V	V _{DD} = 1.5 V	-4.0	-2.0	-0.5	mA	
			V _{DD} = 3.0 V	-11.0	-6.0	-2.0	mA	
			V _{DD} = V _{DDH} = 5.0 V	-14.0	-9.0	-4.0	mA	
	I _{OL2}	V _{OL2} = 0.7 V	V _{DD} = 1.5 V	0.5	2.0	4.0	mA	
			V _{DD} = 3.0 V	2.0	5.5	11.0	mA	
			V _{DD} = V _{DDH} = 5.0 V	4.0	7.0	14.0	mA	
Output Current 3 (SEG0 to SEG63) (COM1 to COM16)	I _{OH3}	V _{OH3} = V _{DD5} - 0.2 V (V _{DD5} level)	—	—	-4	μA		
	I _{OHM3}	V _{OHM3} = V _{DD4} + 0.2 V (V _{DD4} level)	4	—	—	μA		
	I _{OHM3S}	V _{OHM3S} = V _{DD4} - 0.2 V (V _{DD4} level)	—	—	-4	μA		
	I _{OMH3}	V _{OMH3} = V _{DD3} + 0.2 V (V _{DD3} level)	4	—	—	μA		
	I _{OMH3S}	V _{OMH3S} = V _{DD3} - 0.2 V (V _{DD3} level)	—	—	-4	μA		
	I _{OML3}	V _{OML3} = V _{DD2} + 0.2 V (V _{DD2} level)	4	—	—	μA		
	I _{OML3S}	V _{OML3S} = V _{DD2} - 0.2 V (V _{DD2} level)	—	—	-4	μA		
	I _{OLM3}	V _{OLM3} = V _{DD1} + 0.2 V (V _{DD1} level)	4	—	—	μA		
	I _{OLM3S}	V _{OLM3S} = V _{DD1} - 0.2 V (V _{DD1} level)	—	—	-4	μA		
I _{OL3}	V _{OL3} = V _{SS} + 0.2 V (V _{SS} level)	4	—	—	μA			
Output Current 4 (OSC1)	I _{OH4R}	V _{OH4R} = V _{DDH} - 0.5 V (RC oscillation)	V _{DD} = V _{DDH} = 3.0 V	-2.5	-1.3	-0.25	mA	
			V _{DD} = V _{DDH} = 5.0 V	-3.5	-1.7	-0.5	mA	
	I _{OL4R}	V _{OL4R} = 0.5 V (RC oscillation)	V _{DD} = V _{DDH} = 3.0 V	0.25	1.5	2.5	mA	
			V _{DD} = V _{DDH} = 5.0 V	0.5	1.8	3.5	mA	
	I _{OH4C}	V _{OH4C} = V _{DDH} - 0.5 V (ceramic oscillation)	V _{DD} = V _{DDH} = 3.0 V	-500	-250	-100	μA	
			V _{DD} = V _{DDH} = 5.0 V	-800	-350	-200	μA	
	I _{OL4C}	V _{OL4C} = 0.5 V (ceramic oscillation)	V _{DD} = V _{DDH} = 3.0 V	200	500	800	μA	
			V _{DD} = V _{DDH} = 5.0 V	400	700	1000	μA	
Output Leakage Current (P9.0 to P9.3)* (PA.0 to PA.3)* (PB.0 to PB.3) (PE.0 to PE.3)	I _{OOH}	V _{OH} = V _{DD1}	—	—	0.3	μA		
	I _{OOL}	V _{OL} = V _{SS}	-0.3	—	—	μA		

*: Applied to the ML63189B only.

DC Characteristics (continued)

($V_{DD} = V_{DD1} = V_{DDH} = 3.0\text{ V}$, $V_{DD1} = 1.1\text{ V}$, $V_{DD2} = 2.2\text{ V}$, $V_{DD3} = 3.3\text{ V}$, $V_{DD4} = 4.4\text{ V}$, $V_{DD5} = 5.5\text{ V}$, $T_a = -20\text{ to }+70^\circ\text{C}$ unless otherwise specified)

Parameter	Symbol	Condition	Min.	Typ.	Max.	Unit	Measuring Circuit
Input Current 1 (P0.0 to P0.3)* (P9.0 to P9.3)* (PA.0 to PA.3)* (PB.0 to PB.3) (PE.0 to PE.3)	I_{IH1}	$V_{IH1} = V_{DD1}$ (when pulled down)	$V_{DD1} = 1.5\text{ V}$	2	20	45	μA
			$V_{DD1} = 3.0\text{ V}$	30	120	260	μA
			$V_{DD1} = 5.0\text{ V}$	70	350	650	μA
	I_{IL1}	$V_{IL1} = V_{SS}$ (when pulled up)	$V_{DD1} = 1.5\text{ V}$	-45	-20	-2	μA
			$V_{DD1} = 3.0\text{ V}$	-260	-120	-30	μA
			$V_{DD1} = 5.0\text{ V}$	-650	-350	-70	μA
	I_{IH1Z}	$V_{IH1} = V_{DD1}$ (in a high impedance state)	0.0	—	1.0	μA	
I_{IL1Z}	$V_{IL1} = V_{SS}$ (in a high impedance state)	-1.0	—	0.0	μA		
Input Current 2 (OSCO)	I_{IL2}	$V_{IL2} = V_{SS}$ (when pulled up)	$V_{DD} = V_{DDH} = 3.0\text{ V}$	-350	-170	-30	μA
			$V_{DD} = V_{DDH} = 5.0\text{ V}$	-750	-450	-200	μA
	I_{IH2R}	$V_{IH2R} = V_{DDH}$ (RC oscillation)	0.0	—	1.0	μA	
	I_{IL2R}	$V_{IL2R} = V_{SS}$ (RC oscillation)	-1.0	—	0.0	μA	
	I_{IH2C}	$V_{IH2C} = V_{DDH}$ (ceramic oscillation)	$V_{DD} = V_{DDH} = 3.0\text{ V}$	0.5	1.8	4.0	μA
			$V_{DD} = V_{DDH} = 5.0\text{ V}$	3	6	10	μA
	I_{IL2C}	$V_{IL2C} = V_{SS}$ (ceramic oscillation)	$V_{DD} = V_{DDH} = 3.0\text{ V}$	-4.0	-1.8	-0.5	μA
$V_{DD} = V_{DDH} = 5.0\text{ V}$			-10	-6	-3	μA	
Input Current 3 (RESET)	I_{IH3}	$V_{IH3} = V_{DD}$	$V_{DD} = 1.5\text{ V}$	10	180	350	μA
			$V_{DD} = 3.0\text{ V}$	150	1100	2400	μA
			$V_{DD} = V_{DDH} = 5.0\text{ V}$	0.5	2.7	5.0	mA
	I_{IL3}	$V_{IL3} = V_{SS}$	-1.0	—	0.0	μA	
Input Current 4 (TST1, TST2)	I_{IH4}	$V_{IH4} = V_{DD}$	$V_{DD} = 1.5\text{ V}$	50	750	1500	μA
			$V_{DD} = 3.0\text{ V}$	0.5	3.0	5.5	mA
			$V_{DD} = V_{DDH} = 5.0\text{ V}$	2.0	6.5	11.0	mA
	I_{IL4}	$V_{IL4} = V_{SS}$	-1.0	—	0.0	μA	

3

*: Applied to the ML63189B only.

DC Characteristics (continued)

($V_{DD} = V_{DD1} = V_{DDH} = 3.0\text{ V}$, $V_{DD1} = 1.1\text{ V}$, $V_{DD2} = 2.2\text{ V}$, $V_{DD3} = 3.3\text{ V}$, $V_{DD4} = 4.4\text{ V}$, $V_{DD5} = 5.5\text{ V}$, $T_a = -20\text{ to }+70^\circ\text{C}$ unless otherwise specified)

Parameter	Symbol	Condition	Min.	Typ.	Max.	Unit	Measuring Circuit
Input Voltage 1 (P0.0 to P0.3)* (P9.0 to P9.3)* (PA.0 to PA.3)* (PB.0 to PB.3) (PE.0 to PE.3)	V_{IH1}	$V_{DD1} = 1.5\text{ V}$	1.2	—	1.5	V	4
		$V_{DD1} = 3.0\text{ V}$	2.4	—	3.0	V	
		$V_{DD1} = 5.0\text{ V}$	4.0	—	5.0	V	
	V_{IL1}	$V_{DD1} = 1.5\text{ V}$	0.0	—	0.3	V	
		$V_{DD1} = 3.0\text{ V}$	0.0	—	0.6	V	
		$V_{DD1} = 5.0\text{ V}$	0.0	—	1.0	V	
Input Voltage 2 (OSCO)	V_{IH2}	$V_{DD} = V_{DDH} = 3.0\text{ V}$	2.4	—	3.0	V	
		$V_{DD} = V_{DDH} = 5.0\text{ V}$	4.0	—	5.0	V	
	V_{IL2}	$V_{DD} = V_{DDH} = 3.0\text{ V}$	0.0	—	0.6	V	
		$V_{DD} = V_{DDH} = 5.0\text{ V}$	0.0	—	1.0	V	
Input Voltage 3 (RESET, TST1, TST2)	V_{IH3}	$V_{DD} = 1.5\text{ V}$	1.35	—	1.5	V	
		$V_{DD} = 3.0\text{ V}$	2.4	—	3.0	V	
		$V_{DD} = 5.0\text{ V}$	4.0	—	5.0	V	
	V_{IL3}	$V_{DD} = 1.5\text{ V}$	0.0	—	0.15	V	
		$V_{DD} = 3.0\text{ V}$	0.0	—	0.6	V	
		$V_{DD} = 5.0\text{ V}$	0.0	—	1.0	V	
Hysteresis Width 1 (P0.0 to P0.3)* (P9.0 to P9.3)* (PA.0 to PA.3)* (PB.0 to PB.3) (PE.0 to PE.3)	ΔV_{T1}	$V_{DD1} = 1.5\text{ V}$	0.05	0.1	0.3	V	
		$V_{DD1} = 3.0\text{ V}$	0.2	0.5	1.0	V	
		$V_{DD1} = 5.0\text{ V}$	0.25	1.0	1.5	V	
Hysteresis Width 2 (RESET, TST1, TST2)	ΔV_{T2}	$V_{DD} = 1.5\text{ V}$	0.05	0.1	0.3	V	
		$V_{DD} = 3.0\text{ V}$	0.2	0.5	1.0	V	
		$V_{DD} = 5.0\text{ V}$	0.25	1.0	1.5	V	
Input Pin Capacitance (P0.0 to P0.3)* (P9.0 to P9.3)* (PA.0 to PA.3)* (PB.0 to PB.3) (PE.0 to PE.3)	C_{IN}	—	—	—	5	pF	1

*: Applied to the ML63189B only.

Measuring circuit 1

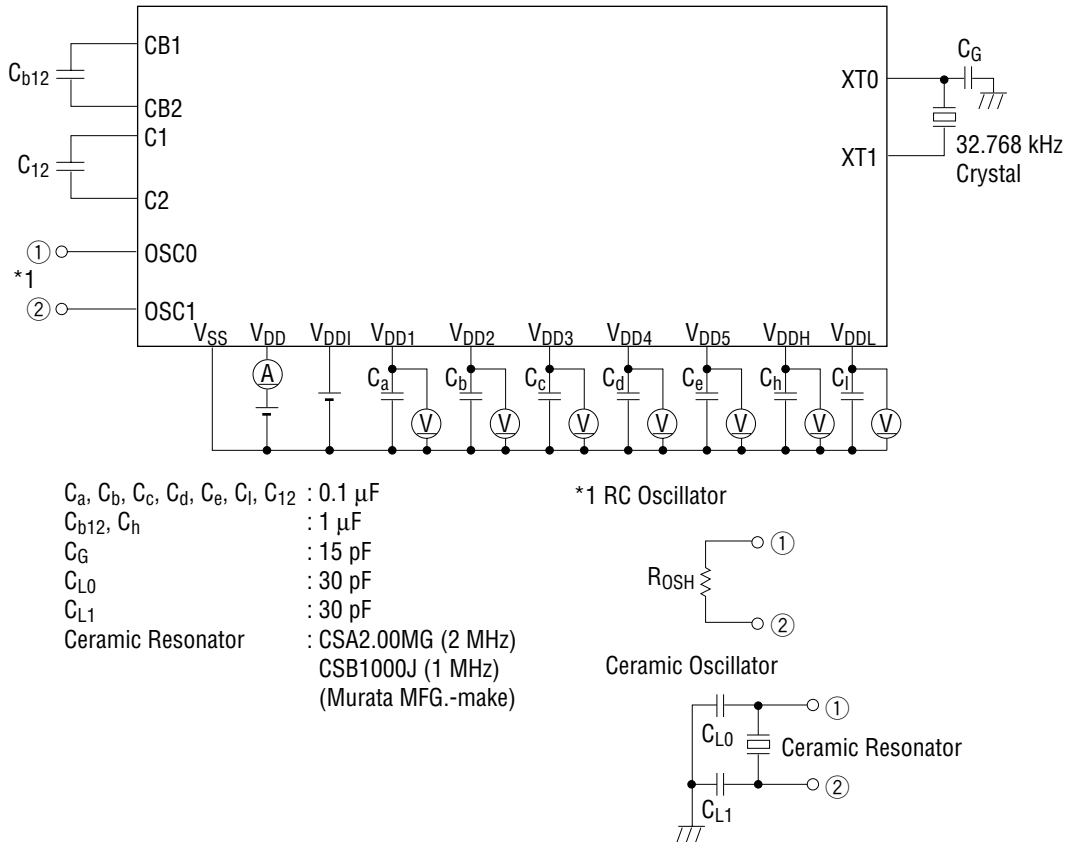

Measuring circuit 2

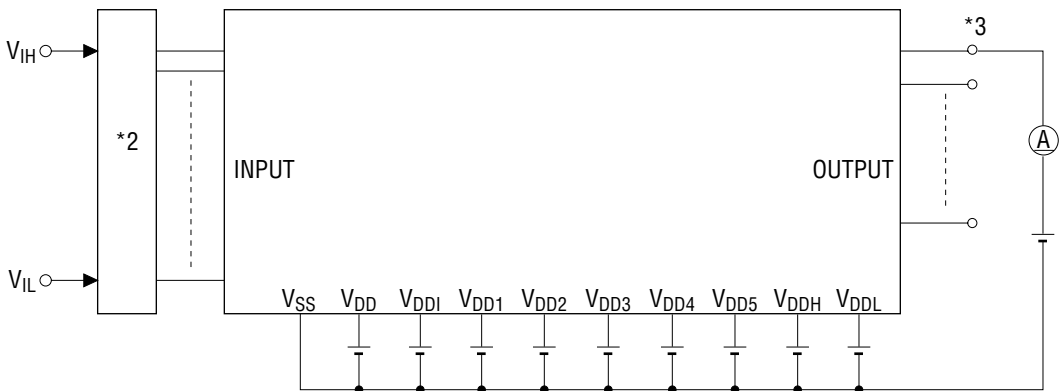

*2 Input logic circuit to determine the specified measuring conditions.

*3 Measured at the specified output pins.

Measuring circuit 3

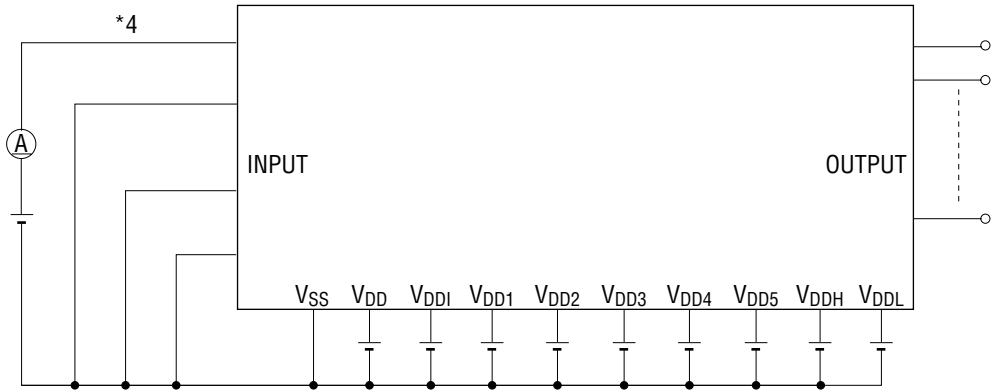

Measuring circuit 4

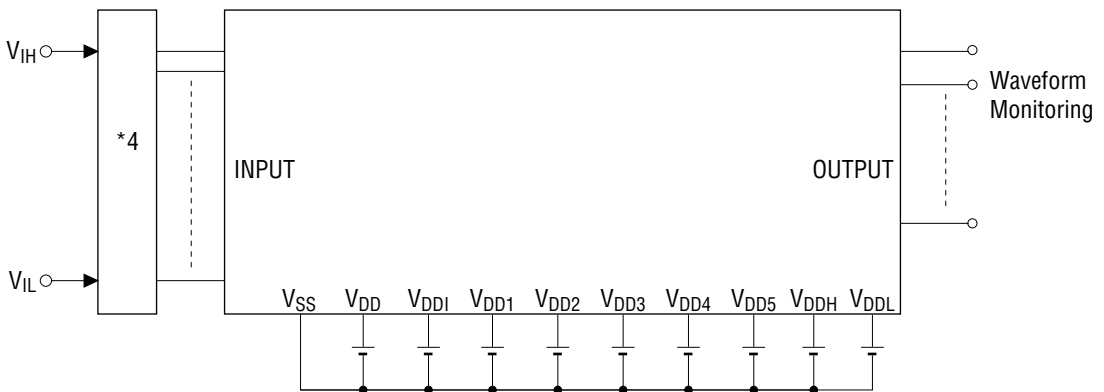

*4 Measured at the specified input pins.

AC Characteristics (Serial Interface, Shift Register)

($V_{DD} = 0.9$ to 5.5 V, $V_{DDH} = 1.8$ to 5.5 V, $V_{SS} = 0$ V, $V_{DDI} = 5.0$ V, $T_a = -20$ to $+70^\circ\text{C}$ unless otherwise specified)

Parameter	Symbol	Condition	Min.	Typ.	Max.	Unit
SCLK Input Fall Time	t_f	—	—	—	1.0	μs
SCLK Input Rise Time	t_r	—	—	—	1.0	μs
SCLK Input "L" Level Pulse Width	t_{CWL}	—	0.8	—	—	μs
SCLK Input "H" Level Pulse Width	t_{CWH}	—	0.8	—	—	μs
SCLK Input Cycle Time	t_{CYC}	$V_{DDI} = 5$ V to V_{DD}	1.8	—	—	μs
SCLK Output Cycle Time	$t_{CYC1(O)}$	CPU in operation state at 32.768 kHz	—	30.5	—	μs
	$t_{CYC2(O)}$	CPU in operation at 2 MHz $V_{DD} = V_{DDH} = 1.8$ V to 3.5 V	—	0.5	—	μs
SOUT Output Delay Time	t_{DDR}	$C_l = 10$ pF	—	—	0.4	μs
SIN Input Setup Time	t_{DS}	—	0.5	—	—	μs
SIN Input Hold Time	t_{DH}	—	0.8	—	—	μs

AC characteristics timing

("H" level = 4.0 V, "L" level = 1.0 V)

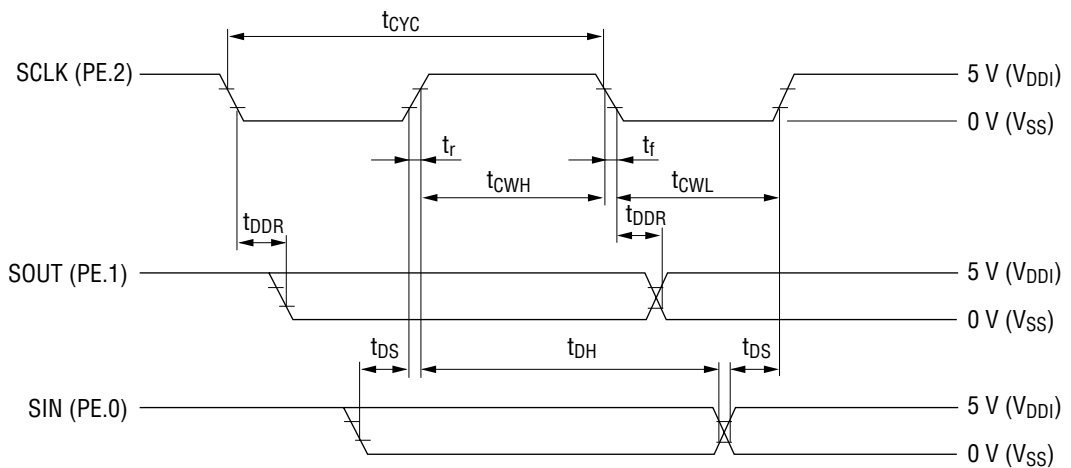

APPLICATION CIRCUITS (ML63187)

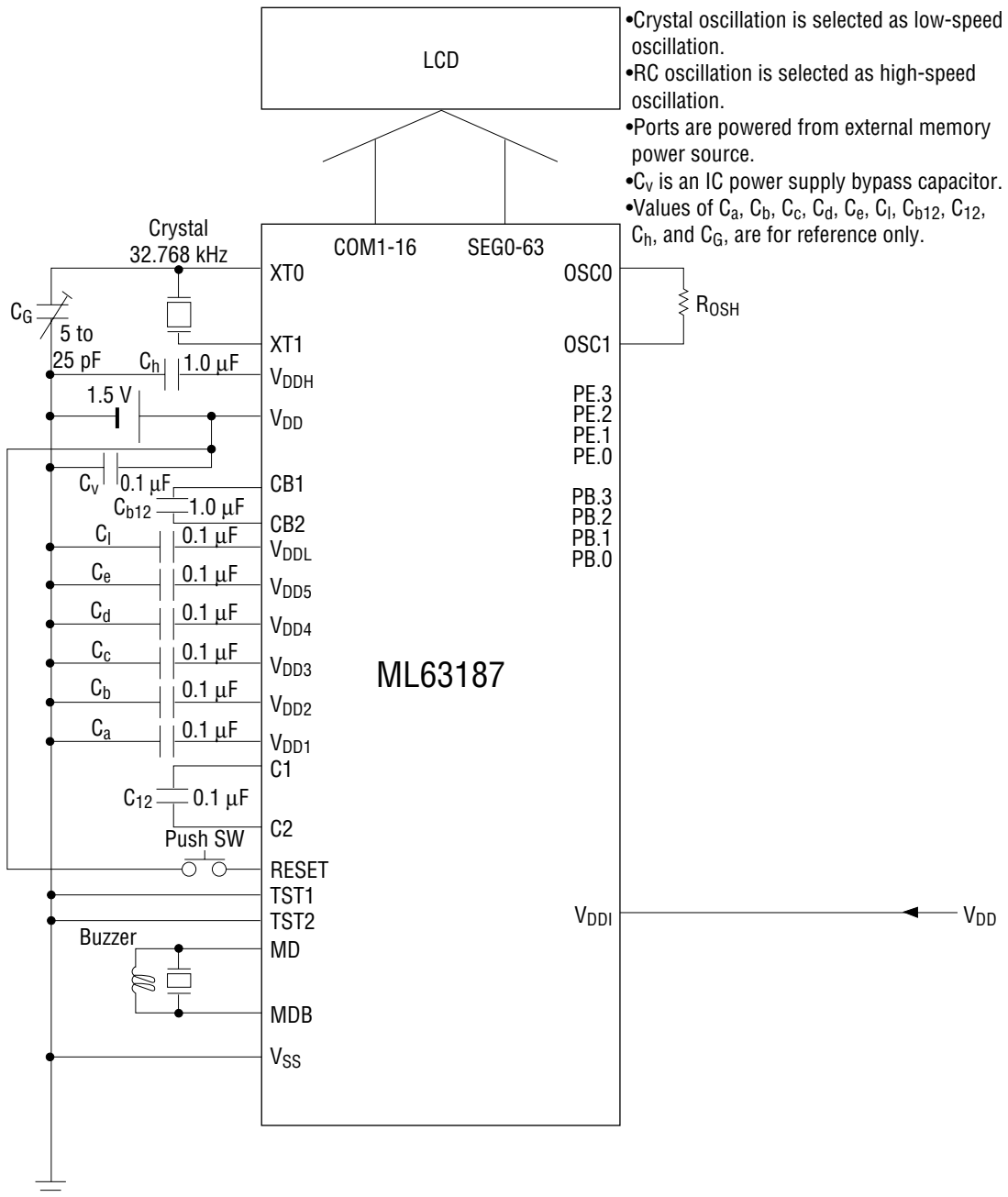

- Crystal oscillation is selected as low-speed oscillation.
- RC oscillation is selected as high-speed oscillation.
- Ports are powered from external memory power source.
- C_v is an IC power supply bypass capacitor.
- Values of C_a , C_b , C_c , C_d , C_e , C_l , C_{b12} , C_{12} , C_h , and C_G , are for reference only.

Note: V_{DDI} is the power supply pin for the input-output ports. Be sure to connect the V_{DDI} pin either to the positive power supply pin (V_{DD}) of this device or to the positive power supply pin of the external memory.

Application Circuit Example with Power Supply Backup

APPLICATION CIRCUITS (ML63187)

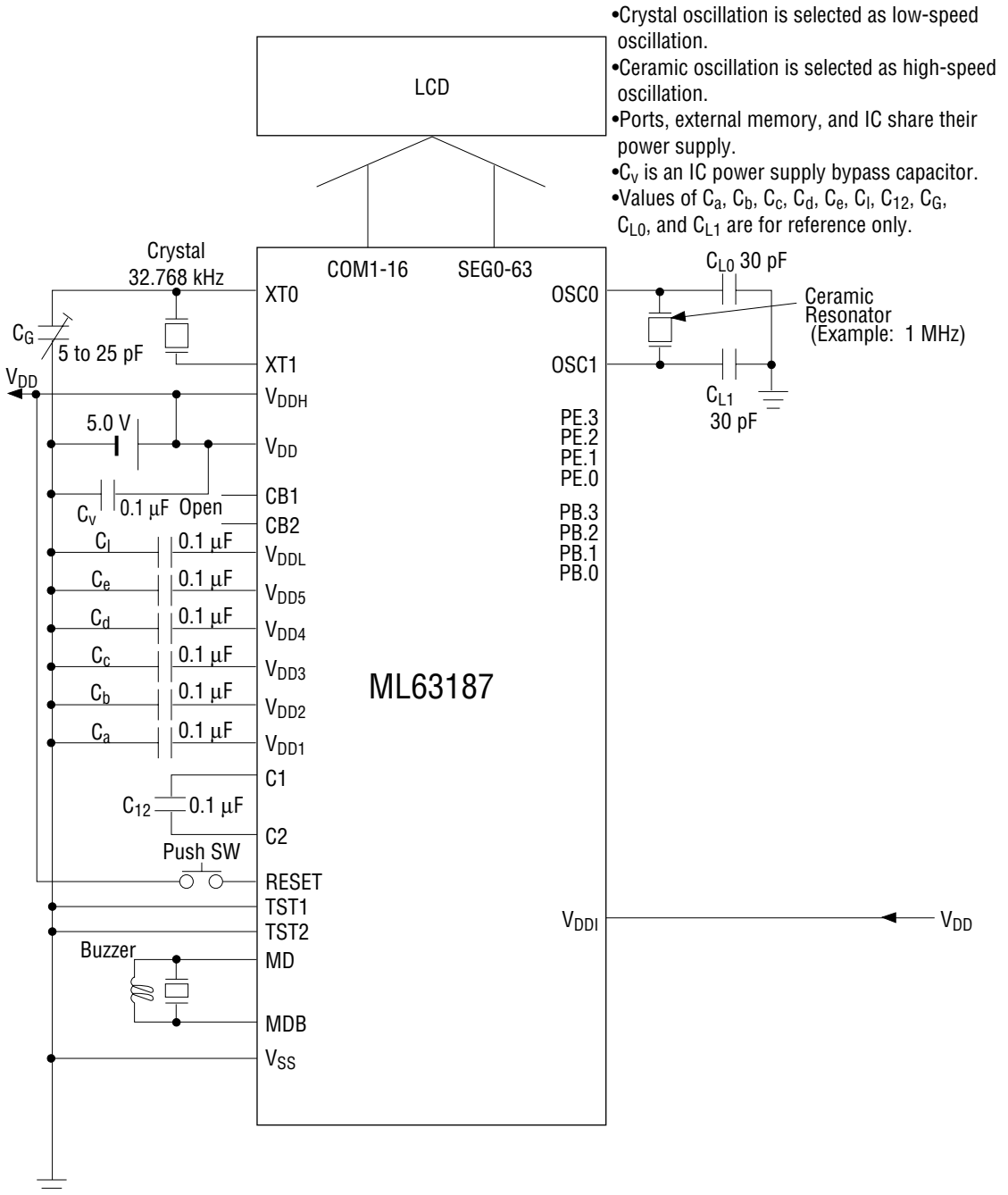

- Crystal oscillation is selected as low-speed oscillation.
- Ceramic oscillation is selected as high-speed oscillation.
- Ports, external memory, and IC share their power supply.
- C_v is an IC power supply bypass capacitor.
- Values of C_a, C_b, C_c, C_d, C_e, C_l, C₁₂, C_G, C_{L0}, and C_{L1} are for reference only.

Note: V_{DDI} is the power supply pin for the input-output ports. Be sure to connect the V_{DDI} pin either to the positive power supply pin (V_{DD}) of this device or to the positive power supply pin of the external memory.

Application Circuit Example with No Power Supply Backup

APPLICATION CIRCUITS (ML63189B)

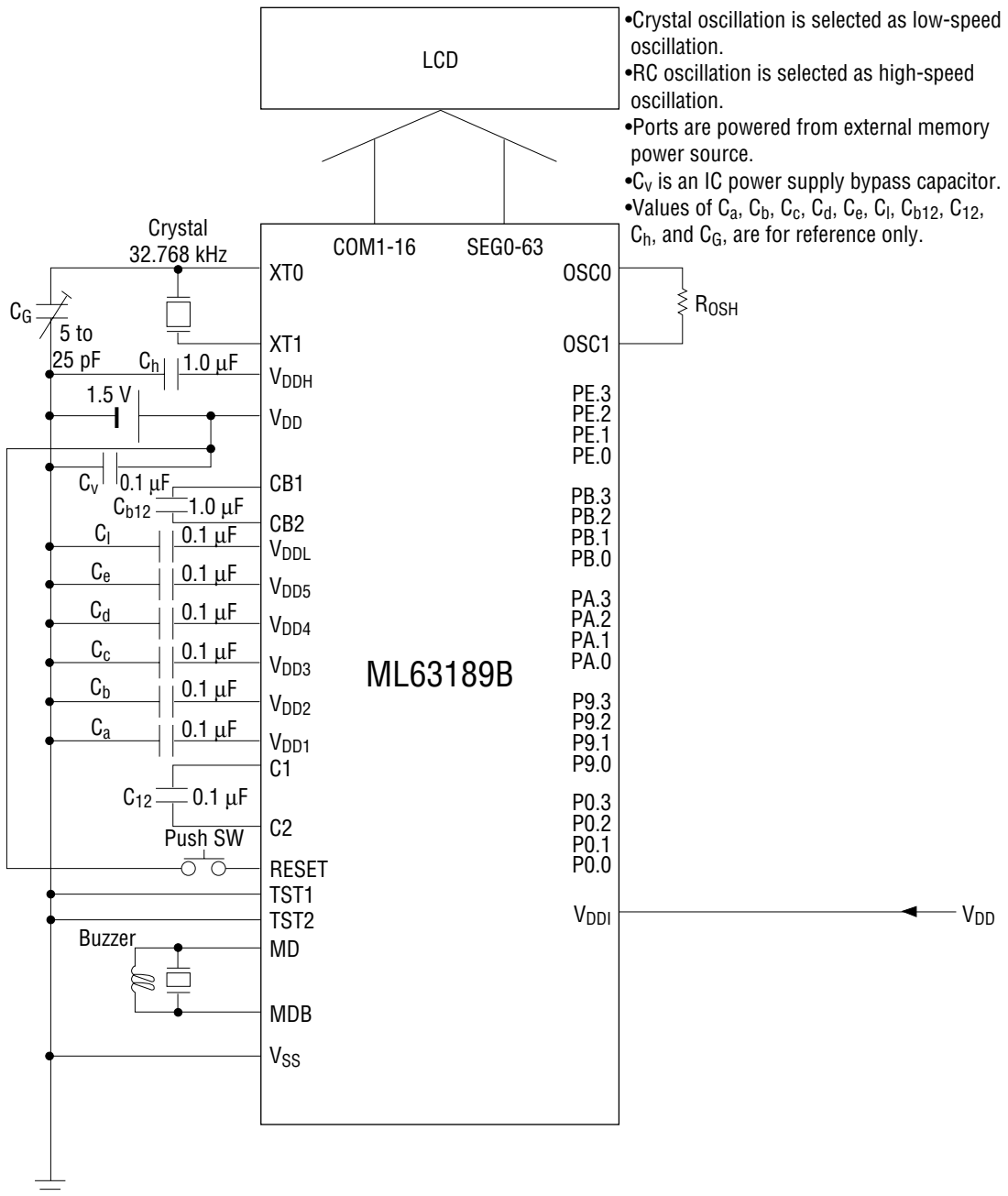

- Crystal oscillation is selected as low-speed oscillation.
- RC oscillation is selected as high-speed oscillation.
- Ports are powered from external memory power source.
- C_v is an IC power supply bypass capacitor.
- Values of C_a, C_b, C_c, C_d, C_e, C_i, C_{b12}, C₁₂, C_h, and C_G, are for reference only.

Note: V_{DDI} is the power supply pin for the input and input-output ports. Be sure to connect the V_{DDI} pin either to the positive power supply pin (V_{DD}) of this device or to the positive power supply pin of the external memory.

Application Circuit Example with Power Supply Backup

APPLICATION CIRCUITS (ML63189B)

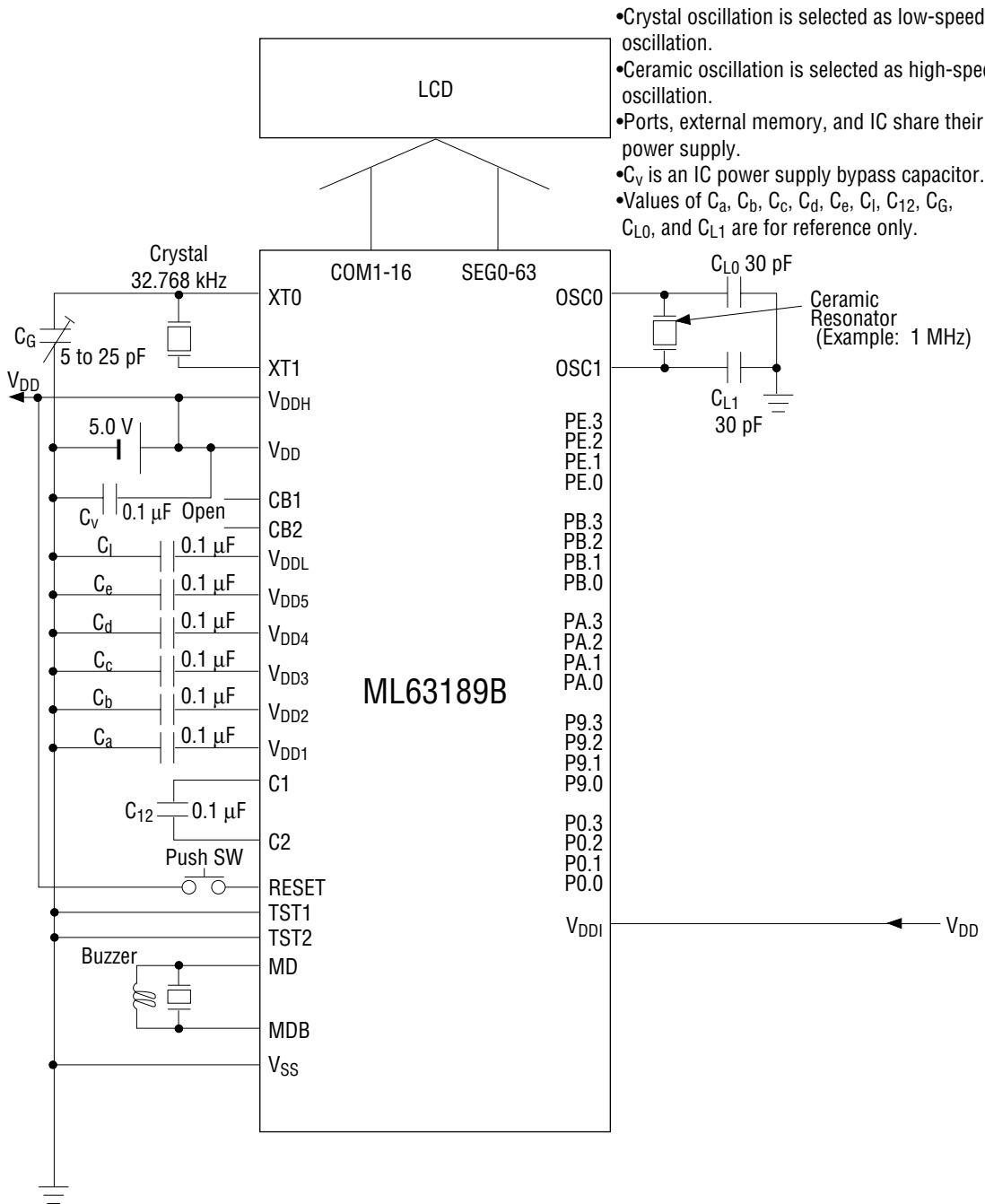

- Crystal oscillation is selected as low-speed oscillation.
- Ceramic oscillation is selected as high-speed oscillation.
- Ports, external memory, and IC share their power supply.
- C_v is an IC power supply bypass capacitor.
- Values of C_a, C_b, C_c, C_d, C_e, C_l, C₁₂, C_G, C_{L0}, and C_{L1} are for reference only.

Note: V_{DDI} is the power supply pin for the input and input-output ports. Be sure to connect the V_{DDI} pin either to the positive power supply pin (V_{DD}) of this device or to the positive power supply pin of the external memory.

Application Circuit Example with No Power Supply Backup

PACKAGE DIMENSIONS

(Unit : mm)

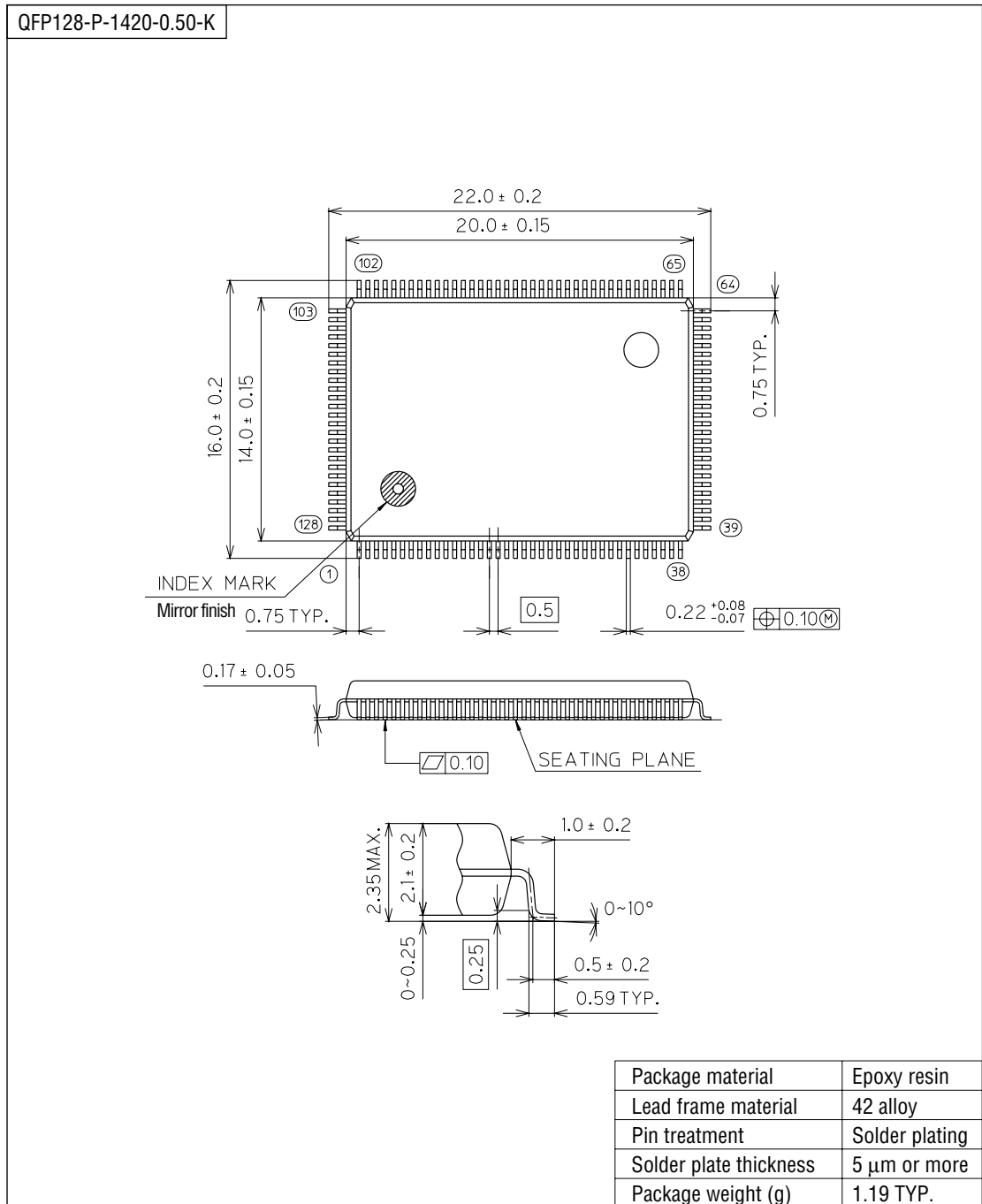

Notes for Mounting the Surface Mount Type Package

The SOP, QFP, TSOP, TQFP, LQFP, SOJ, QFJ (PLCC), SHP, and BGA are surface mount type packages, which are very susceptible to heat in reflow mounting and humidity absorbed in storage. Therefore, before you perform reflow mounting, contact Oki's responsible sales person on the product name, package name, pin number, package code and desired mounting conditions (reflow method, temperature and times).

NOTICE

1. The information contained herein can change without notice owing to product and/or technical improvements. Before using the product, please make sure that the information being referred to is up-to-date.
2. The outline of action and examples for application circuits described herein have been chosen as an explanation for the standard action and performance of the product. When planning to use the product, please ensure that the external conditions are reflected in the actual circuit, assembly, and program designs.
3. When designing your product, please use our product below the specified maximum ratings and within the specified operating ranges including, but not limited to, operating voltage, power dissipation, and operating temperature.
4. Oki assumes no responsibility or liability whatsoever for any failure or unusual or unexpected operation resulting from misuse, neglect, improper installation, repair, alteration or accident, improper handling, or unusual physical or electrical stress including, but not limited to, exposure to parameters beyond the specified maximum ratings or operation outside the specified operating range.
5. Neither indemnity against nor license of a third party's industrial and intellectual property right, etc. is granted by us in connection with the use of the product and/or the information and drawings contained herein. No responsibility is assumed by us for any infringement of a third party's right which may result from the use thereof.
6. The products listed in this document are intended for use in general electronics equipment for commercial applications (e.g., office automation, communication equipment, measurement equipment, consumer electronics, etc.). These products are not authorized for use in any system or application that requires special or enhanced quality and reliability characteristics nor in any system or application where the failure of such system or application may result in the loss or damage of property, or death or injury to humans. Such applications include, but are not limited to, traffic and automotive equipment, safety devices, aerospace equipment, nuclear power control, medical equipment, and life-support systems.
7. Certain products in this document may need government approval before they can be exported to particular countries. The purchaser assumes the responsibility of determining the legality of export of these products and will take appropriate and necessary steps at their own expense for these.
8. No part of the contents contained herein may be reprinted or reproduced without our prior permission.
9. MS-DOS is a registered trademark of Microsoft Corporation.

Copyright 1999 Oki Electric Industry Co., Ltd.