

Features

- 144bit EEPROM code
- Very small size 125kHz Read/Write Transponder
- Very Big reading range, and large write range.
- EEPROM programmable Configuration word for different encoding and data rate options
- 80pF integrated tuning capacitance
- 100,000 write cycle, 10 year EEPROM retention
- Single command programming with integrity check.
- Dimensioned for ISO-chipcard, without need for tag module.
- Conceived for use and without Goldbumps

Applications

Animal ID (ISO 11784/-85 compliant), Access Control, Juke box logistics control, Material Logistics, Production Flow Control.

Ordering Information

Part No.	Temperature Ranges	Delivery form
MLX90110	25 °C Consumer -40 to 85 °C Automotive	Sawed wafer on frame Bare die in blistertape SOIC-8 150mils

Production parts available Q2 2001

Functional Diagram

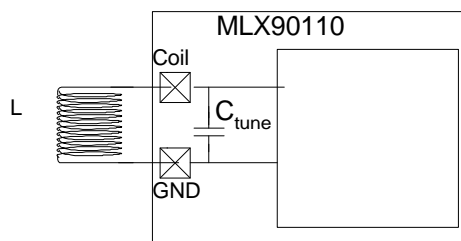

Description

The MLX90110 is a 128bit Read Write and OTP transponder operating at 125kHz. It has been designed as a low cost read write solution for applications which don't require high flexibility in terms of write range, like in production environments.

Clock and power supply are taken from the electromagnetic field. A resistor is switched in parallel to the resonant circuit formed by the integrated tuning capacitor (80pF) and the external coil to amplitude modulate the electromagnetic field. No external components are needed except for the antenna coil.

The EEPROM is configured as 9 words of 16 bits. Words 1 to 8 form the ID and are continuously read out during normal operation.

The transponder can be configured for Manchester or Biphase encoding, at 2 or 4 kBaud by programming the corresponding bits in the 9th EEPROM word.

By setting 2 other bits in the 9th word, the transponder memory can be partially or completely locked. In the latter case it becomes a Read Only transponder. In the first mode words 5, 6, 7, 8 and 9 can be rewritten with password access.

MLX90110 Electrical Specifications

Operating Parameters are based on test set up (see Schematic below).

$T_{oper} = -40^{\circ}\text{C}$ to 85°C , Operating frequency = 120kHz (unless otherwise specified)

Parameter	Symbol	Test Conditions	Min	Typ	Max	Units
Regulated supply voltage	VDD	(3)	3.0		4.0	V
Power On Level	VPOR	Continuous normal reading of the ID	1.55	1.8	2.2	V
Sensitivity level	Vacsens	Continuous normal reading of the ID	200	170		mV (4)
Transponder Modulation Depth		Weak power: Vacmin = 200mVpp	0.3		4	V
		Medium power: Vac = 5Vpp	2.8		7.5	V
		High power: Vac = 20Vpp	5		10	V
High Programmation voltage	Vacprh		5			V (4)
Low Programmation voltage	Vacprl				2.5	V (4)
EEPROM writing supply current	I _{ee}			10		μA
EEPROM data retention	T _{ret}	Critical reading ID	10			year
EEPROM write cycles	N _{cycle}	Critical reading ID	100k			cycles
Coil-GND tune capacitor		$T_{oper}=25^{\circ}\text{C}$	77	80	83	pF
DC input current clamping	I _{clampLow}	V _{dut} DC = +/- 2V		40	1000	nA
	I _{clampHigh}	V _{dut} DC = +/- 10V	1	3.5	10	mA

Notes:

Note (1): All specification values are characterized and tested 100%, or guaranteed by design.

Note (2): All specifications are valid for Manchester and Biphase encoding, and for 2kbaud and 4kbaud data rate options.

Note (3): Maximum supply voltage is generated by forcing 10mA between coil and ground pin.

Note (4): For the test setup, AC generator voltages are equivalent to following voltages on the coil: see graph (to be added).

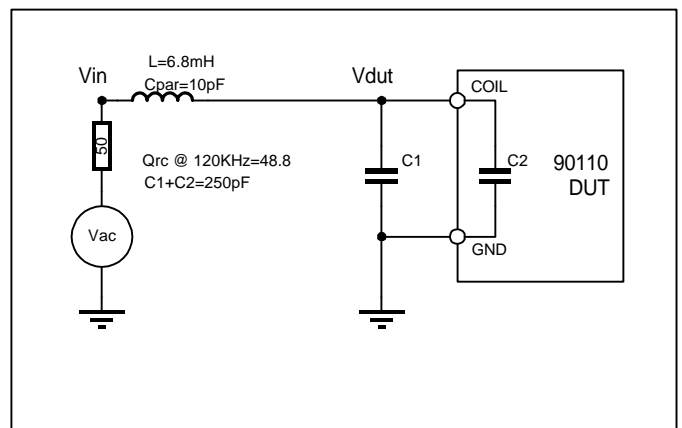

General Description

The MLX90110 is a 128bit Read Write transponder IC for fixed distance writing. The integrated tune capacitance and the external coil form a resonant LC antenna that absorbs part of the electromagnetic energy radiated by the transceiver LC antenna. Physically, a magnetic coupling occurs between the transceiver, also referred to as "reader", and transponder antennas.

To amplitude modulate (AM) the RF carrier, the transponder damps the electromagnetic field by switching a resistor in parallel with its coil. This way the transponder repetitively transmits its 128bit-identification code (ID) to the transceiver, which recovers the envelope of the damped field, and decodes the ID.

The transceiver can send commands and data to the transponder by modulating the amplitude of the carrier.

POR level

When the transponder is placed in an external radio frequency (RF) field of appropriate frequency and amplitude, the internal power supply (VDD) can build up as charge on the integrated buffer capacitance. The modulation resistor is switched on and off as soon as VDD has reached the Power On Reset (POR) level. When the modulation resistor is switched on, the LC circuit is no longer tuned, therefore no energy is taken from the field, and VDD drops due to internal consumption. Hence, by switching the modulation resistor on and off, it is possible to oscillate around the POR level. This phenomenon is referred to as hiccuping. The modulation resistor is switched off when the transponder drops below the POR level.

Sensitivity level

The minimum electromagnetic force (e.m.f.) needed to avoid hiccuping is defined by Vacsens. At this level the power supply will not drop below the POR level while the modulation resistance is switched on during modulation.

Clock recovery

The transponder takes its clock from the carrier frequency. Depending on the speed option, the carrier frequency is divided by 32(4kbaud), 64(2kbaud) to generate the bit rate.

Demodulator

If the external RF field is AM modulated according to the asynchronous control pattern (ACP, see below), the transponder stops transmitting the 128bit ID and enters the Program Mode. Each bit period a sample is taken. The transponder synchronizes on the first bit (startbit) of each new word that is transmitted. The high and low programming levels (Vacpr) have to be applied in order for the transponder to detect the ACP and recover the data, which are sent to tag during a programming cycle.

For this reason the transponder can only be programmed at a certain distance which is defined by the system parameters, taken Vacpr into account.

RF limiter, or clamping

The build up of voltage on the resonant LC circuit is limited to avoid damaging the internal circuit. This causes the transponder Q to drop at higher fields.

Modulator

The modulator consists of a modulation resistor that is switched in parallel with the resonant LC circuit (antenna). Because in weak RF fields the rising edge is much slower than the falling edge of the envelope, a symmetrically driven modulator would give an asymmetrical envelope. This is anticipated by delaying each falling edge by a fixed number of RF clock pulses. The modulator is hence driven asymmetrical. Each ON state is reduced by 8 (4) clocks in 2 (4) kBaud mode, and each OFF state is prolonged by the same amount.

Speed	Total clocks per Bit	Clocks 'ON' state	Clocks 'OFF' state
2kbaud	64	Long ON = 64 - 8 Short ON = 32 - 8	Long ON = 64 + 8 Short ON = 32 + 8
4kbaud	32	Long ON = 32 - 4 Short ON = 16 - 4	Long ON = 32 + 4 Short ON = 16 + 4

EEPROM Memory organization

The EEPROM memory is arranged as 9 words of 16 bits each (see memory map above). Each one of these words is individually programmable.

IDENTIFICATION WORDS (Addresses #0 to #7)

The first 8 words hold the 128bits identification code (ID).

CONFIGURATION WORD (Address #8)

The 9th word contains:

- **SPEED (bit 0:LSB)**
Speed bit defines the internal clock extraction: set to 1 for divided by 32, set to 0 for divided by 64.
- **CODE (bit 1)**
Code bit defines if the ID will be encoded in Manchester (set to 1) or Biphase (set to 0) amplitude modulation scheme.
- **WP (bit 2)**
The Write Protect bit locks the complete EEPROM, including the configuration bits (SPEED, CODE). See Read Only Operating Mode
- **RW (bit 3)**
The Read Write bit locks only the first 4 words, and write access is password protected. See Protect Write Operating Mode. If WP=1, the value is not relevant (don't care).
- All remaining bits are not used (don't care).

SPEED	CLOCK	BAUD RATE
0	Freq/64	2kbaud
1	Freq/32	4kbaud

CODE	ENCODING
0	Biphase
1	Manchester

OPERATING MODES

After Power up reset (POR) the device starts to amplitude modulate (AM) the electro magnetic field. The modulation sequence is based on the data stored in the EEPROM, using normal EEPROM read out levels (compared with critical read mode below).

The behavior of the transponder is fixed at POR, depending on the options set in the configuration word. To change this behavior the configuration word has to be rewritten, and the tag has to be removed from the field to allow a new POR sequence.

Depending on the configuration bits WP and RW 3 basic operating modes are possible:

OPERATING MODE	WP	RW
Unprotected Write	0	0
Protected Write	0	1
Read Only	1	x

Write Modes (WP=0)

When the Write Protect bit has not yet been set (WP=0), the MLX90110 will stop modulating and enter the program mode when the external field is Amplitude Modulated with an Asynchronous Control Pattern (ACP, specified below).

PROGRAM MODE:

When the MLX90110 has detected an ACP the address counter is reset (=0), and the transponder waits for a start bit (SB) during a Watchdog Delay period (TWD) to synchronize with the rest of the data stream.

The data are not encoded: a field strength higher than Vacprh is interpreted as a 1, and below Vacprl as a 0.

Each programming cycle consists of a SB and the 16bit data, which are sent by the reader, and a fixed time to allow the transponder to erase and write the EEPROM word. During this time, the field must be at Vacprh to guarantee a good quality of programming. The next address is calculated by incrementing the address counter, and the next programming cycle can follow.

Until the ninth word has been received the transponder resets the watchdog after each programming cycle, and waits for the next SB to resynchronize. After receiving the ninth word, the transponder leaves the program mode.

It is possible to leave the program mode before, when a time out occurs whilst waiting for the SB.

When the transponder leaves the program mode it enters the critical read mode when the address counter is set to 4 or more. When a timeout occurs before finishing to write the 4th word the transponder returns to the corresponding write mode, and waits for a new ACP.

CRITICAL READ MODE:

In the 'critical' read mode, all 9 words are alternately read at the 2 extremes of the EEPROM reading window.

When both readings are identical, the data retention is guaranteed as specified (Tret, Ncyc). If the two critical readings show a difference, the device has been programmed marginally. It should then be reprogrammed.

(TIP: Critical read failures can only occur when the magnetic field strength is not kept constant at Vacprh during the erase and write period after the data have been sent to the transponder.)

The critical read latch is set after setting the address counter to 4 (this is the address of word 5). The latch can only be reset by removing the transponder from the field.

The MLX90110 has 2 different Write modes, for which the same program and critical read modes are applicable.

UNPROTECTED WRITE mode

(WP=0,RW=0)

The unprotected Write mode, is a Write mode in which all 9 words can be programmed.

In normal (after POR) read mode all 9 words are transmitted.

When the transponder detects the ACP it enters program mode, without password protection.

The first SB will start the programming cycle of the first word, etc.

PROTECTED WRITE mode

(WP=0, RW=1)

The Protected Write mode, is a Write mode in which only words 5, 6, 7 and 8 of the ID and the configuration word 9 can be rewritten.

After POR the 8 words from the ID are transmitted. Therefore it can be used together with Transponders which have been set to Read Only mode.

When the transponder detects the ACP it enters program mode, with password protection.

The transponder will use its first 4 words as a password. This avoids any hazardous erase, by an occasional fluctuation of the external field, which could be interpreted as an ACP followed

by a SB, for instance when the transponder is removed from the field.

A password cycle is a programming cycle in which the 16bits sent by the reader should match the data stored in the corresponding word of the transponder. The word is not erased and rewritten.

Remark that it is possible to program only one or a few words by taking advantage of the timeout option in the programming cycle.

READ ONLY Mode (WP=1, RW=x)

If the Write Protect bit is set (WP=1), the device will not react to any modulation on the reader antenna. It behaves like a regular Read Only (RO) transponder, by continuously transmitting its ID: 128bit from the first 8 words.

3 Timing specification

3.1 Asynchronous Control Pattern

The ACP is a pattern send by the reader to the transponder without any synchronization. It signals the transponder to stop transmitting and listen for a programming sequence.

The control pattern is based on the detection of 4 transitions between high field strength (FHIGH or Vacprh) and low field strength (FLOW or Vacprl). After the control pattern has been successfully detected, the transponder stops modulating.

Before starting the ACP, the field must be stable at FHIGH for at least 2 bit periods (Tas).

Right after the last ACP transition, there is an additional delay equal to Tas before the transponder resets the watchdog counter (TWD). During this delay the Field can be put back to high to optimise operating distance.

The transponder samples the field strength once per bit. An edge will be detected correctly if the tag has sampled at least 2 consecutive values on one level, and then at least 2 values at the other level. Therefore, Tas should be longer than 2 bit, to guarantee that the transition will be correctly detected. The four transitions (TACP) should be completed in timeout of 16 periods (TACP).

If the startbit is not detected within 16 periods (TWD) after TACP a time out will occur. See operating modes to see correct flow at time out.

3.2 Other timings

The startbit is followed by a 16bit word, which will be programmed at the address defined by the address counter. This counter is reset when the ACP is received. It increments after each new word.

The other timings can be calculated based on the formulas below.

Data send to transponder										
TACP	TWD	SB	Treceive	Terase	Twrite	TWD	SB	Treceive	Terase	Twrite
≤16	≤16	1	16	16	16	≤16	1	16	16	16
Transponder mode/operations										
Normal Read	Stop modulation	Start bit detection	RECEIVE DATA	ERASE WORD	WRITE WORD	Watchdog time out	New startbit	RECEIVE DATA	WRITE WORD	ERASE WORD

MLX90110 Timing Specifications (carrier: Freq=125kHz, Tclk=8μs)			
Speed	Bit period	TWD / Tsend	Terase/ Twrite
	Tclk	Tclk*1024	Tclk*1024
Freq/64 (2kbaud)	0.512ms	8.912ms	8.912ms
Freq/32 (4kbaud)	0.256ms	4.096ms	4.096ms

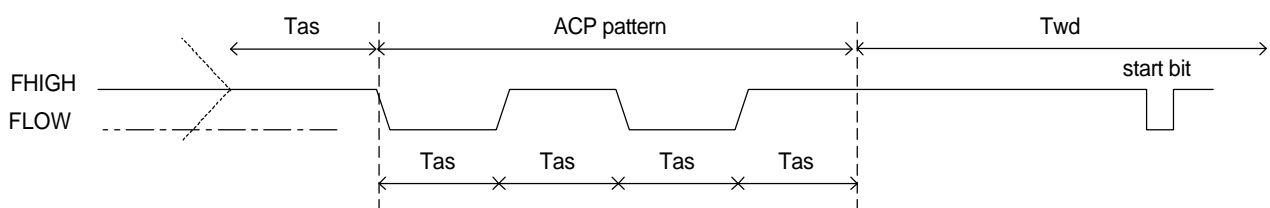

Data encoding schemes

Manchester

For a “1” bit, there is a transition from 0 to 1 in the middle of the bit period. Reciprocal, for a “0” logic bit there is a transition from 1 to 0 in the middle of the bit period.

Biphase

At the beginning of each bit, a transition will occur. A logic bit “1” will keep its state for the whole bit duration and a logic bit “0” will show a transition in the middle of the bit duration.

Manchester Code

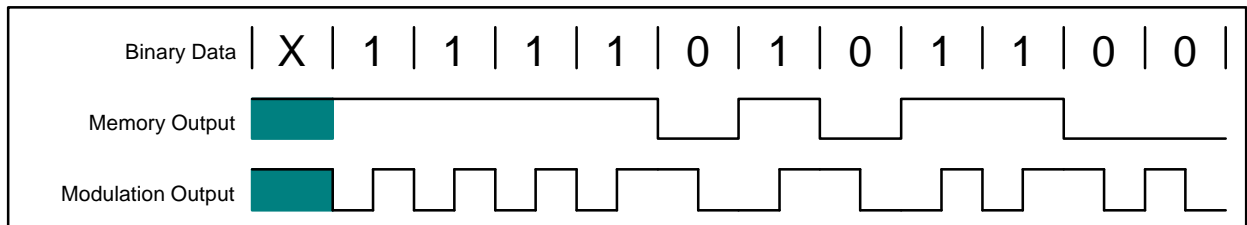

Biphase Code

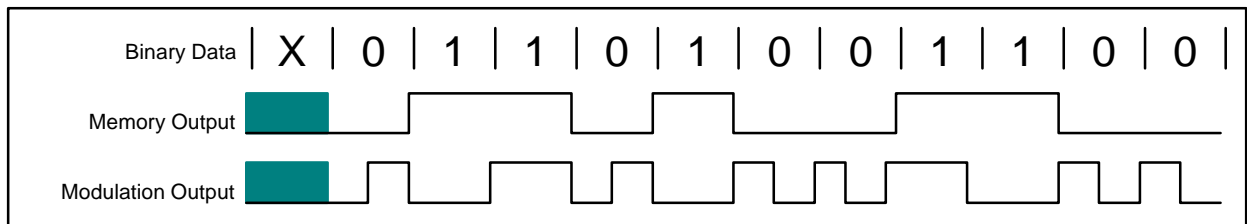

Flow Chart.

Upon entering the RF field, the transponder "sees" increasing amplitude of the voltage between COIL and GND pins. It passes through a POR sequence. Depending on the configuration bits it will enter the appropriate mode.

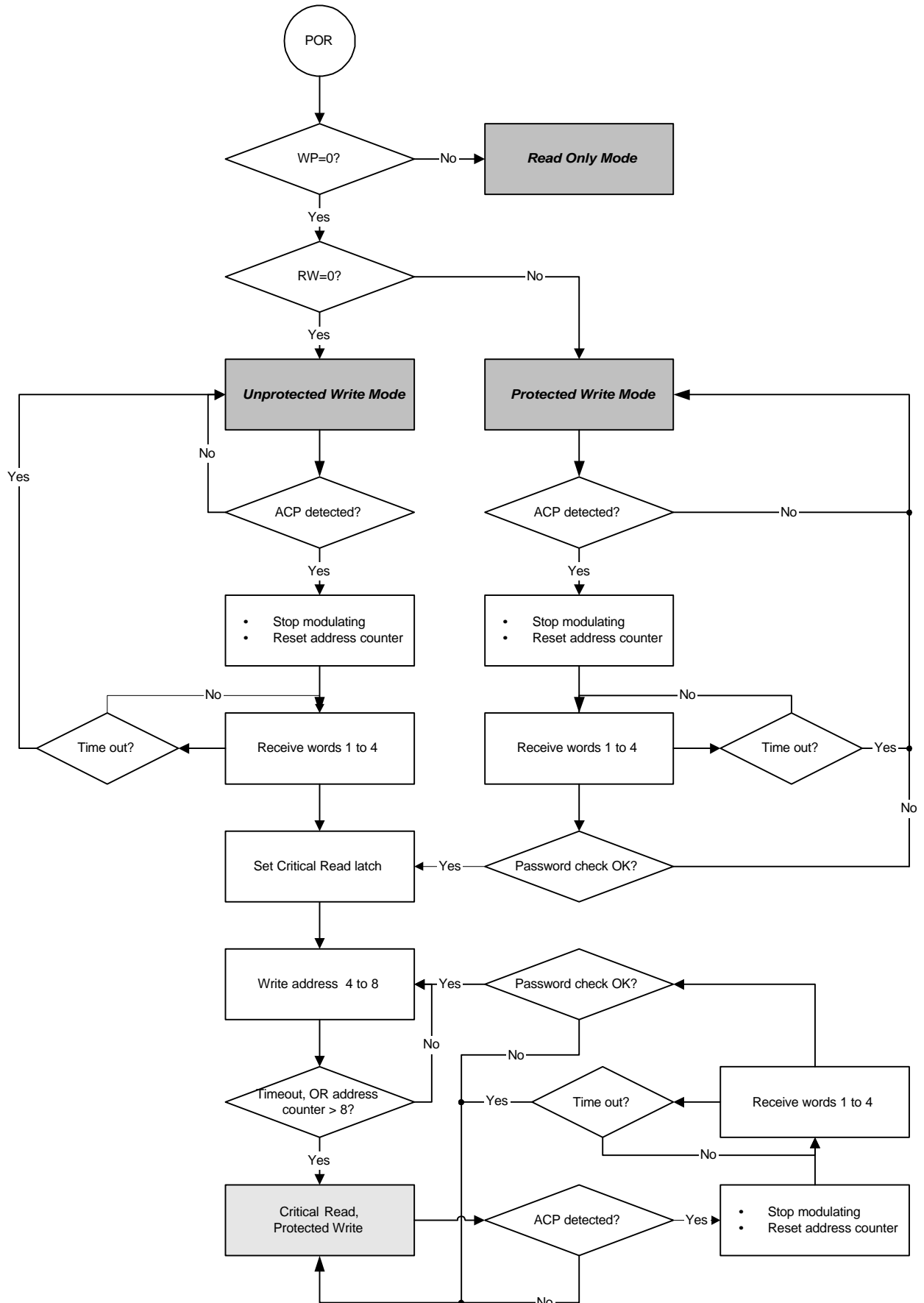

Unique Features

- Flexible configuration.
- Simple fast programming.
- State of the art reading distance.
- Ideal for flexible stock management of RO devices, Animal ID, ...
- Designed to be used in ISO Smart cards, without need for costly tag modules.

Cross Reference

This product can replace any AM modulating OTP transponder in the 120kHz range. It extends the flexibility of a RO transponder, and offers the cheapest solution for a Read Write transponder, which needs to be programmed only once.

Absolute Maximum Ratings

Maximum Power Supply (VDDmax)	-0.7 to 7V
Maximum current forced between coil and ground pin (Icoilmax)	+ / - 30mA
Operating Frequency (Freq)	60 to 150kHz
Normal Operating Temperature (Toper)	-40 to 85°C
Maximum Storage Temperature in SO8 (Tstore)	-55 to 125°C
Electrostatic discharge (HBM) on coil pin (Vesdcoil)	500V
Electrostatic discharge (HBM) on other pins (Vesd)	1500V
Maximum storage light flux (EEPROM erase)	
Maximum operating light flux	

ESD Precautions

Electronic semiconductor products are sensitive to Electro Static Discharge (ESD). Always observe Electro Static Discharge control procedures whenever handling semiconductor products.

Disclaimer

Melexis reserves the right to periodically make modifications to product specifications. The information included herein is believed to be accurate and reliable. However, Melexis assumes no responsibility for its use, nor for any infringements of patents or other rights of third parties which may result from its use.

Pinout

Pin	Name	Function
1	COIL	Coil connection 1
4,5,8	VSS	Coil connection 2 / ground connection
Other pins are not connected..		

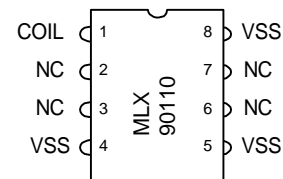

Chip dimensions

Total area = 2.45mm².

