

System Reset (with battery back-up) Monolithic IC MM1027, 1081

Outline

These ICs were developed for STATIC-RAM (S-RAM) battery back-up, and have built-in switching circuit for main power supply and battery, back-up timing circuit and battery checker.

Power ON/OFF and momentary power interruptions can damage S-RAM data on equipment that contains an S-RAM. These ICs switch the S-RAM to back-up mode (CS signal makes S-RAM CE pin low and \overline{CE} pin high) when power supply voltage goes below a set voltage (detection voltage 4.2V typ., variable), preventing damage to data. Further, when power supply voltage drops, these ICs switch from main power supply to battery back-up (switching voltage 3.3V typ.). Then, when power supply voltage rises, they first switch the S-RAM from battery back-up state to main power supply (switching voltage 3.3V typ.), and from back-up mode to normal mode (CS signal makes S-RAM CE pin high and \overline{CE} pin low). These signal processes provide reliable protection against data damage. The CS signal also can absorb power supply chattering and roughness through the external capacitor.

There is a built-in battery checker to monitor the back-up battery voltage, and this circuit is turned ON/OFF by the control pin.

Features

1. Battery back-up

- | | | |
|---|---------------|------------------|
| 1. Low IC current consumption (loss current) | | 0.3 μ A typ. |
| 2. Drop voltage inside IC (input/output voltage difference) | $I_o=10\mu A$ | 0.2V typ. |
| 3. Reverse current (reverse leak current) | | 0.1 μ A max. |

2. Normal operation

MM1027

- | | | |
|--|---------------------------|------------|
| Drop voltage inside IC (input/output voltage difference) | $I_o=70mA$ | 0.2V typ. |
| Output voltage | $V_{CC}=5V$
$I_o=10mA$ | 4.8V typ. |
| Current consumption | D.CONT OPEN | 3.0mA max. |
| External transistor drive current | | 25mA typ. |

MM1081

- | | | |
|---|----------------------------|------------------|
| Drop voltage inside IC (input/output voltage difference) | $I_o=120mA$ | 0.25V typ. |
| Output voltage | $V_{CC}=5V$
$I_o=120mA$ | 4.75V typ. |
| Current consumption | | 350 μ A max. |
| External transistor drive current (for output current increase) | | 25mA typ. |
| TC source current | | 3.0 μ A typ. |

3. Battery-Vcc switching voltage

3.3V typ.

4. Detection voltage (CS, \overline{CS}) variable

4.2V typ.

5. Battery checker 1

X type	2.70V typ.
N type	2.50V typ.

6. Battery checker 2

X type	2.55V typ.
N type	2.35V typ.

Package

TSOP-20A (MM1027XV, MM1027NV, MM1081XV)

SOP-16A (MM1027XF, MM1027NF)

DIP-16A (MM1027XD)

Applications

1. IC memory cards (RAM cards)
2. PCs, word processors
3. Fax machines, photocopiers, other office equipment
4. Other equipment with S-RAMs (equipment requiring back-up)

Pin Assignment

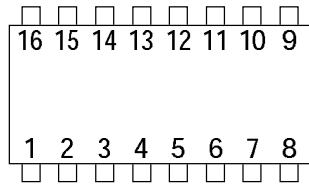

SOP-16A/DIP-16A

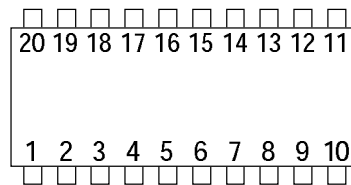

TSOP-20A

Pin no.	Function		
	TSOP-20A	SOP-16A	DIP-16A
1	GND	GND	GND
2	ADJ.	NC	NC
3	NC	ADJ.	ADJ.
4	TC	TC	Tc
5	NC	CS	CS
6	CS	NC	NC
7	NC	$\overline{\text{CS}}$	$\overline{\text{CS}}$
8	$\overline{\text{CS}}$	DET.CONT	DET.CONT
9	NC	Bat.DET1	Bat.DET1
10	DET.CONT	NC	NC
11	Bat.DET1	Bat.DET2	Bat.DET2
12	NC	Battery	Battery
13	Bat.DET2	V _{OUT}	V _{OUT}
14	NC	External drive	External drive
15	Battery	NC	NC
16	NC	V _{CC}	V _{CC}
17	V _{OUT}		
18	NC		
19	External drive		
20	V _{CC}		

Block Diagram

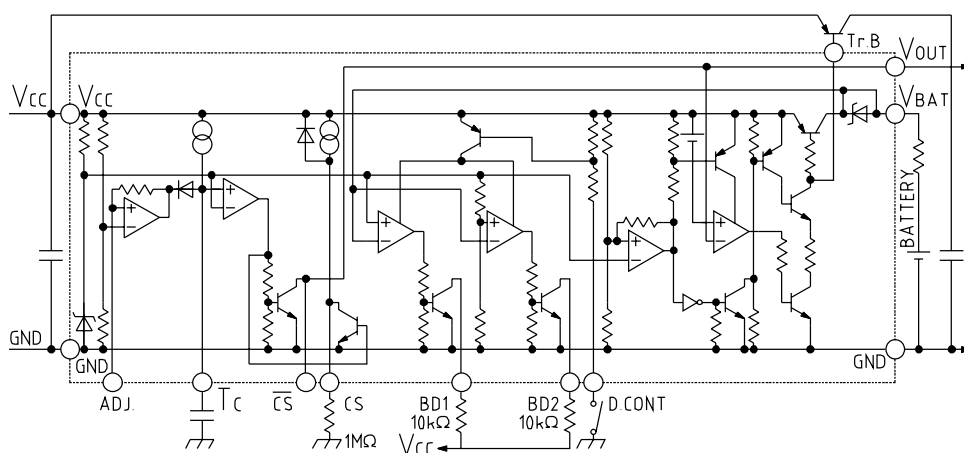

Absolute Maximum Ratings (Ta=25°C)

Item	Symbol	Rating	Units
Storage temperature	T _{STG}	-40~+125	°C
Operating temperature	T _{OPR}	-20~+70	°C
Power supply voltage	V _{CC max.}	7	V
Operating voltage	V _{CCOP}	7	V
Allowable loss	P _d	300	mW
Output current	MM1027	I _{o1}	90 mA
	MM1081	I _{o1}	120 mA
Output current	I _{o2}	200	μA

Note : I_{o1} expresses V_{CC} output current value, and I_{o2} expresses V_{BATT} output current value.

Electrical Characteristics (Except where noted otherwise, Ta=25°C, V_{CC}=5V, V_{BAT}=3V)

Item		Symbol	Measurement conditions	Min.	Typ.	Max.	Units	
All circuits	Consumption current 1	MM1027	V _{CC} =5V, V _{BAT} =3V, I _O =0mA D.CONT pin : OPEN	0.9	1.7	3.0	mA	
		MM1081	V _{CC} =5V, V _{BAT} =3V, I _O =0mA	150	210	350	μA	
	Consumption current 2	MM1027	V _{CC} =5V, V _{BAT} =3V, I _O =0mA D.CONT pin : GND	1.2	2.2	3.5	mA	
CS- $\overline{\text{CS}}$ circuit unit	CS, $\overline{\text{CS}}$ detection voltage 1	V _{s1}	V _{CC} =H→L, V _{BAT} =3V, ADJ pin : OPEN	4.05	4.20	4.35	V	
	CS, $\overline{\text{CS}}$ hysteresis voltage 1	ΔV_{s1}	V _{CC} =L→H	0.05	0.10	0.20	V	
	Detection voltage temperature characteristic	MM1027	V _s /ΔT				±0.08	%°C
		MM1081					±0.06	
	CS, $\overline{\text{CS}}$ detection voltage 2	V _{s2}	V _{CC} =H→L, V _{BAT} =3V ADJ pin : 12kΩ PULL UP (to V _{CC})	3.25	3.50	3.75	V	
	CS, CS hysteresis voltage 2	ΔV_{s2}	V _{CC} =L→H	0.05	0.10	0.20	V	
	CS output voltage L	V _{CSL}	V _{CC} =3V, I _{CS} =3μA		0.05	0.10	V	
	CS output voltage H	V _{CSH}	V _{CC} =5V, I _{CS} =-3μA	4.85	4.95		V	
CS source current	I _{CSH}	V _{CC} =5V, V _{CS} =4.6V current measured	8	15		μA		

Electrical Characteristics (Except where noted otherwise, Ta=25°C, VCC=5V, VBAT=3V)

Item		Symbol	Measurement conditions	Min.	Typ.	Max.	Units	
CS-CS circuit unit	CS sync current	ICSL	VCC=3.5, VCS=0.4V Current measured	0.5	2.0	-	mA	
	CS output voltage L	VCSL	VCC=5V, ICS=3μA	-	0.10	0.25	V	
	CS output voltage H	VCSH	VCC=4V, VOUT-VCSH, ICS=-3μA	-	0.14	0.40	V	
	CS sync current	ICSL	VCC=5V, VCS=0.4V Current measured	0.3	1.0	-	mA	
	Operation limit voltage L	VOPL	Minimum power supply voltage at which CS pin can hold low level VCS ≤ 0.4V	-	2.0	2.4	V	
	ON delay time 1	tPLH1	VCC=L → H, TC : OPEN, C1=47pF	-	30	-	μS	
	OFF delay time 1	tPHL1	VCC=H → L, TC : OPEN, C1=47pF	-	2.0	5	μS	
	ON delay time 2	tPLH2	VCC=L → H, TC : 1nF, C1=47pF	-	0.8	-	mS	
	OFF delay time 2	tPHL2	VCC=H → L, TC : 1nF, C1=47pF	-	2.0	10	μS	
BD circuit unit	BATT detection voltage 1	MM1027X MM1081N	VBD1	VCC=5V, R1=10kΩ PULL UP VBAT=H → L (to VCC)	2.60	2.70	2.80	V
	BATT hysteresis voltage 1		ΔVBD1	VCC=5V, R1=10kΩ PULL UP VBAT=L → H (to VCC)	0.05	0.10	0.20	V
	BATT detection voltage 2	MM1027X MM1081N	VBD2	VCC=5V, R2=10kΩ PULL UP VBAT=H → L (to VCC)	2.45	2.55	2.65	V
	BATT hysteresis voltage 2		ΔVBD2	VCC=5V, R2=10kΩ PULL UP VBAT=L → H (to VCC)	0.05	0.10	0.20	V
	BD output voltage L		VBDL	VCC=5V, VBAT=0V	-	0.2	0.4	V
	BD output sink current		IBDSNK	VCC=5V, VBAT=0V, VBD=4V	1.0	3.0	-	mA
	Leakage current		IBDH	VCC=5V, VBAT=3V, VBD=5V	-	-	0.2	μA
Backup circuit unit	I/O voltage difference 1	MM1027 MM1081	V _{SAT1}	VCC=5V, IO=70mA	-	0.2	0.3	V
				VCC=5V, IO=120mA	-	0.25	0.4	
	I/O voltage difference 2		V _{SAT2}	VBAT=3V, IO=10μA	-	0.2	0.3	V
	I/O voltage difference 3		V _{SAT3}	VBAT=3V, IO=100μA	-	0.3	0.4	V
	External transistor driving current		IBUD	VCC=5V, V (T _B) =4.5V	16	25	-	mA
	Power supply switching voltage		V _{BB}	VCC=H → L, VBAT=3V	3.15	3.30	3.45	V
	Hysteresis voltage		ΔV _{BB}	VCC=L → H, VBAT=3V	0.05	0.10	0.20	V
	Switching voltage temperature characteristic	MM1027 MM1081	V _{BB} /ΔT		-	-	±0.08 ±0.06	%/°C
	Loss current		I _{LOS}	VCC=0V, VBAT=3V, IO=0μA D.CONT pin : GND	-	-	0.3	μA
	Reverse current		I _{OREV}	VCC=0V, VBAT=3V, IO=0μA D.CONT pin : OPEN	-	-	0.1	μA
TC source current		ITCSCE	VCC=5V, V _{TC} =0V	2.0	3.0	5.0	μA	

Timing Chart

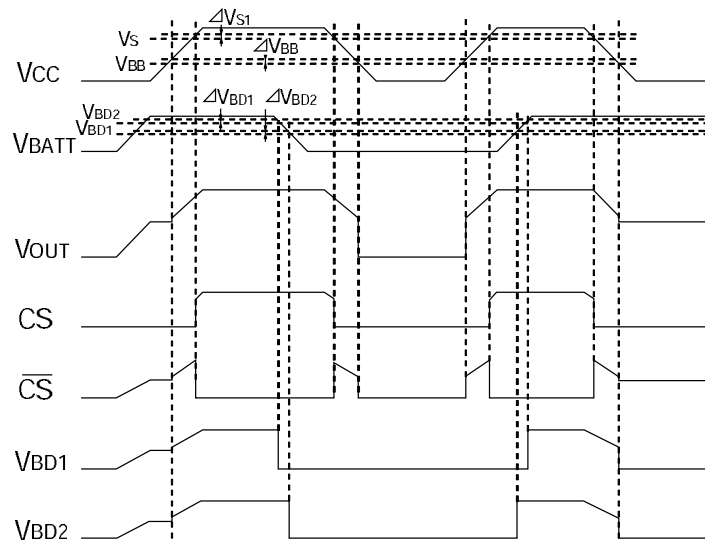

Application Circuits (Example : MM1027XV)

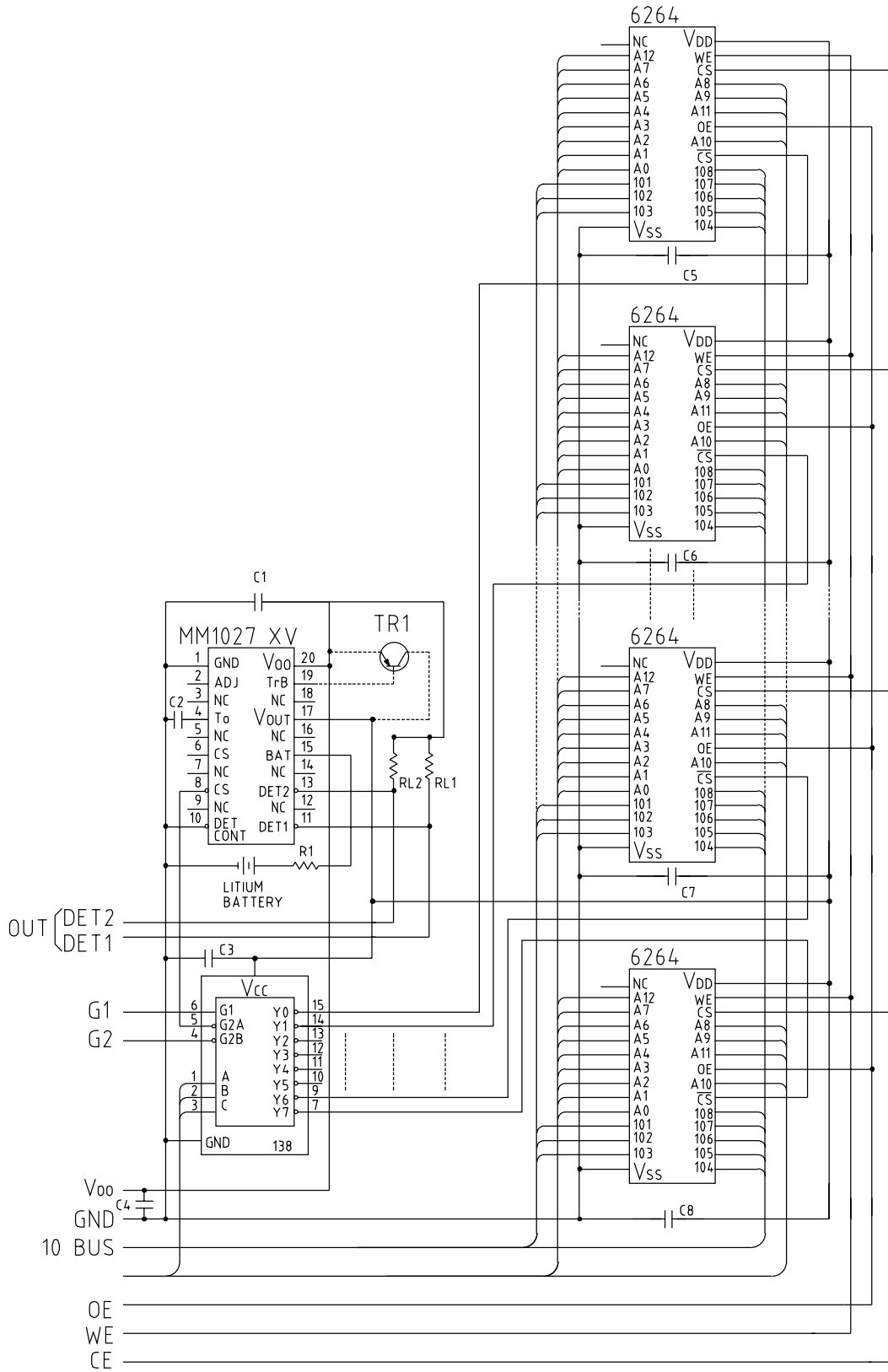

Characteristics (MM1027X)

■ CS pin ON delay time Vs. Capacitance

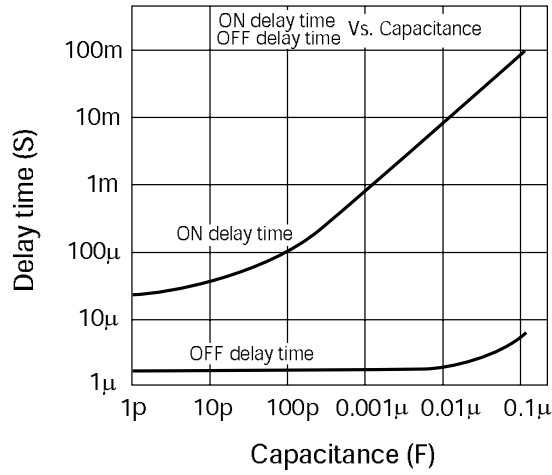

Note : CS and $\overline{\text{CS}}$ output waveforms may be disturbed if delay time is more than 10mS.

Characteristics (MM1027 series)

■ Current consumption

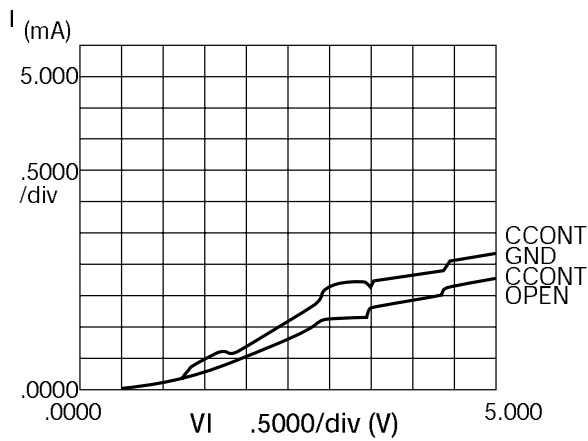

■ Loss current during back-up

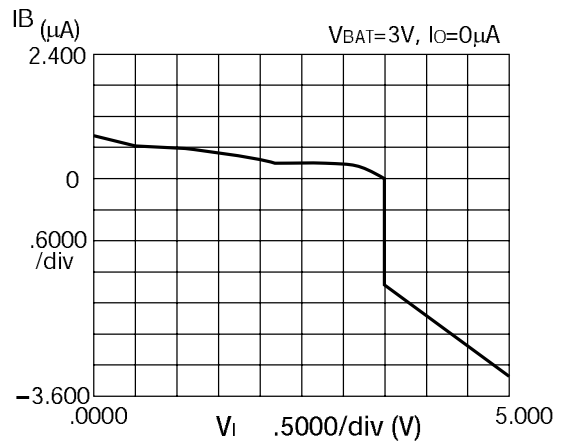

■ Output voltage 1

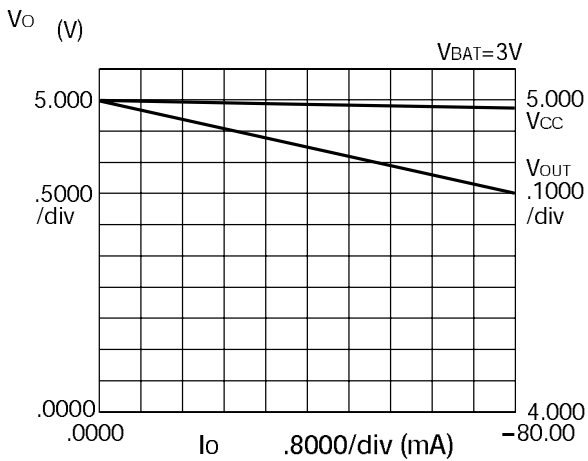

■ Shot key barrier diode reverse current

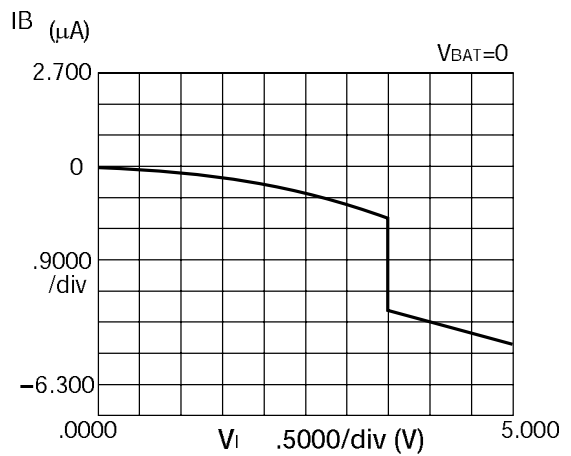

■ Output voltage 2 3

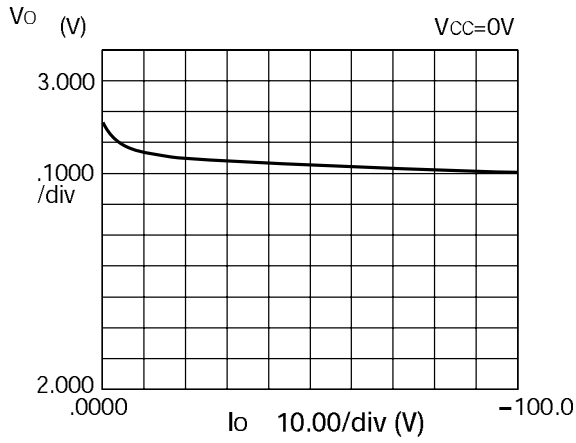

■ $I_{CS}-V_{CS}$ 1

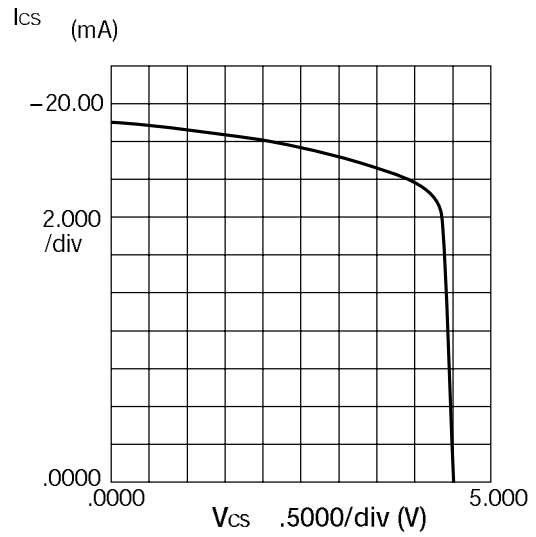

CS pin
Sink current
 $V_{CC}=4.5V$
 $V_{CS}=\text{Variable}$

■ $I_{CS}-V_{CS}$ 2

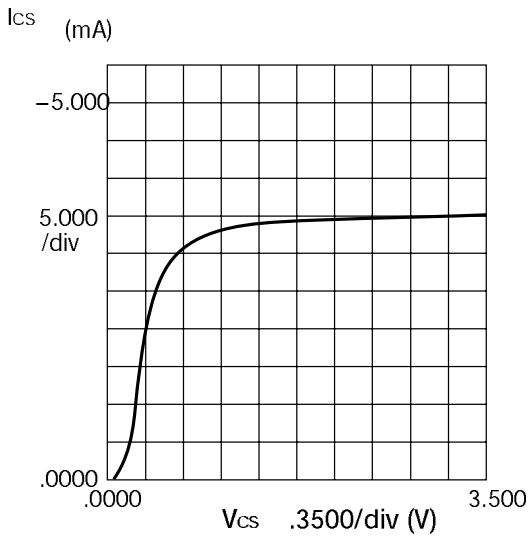

CS pin
Sink current
 $V_{CC}=3.5V$
 $V_{CS}=\text{Variable}$

■ $I_{\overline{CS}}-V_{\overline{CS}}$

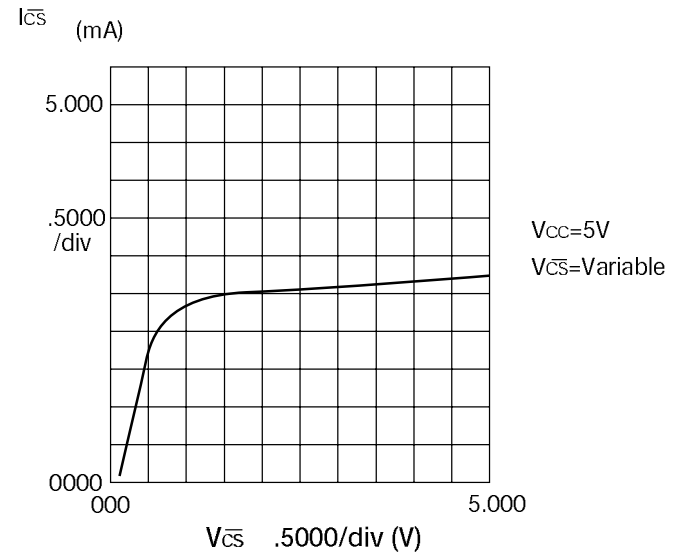

$V_{CC}=5V$
 $V_{\overline{CS}}=\text{Variable}$

■ ON delay time-Temperature

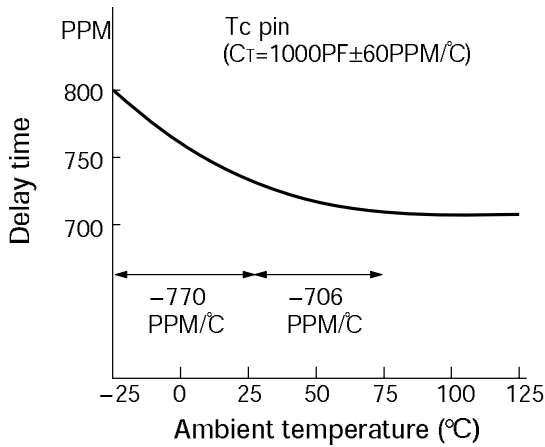

■ CS detection voltage adjustment (ADJ pin)

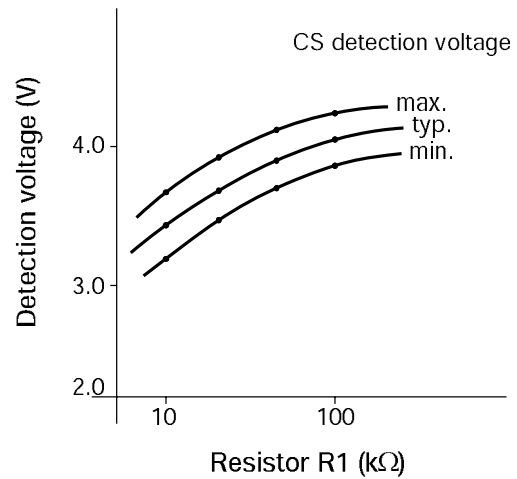

How to Adjust Detection Voltage Vs1

1. Connecting a resistor between ADJ pin and Vcc pin (effective only when lowering detection voltage)

Calculated min. and max. values take into account resistance, etc. variance inside the IC.

Refer to Figure 1

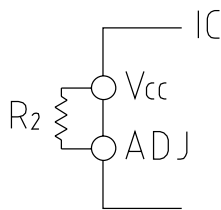

2. Using resistors to divide Vcc potential and connect to ADJ pin

Detection voltage can be determined close to external resistance value by setting external R2 and R3 values small.

Refer to Figure 2

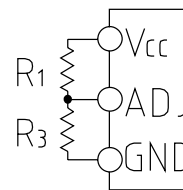

(However, current increases when R2 and R3 are made smaller, so set at around $R_2+R_3=6k\Omega$.)

■ CS detection voltage adjustment (ADJ pin)

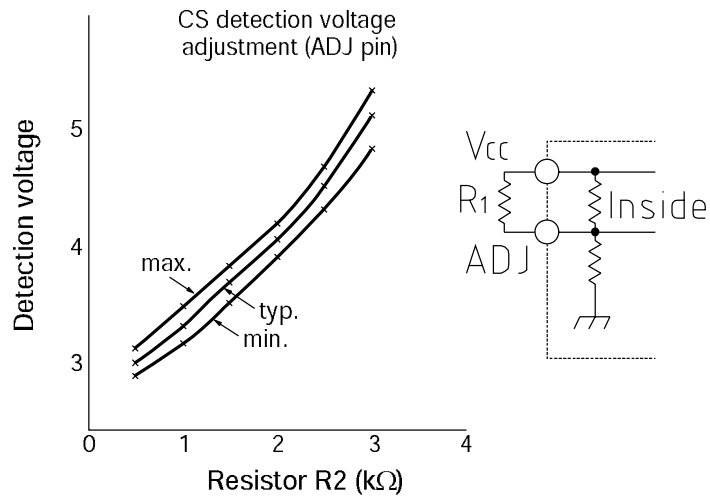

■ CS Output

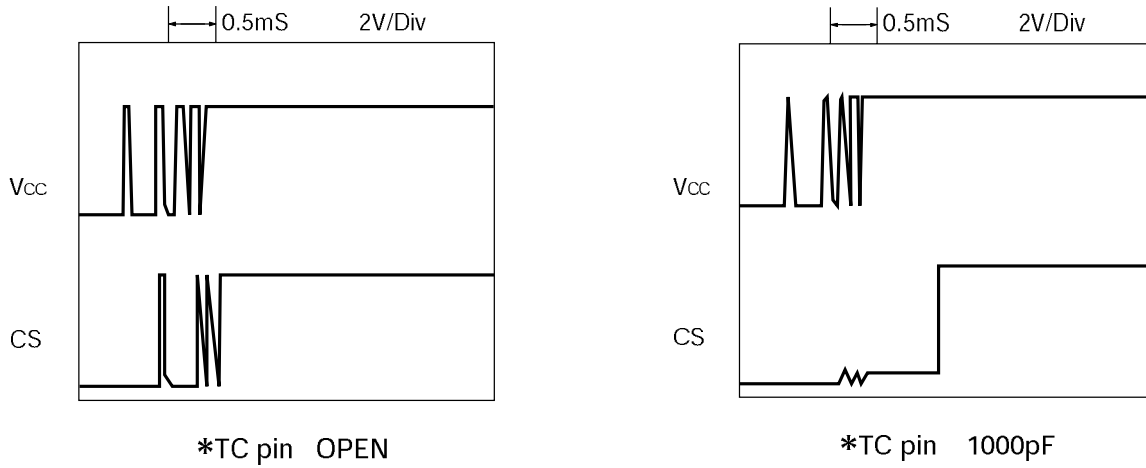

■ $\overline{\text{CS}}$ Output

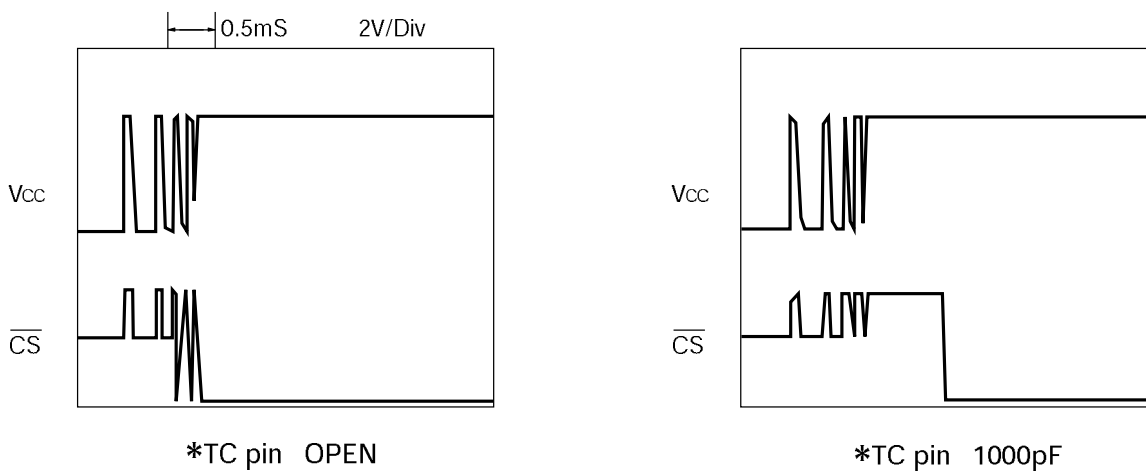

Characteristics (MM1081 series)

■ Input/output voltage difference 1 (V_{CC}=5.0V)

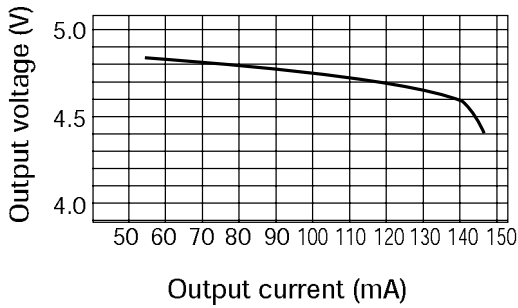

■ CS- $\overline{\text{CS}}$ detection voltage-Temperature

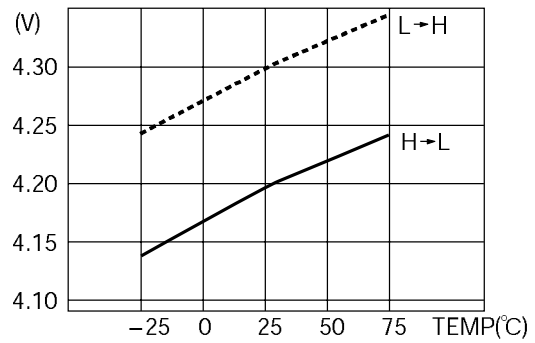

■ V_{CC}-I_{CC}

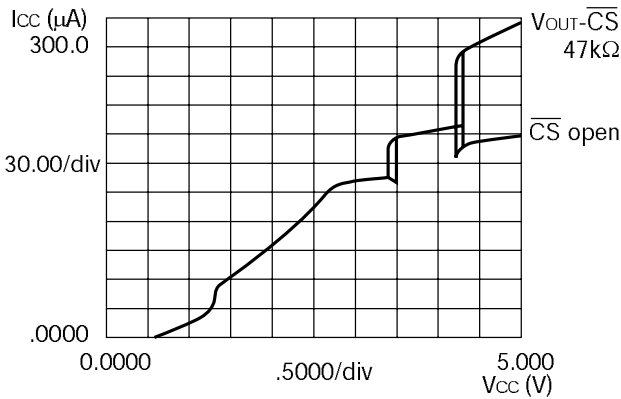

■ Power supply switching voltage-Temperature

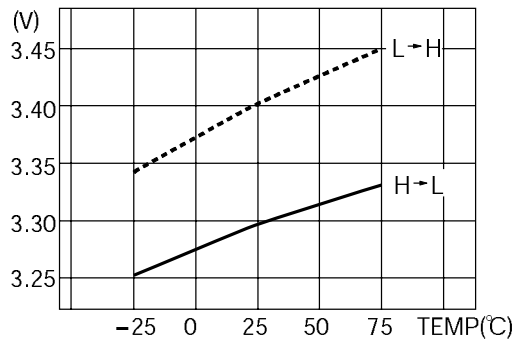

Timing Chart

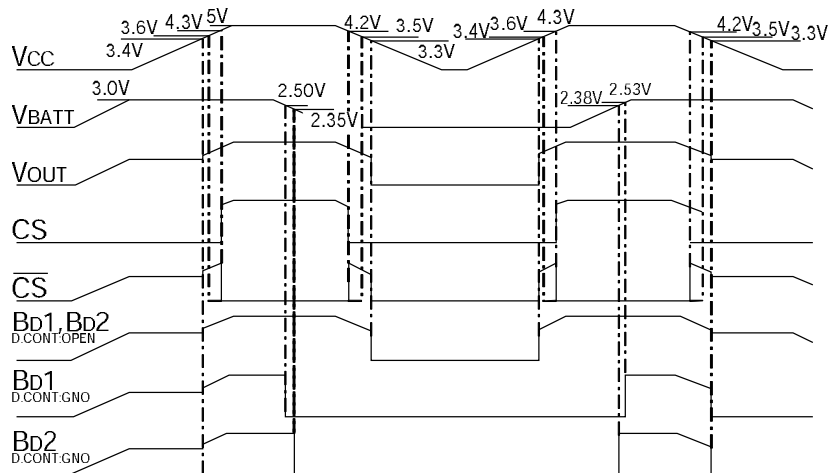

The broken lines for CS and $\overline{\text{CS}}$ indicate timing when the ADJ pin is pulled up to V_{CC} by 12k Ω .