

Pb Free Plating Product

MM60F120B



60 Ampere, 1200 Volt SwitchMode Single Fast Recovery Epitaxial Diode

APPLICATION

- Freewheeling, Snubber, Clamp
- Inversion Welder
- PFC
- Plating Power Supply
- Ultrasonic Cleaner and Welder
- Converter & Chopper
- UPS

PRODUCT FEATURE

- Ultrafast Recovery Time
- Soft Recovery Characteristics
- Low Recovery Loss
- Low Forward Voltage
- High Surge Current Capability
- Low Leakage Current

TO-247-2L

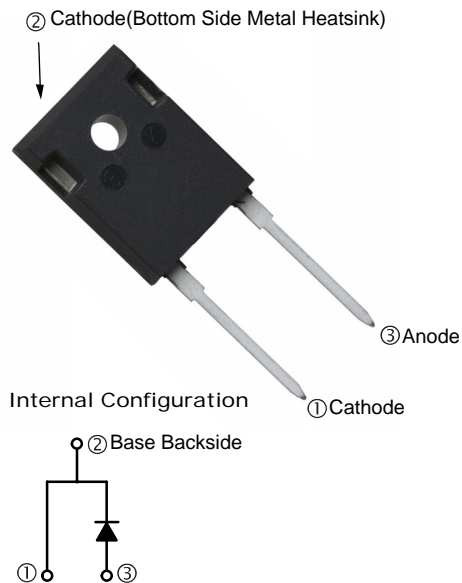

GENERAL DESCRIPTION

MM60F120B using the latest FRED FAB process(planar passivation chip) with ultrafast and soft recovery characteristic.

ABSOLUTE MAXIMUM RATINGS

 $T_C=25^{\circ}\text{C}$ unless otherwise specified

Symbol	Parameter	Test Conditions	Values	Unit
V_R	Maximum D.C. Reverse Voltage		1200	V
V_{RRM}	Maximum Repetitive Reverse Voltage		1200	V
$I_{F(AV)}$	Average Forward Current	$T_C=110^{\circ}\text{C}$	60	A
$I_{F(RMS)}$	RMS Forward Current	$T_C=110^{\circ}\text{C}$	84	A
I_{FSM}	Non-Repetitive Surge Forward Current	$T_J=45^{\circ}\text{C}$, $t=10\text{ms}$, 50Hz, Sine	500	A
P_D	Power Dissipation		312	W
T_J	Junction Temperature		-40 to +150	$^{\circ}\text{C}$
T_{STG}	Storage Temperature Range		-40 to +150	$^{\circ}\text{C}$
Torque	Module-to-Sink	Recommended (M3)	1.1	N-m
$R_{\theta JC}$	Thermal Resistance	Junction-to-Case	0.4	$^{\circ}\text{C}/\text{W}$
Weight			6.0	g

ELECTRICAL CHARACTERISTICS

 $T_C=25^{\circ}\text{C}$ unless otherwise specified

Symbol	Parameter	Test Conditions	Min.	Typ.	Max.	Unit
I_{RM}	Reverse Leakage Current	$V_R=1200\text{V}$	--	--	500	μA
		$V_R=1200\text{V}$, $T_J=125^{\circ}\text{C}$	--	--	5	mA
V_F	Forward Voltage	$I_F=60\text{A}$	--	2.10	--	V
		$I_F=60\text{A}$, $T_J=125^{\circ}\text{C}$	--	1.75	--	V
t_{rr}	Reverse Recovery Time	$I_F=1\text{A}$, $V_R=30\text{V}$, $di_F/dt=-200\text{A}/\mu\text{s}$	--	40	--	ns
t_{rr}	Reverse Recovery Time	$V_R=600\text{V}$, $I_F=60\text{A}$	--	90	--	ns
I_{RRM}	Max. Reverse Recovery Current	$di_F/dt=-200\text{A}/\mu\text{s}$, $T_J=25^{\circ}\text{C}$	--	7.5	--	A
t_{rr}	Reverse Recovery Time	$V_R=600\text{V}$, $I_F=60\text{A}$	--	320	--	ns
I_{RRM}	Max. Reverse Recovery Current	$di_F/dt=-200\text{A}/\mu\text{s}$, $T_J=125^{\circ}\text{C}$	--	14	--	A

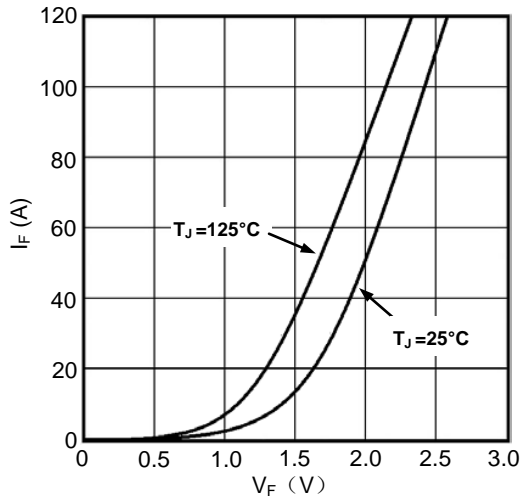

Figure1. Forward Voltage Drop vs Forward Current

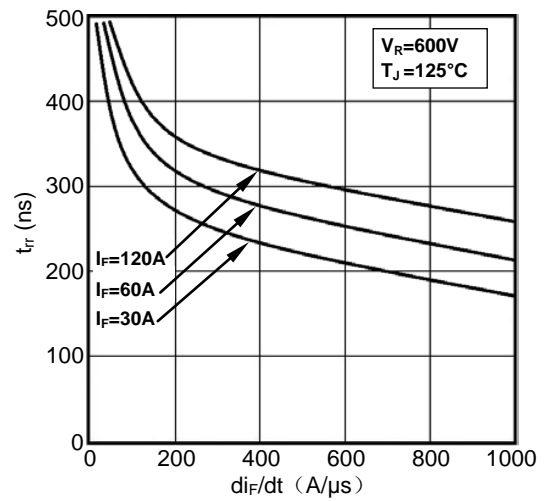

Figure2. Reverse Recovery Time vs di_F/dt

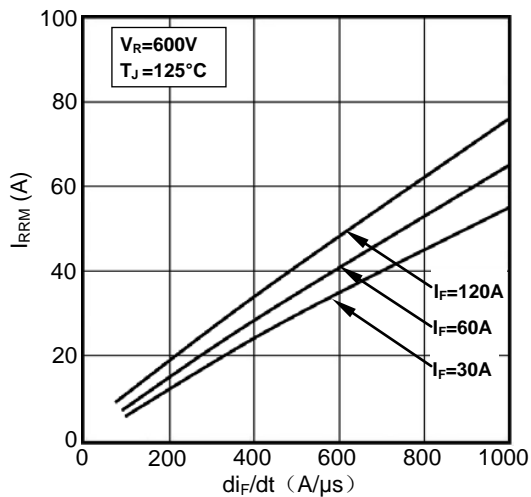

Figure3. Reverse Recovery Current vs di_F/dt

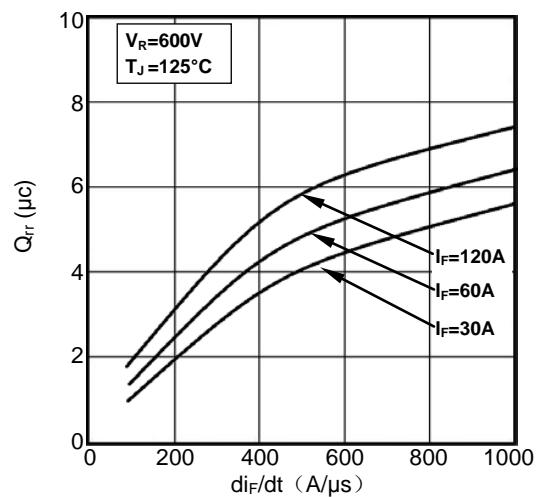

Figure4. Reverse Recovery Charge vs di_F/dt

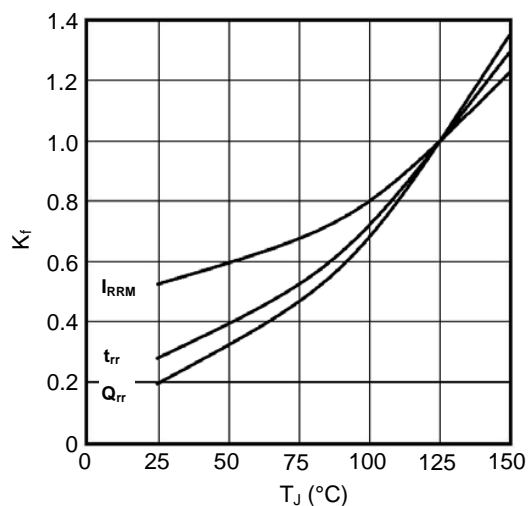

Figure5. Dynamic Parameters vs Junction Temperature

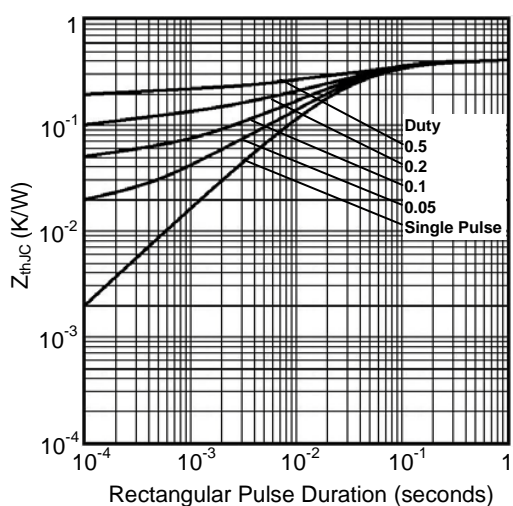

Figure6. Transient Thermal Impedance

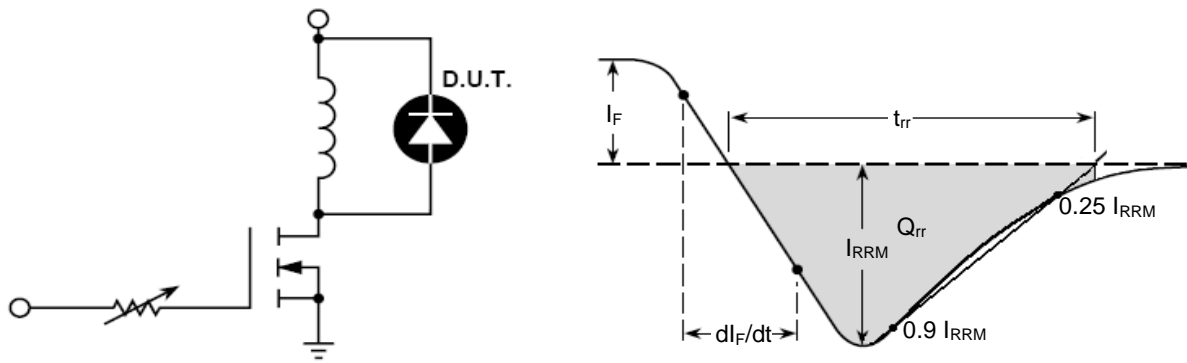
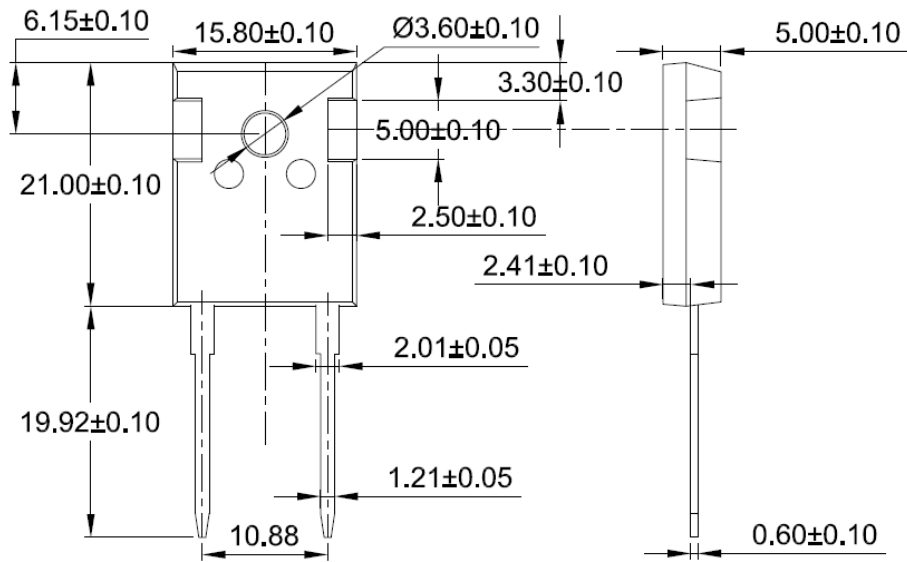

Fig7. Diode Reverse Recovery Test Circuit and Waveform



Dimensions in Millimeters
Fig8. Package Outline