

## Small Signal Product

### 350mW, SMD Switching Diode

**FEATURES**

- Fast switching speed
- Surface mount device type
- Moisture sensitivity level 1
- Matte Tin (Sn) lead finish with Nickel (Ni) underplate
- Pb free version and RoHS compliant
- Packing code with suffix "G" means green compound (halogen-free)

**SOT-23**

**MECHANICAL DATA**

- Case: SOT-23 small outline plastic package
- Terminal: Matte tin plated, lead free., solderable per MIL-STD-202, Method 208 guaranteed
- High temperature soldering guaranteed : 260°C/10s
- Weight: 8 ± 0.5 mg

MAXIMUM RATINGS AND ELECTRICAL CHARACTERISTICS (T <sub>A</sub> =25°C unless otherwise noted)			
PARAMETER	SYMBOL	VALUE	UNIT
Power Dissipation	P <sub>D</sub>	350	mW
Repetitive Peak Reverse Voltage	V <sub>RRM</sub>	350	V
Repetitive Peak Forward Current	I <sub>FRM</sub>	625	mA
Mean Forward Current	I <sub>O</sub>	225	mA
Non-Repetitive Peak Forward Surge Current	I <sub>FSM</sub>	4 1	A
		Pulse Width=1μs Pulse Width=1s	
Thermal Resistance (Junction to Ambient)	R <sub>θJA</sub>	357	°C/W
Junction and Storage Temperature Range	T <sub>J</sub> , T <sub>STG</sub>	-65 to +150	°C

PARAMETER	SYMBOL	MIN	MAX	UNIT
Reverse Breakdown Voltage	I <sub>R</sub> =100μA V <sub>(BR)</sub>	350	-	V
Forward Voltage	I <sub>F</sub> =100mA V <sub>F</sub>	-	1.00	V
	I <sub>F</sub> =200mA	-	1.25	
Reverse Leakage Current	V <sub>R</sub> =240V I <sub>R</sub>	-	0.1	μA
	V <sub>R</sub> =240V, T <sub>J</sub> =150°C	-	100	
Junction Capacitance	V <sub>R</sub> =1V, f=1.0MHz C <sub>J</sub>	-	5	pF
Reverse Recovery Time	I <sub>F</sub> =I <sub>R</sub> =30mA, R <sub>L</sub> =100Ω, I <sub>RR</sub> =0.1I <sub>R</sub> t <sub>rr</sub>	-	50	ns

Small Signal Product

RATINGS AND CHARACTERISTICS CURVES

( $T_A=25^\circ\text{C}$  unless otherwise noted)

Fig. 1 Typical Forward Characteristics

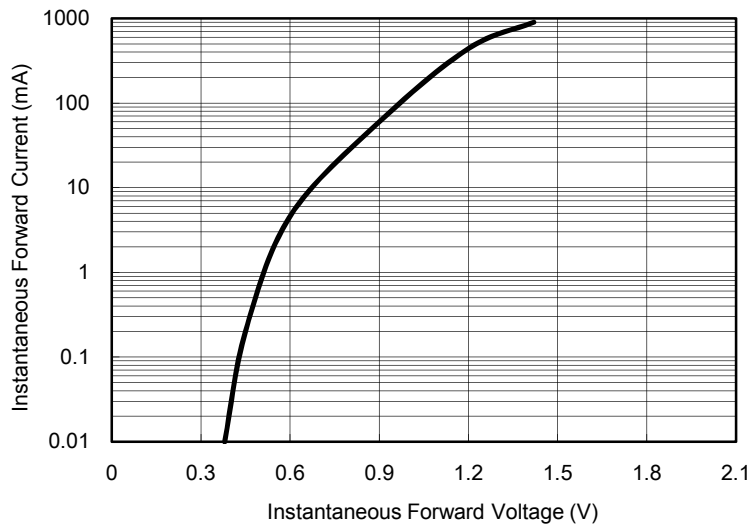

Fig. 2 Typical Reverse Characteristics

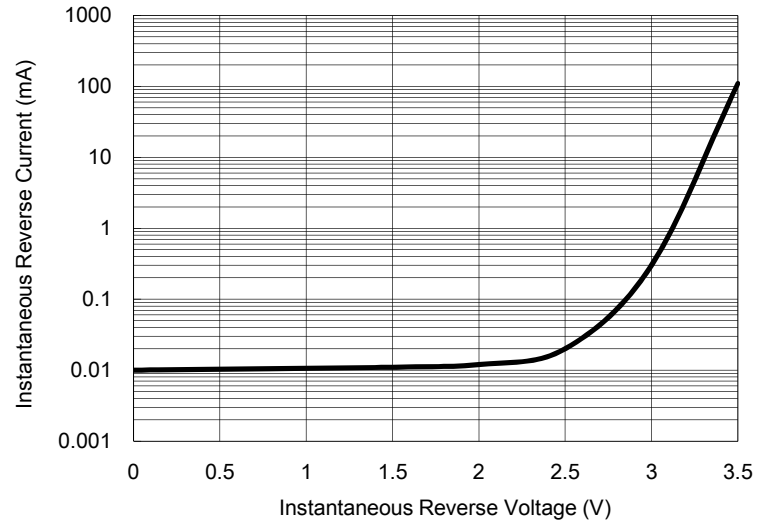

Fig. 3 Admissible Power Dissipation Curve

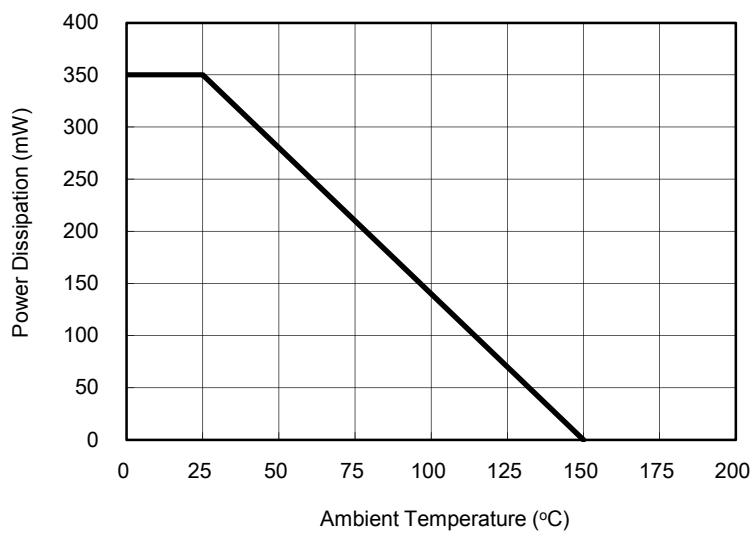
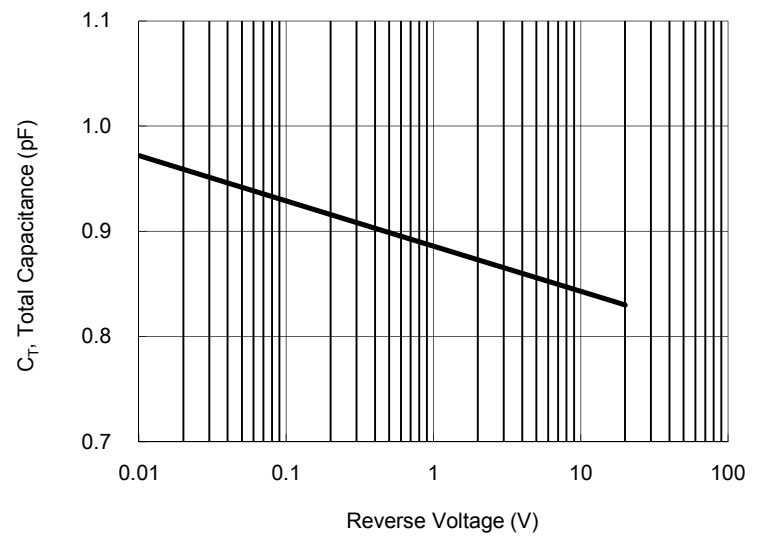

Fig. 4 Typical Capacitance VS. Reverse Voltage



Small Signal Product

ORDER INFORMATION (EXAMPLE)

MMBD3004 RFG

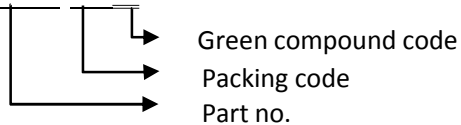

PACKAGE OUTLINE DIMENSIONS  
**SOT-23**

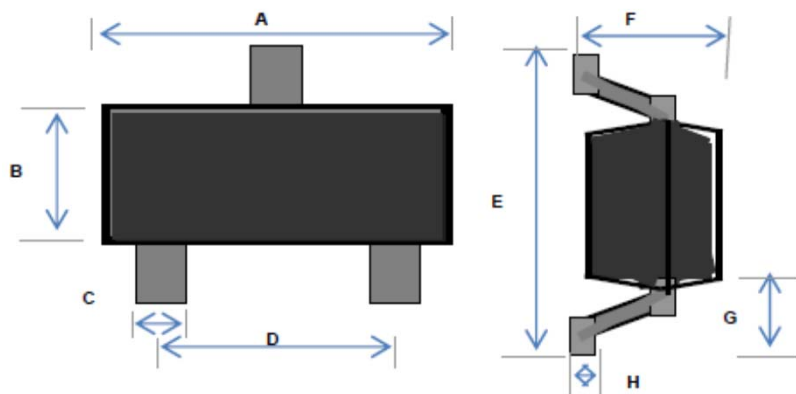

DIM.	Unit (mm)		Unit (inch)	
	Min	Max	Min	Max
A	2.70	3.10	0.106	0.122
B	1.10	1.50	0.043	0.059
C	0.30	0.51	0.012	0.020
D	1.78	2.04	0.070	0.080
E	2.10	2.64	0.083	0.104
F	0.89	1.30	0.035	0.051
G	0.55 REF		0.022 REF	
H	0.10 REF		0.004 REF	

SUGGEST PAD LAYOUT

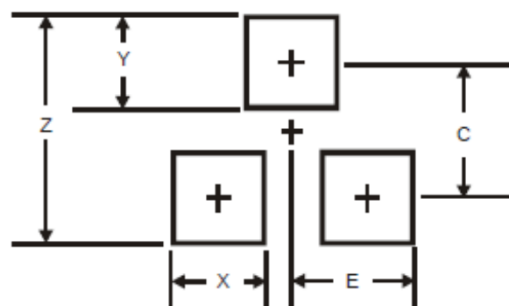

DIM.	Unit (mm)		Unit (inch)	
	Typ.		Typ.	
Z	2.8		0.110	
X	0.7		0.028	
Y	0.9		0.035	
C	1.9		0.075	
E	1.0		0.039	

PIN CONFIGURATION

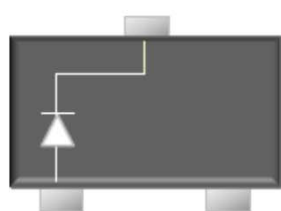

**MMBD3004**

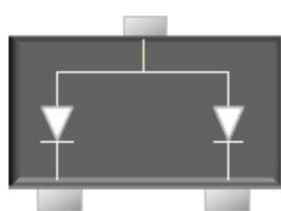

**MMBD3004CA**

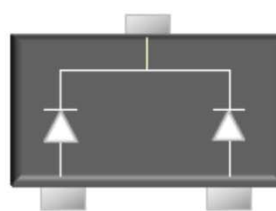

**MMBD3004CC**

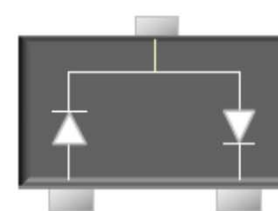

**MMBD3004SE**

MARKING

Part No.	Marking
MMBD3004	HC
MMBD3004CA	RA
MMBD3004CC	PZ
MMBD3004SE	PY

Small Signal Product

### Notice

Specifications of the products displayed herein are subject to change without notice. TSC or anyone on its behalf, assumes no responsibility or liability for any errors or inaccuracies.

Information contained herein is intended to provide a product description only. No license, express or implied, to any intellectual property rights is granted by this document. Except as provided in TSC's terms and conditions of sale for such products, TSC assumes no liability whatsoever, and disclaims any express or implied warranty, relating to sale and/or use of TSC products including liability or warranties relating to fitness for a particular purpose, merchantability, or infringement of any patent, copyright, or other intellectual property right.

The products shown herein are not designed for use in medical, life-saving, or life-sustaining applications. Customers using or selling these products for use in such applications do so at their own risk and agree to fully indemnify TSC for any damages resulting from such improper use or sale.