

PRODUCT FEATURES

- $R_{DS(ON),typ}=0.45m\Omega@V_{GS}=10V$
- 175°C operating temperature
- Low Gate Charge Minimize Switching Loss
- Fast Recovery body Diode
- 10K Ω Gate Protected Resistance Inside
- Inside the module, each MOSFET chip has a gate resistance: 10 Ω



APPLICATIONS

- High efficiency DC/DC Converters
- Synchronous Rectifier

Type	V _{DS}	I _D	R _{DS(ON),max} T _J =25°C	T _{Jmax}	Marking	Package
MMN600DB012B	120V	600A	0.6m Ω	175°C	MMN600DB012B	NDB

ABSOLUTE MAXIMUM RATINGS (T_C=25°C unless otherwise specified)

Symbol	Parameter/Test Conditions		Values	Unit
V _{DSS}	Drain - Source Voltage	T _J =25°C	120	V
V _{GSS}	Gate - Source Voltage		±20	
I _D	Continuous Drain Current	T _C =25°C	905	A
		T _C =110°C	600	
I _{DM}	Pulsed Drain Current at V _{GS} =10V	Limited by T _{Jmax}	1200	
P _D	Maximum Power Dissipation		1500	W
E _{AS}	Single Pulse Avalanche Energy	V _{DD} =50V, L=1mH	7200	mJ

THERMAL AND MODULE CHARACTERISTICS (T_C=25°C unless otherwise specified)

Symbol	Parameter/Test Conditions		Values	Unit
R _{thJC}	Thermal resistance, junction to case Per MOSFET		0.1	K/W
T _{Jmax}	Max. Junction Temperature		175	°C
T _{STG}	Storage Temperature Range		-40~125	
V _{isol}	Isolation Breakdown Voltage	AC, 50Hz(R.M.S), t=1minute	3000	V
Torque	to heatsink	Recommended (M5)	2.5~5	Nm
	to terminal	Recommended (M5)	2.5~5	
Weight			240	g

MacMic Science & Technology Co., Ltd.

Add: #18, Hua Shan Zhong Lu, New District, Changzhou City, Jiangsu Province, P. R. of China

Tel.: +86-519-85163708 Fax: +86-519-85162291 Post Code: 213022 Website: www.macmicst.com

MMN600DB012B

MOSFET

ELECTRICAL CHARACTERISTICS ($T_C=25^\circ\text{C}$ unless otherwise specified)

Symbol	Parameter/Test Conditions		Min.	Typ.	Max.	Unit	
$V_{(BR)DSS}$	Drain Source Breakdown Voltage	$V_{GS}=0V, I_D=2mA$	120			V	
$R_{DS(ON)}$	Drain Source ON Resistance	$V_{GS}=10V, I_D=600A(\text{chip})$		0.45	0.6	m Ω	
I_{DSS}	Drain Source Leakage Current	$V_{DS}=120V, V_{GS}=0V$			2	mA	
$V_{GS(th)}$	Gate Threshold Voltage	$V_{GS}=V_{DS}, I_D=2mA$	3.0		5.0	V	
I_{GSS}	Gate Leakage Current	$V_{DS}=0V, V_{GS}=\pm 20V$	-2		2	mA	
R_{gint}	Integrated Gate Resistor			1.5		Ω	
Q_g	Total Gate Charge	$V_{DD}=60V, I_D=600A, V_{GS}=10V$		1264	1690	nC	
Q_{gs}	Gate Source Charge			416		nC	
Q_{gd}	Gate Drain Charge			296		nC	
C_{iss}	Input Capacitance			86		nF	
C_{oss}	Output Capacitance	$V_{DS}=25V, V_{GS}=0V, f=1MHz$		23.5		nF	
C_{rss}	Reverse Transfer Capacitance			2.35		nF	
$t_{d(on)}$	Turn on Delay Time	$V_{DD}=60V, I_D=300A, R_G=5\Omega, V_{GS}=10V, (\text{Inductive Load})$	$T_J=25^\circ\text{C}$		264		ns
t_r	Rise Time				200		ns
$t_{d(off)}$	Turn off Delay Time				395		ns
t_f	Fall Time				156		ns

Source-Drain BODY-DIODE CHARACTERISTICS ($T_C=25^\circ\text{C}$ unless otherwise specified)

Symbol	Parameter/Test Conditions		Min.	Typ.	Max.	Unit
I_{SD}	Continuous Source Drain Current				600	A
I_{SDM}	Pulse Source Drain Current	Limited by T_{Jmax}			1200	A
V_{SD}	Forward Voltage	$I_S=600A, V_{GS}=0V$		0.9	1.2	V
t_{rr}	Reverse Recovery time	$I_F=300A, V_{GS}=0V$		162		ns
Q_{RR}	Reverse Recovery Charge	$dI_F/dt=-1000A/\mu s$		6900		nC

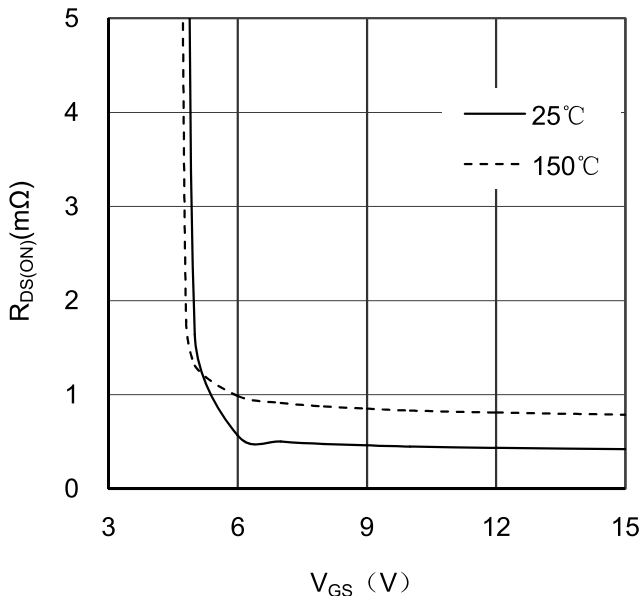

Figure 1. Typical $R_{DS(ON)}$ vs Gate Voltage

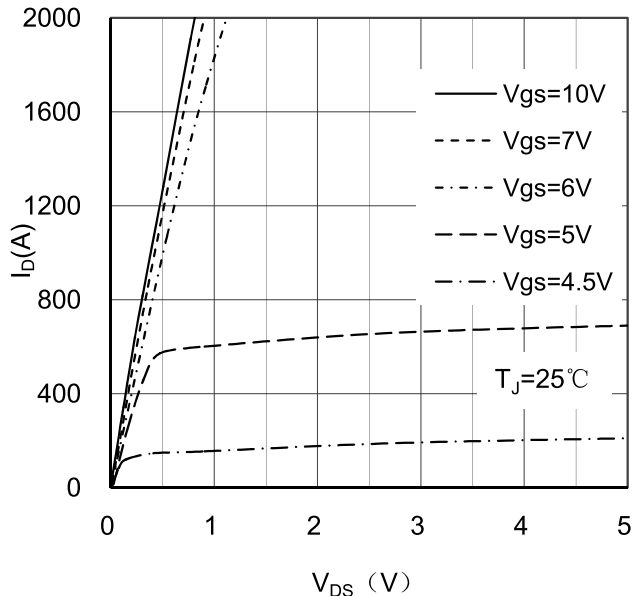

Figure 2. Typical Output Characteristics

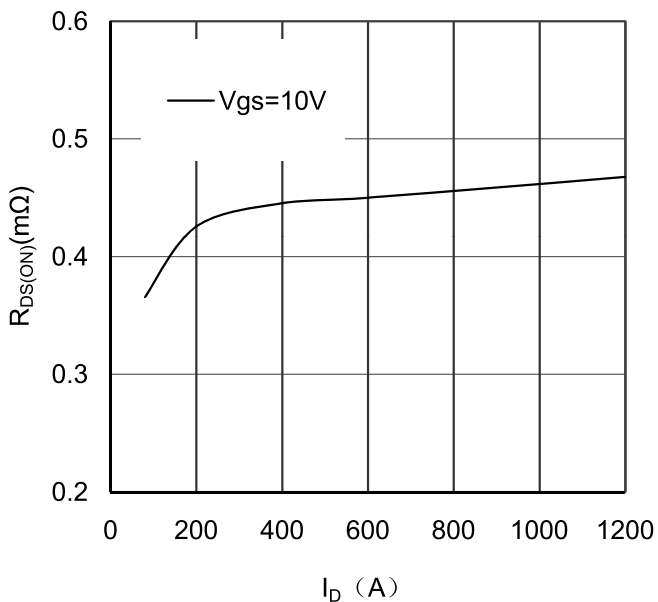

Figure 3. Drain-Source ON Resistance vs I_D

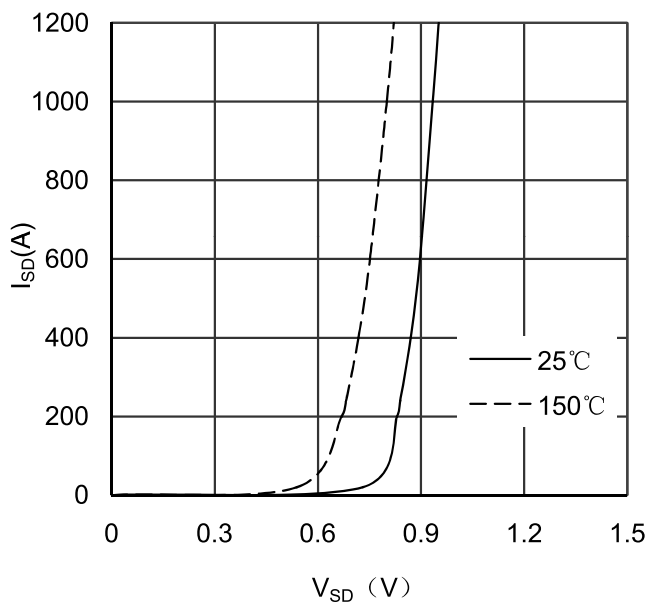

Figure 4. Source-Drain Voltage

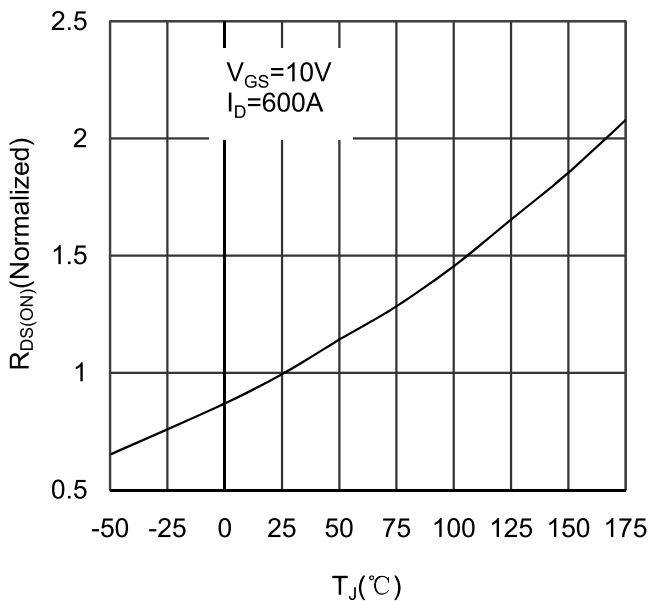

Figure 5. Drain-Source ON Resistance vs Junction Temperature

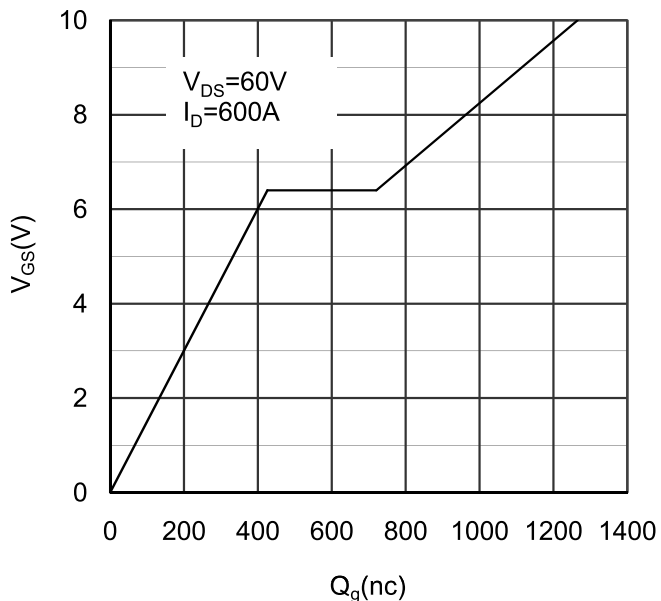

Figure 6. Gate Charge characteristics

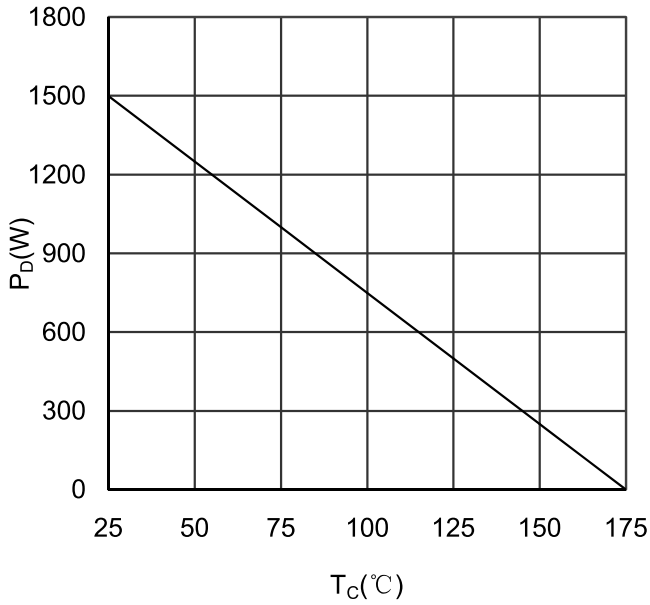

Figure 7. Maximum Power Dissipation vs Case Temperature

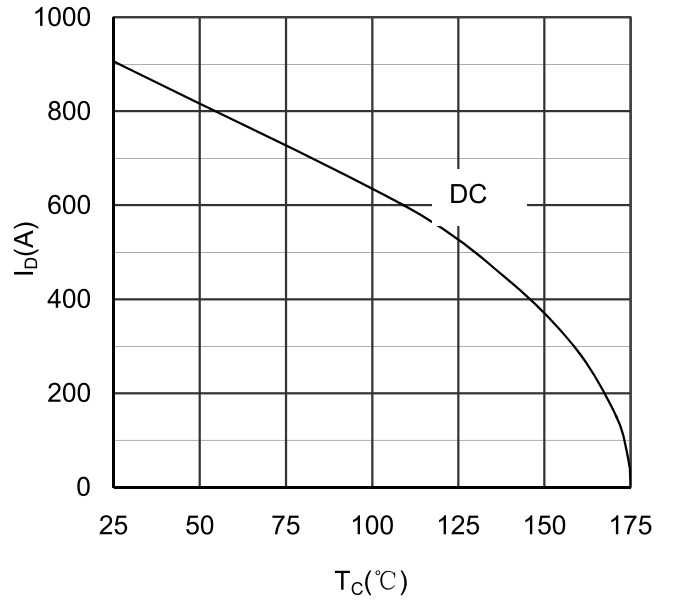

Figure 8. Maximum Continuous Drain Current vs Case Temperature

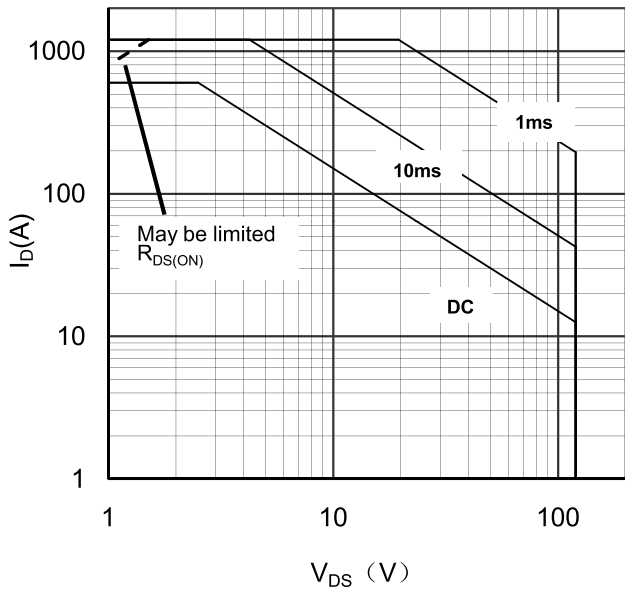

Figure 9. Maximum Forward Safe Operation Area

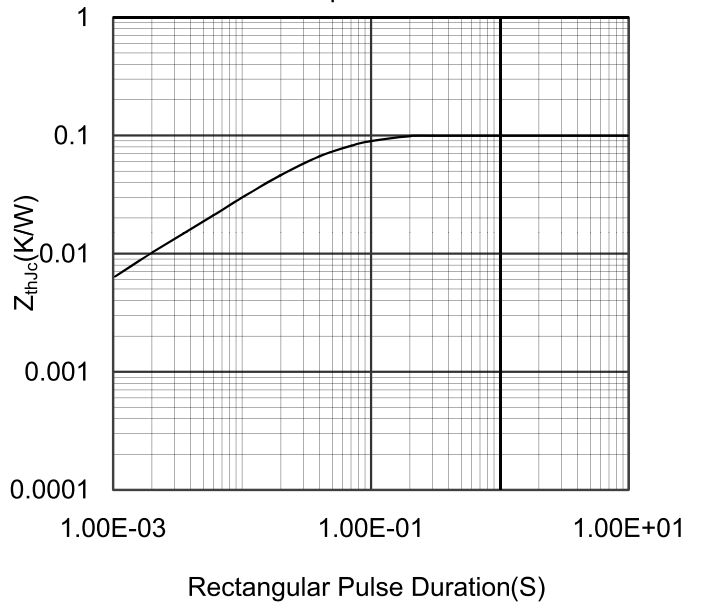

Figure 10. Transient Thermal Impedance

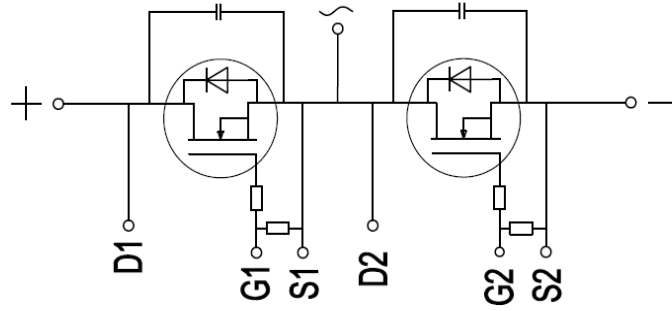
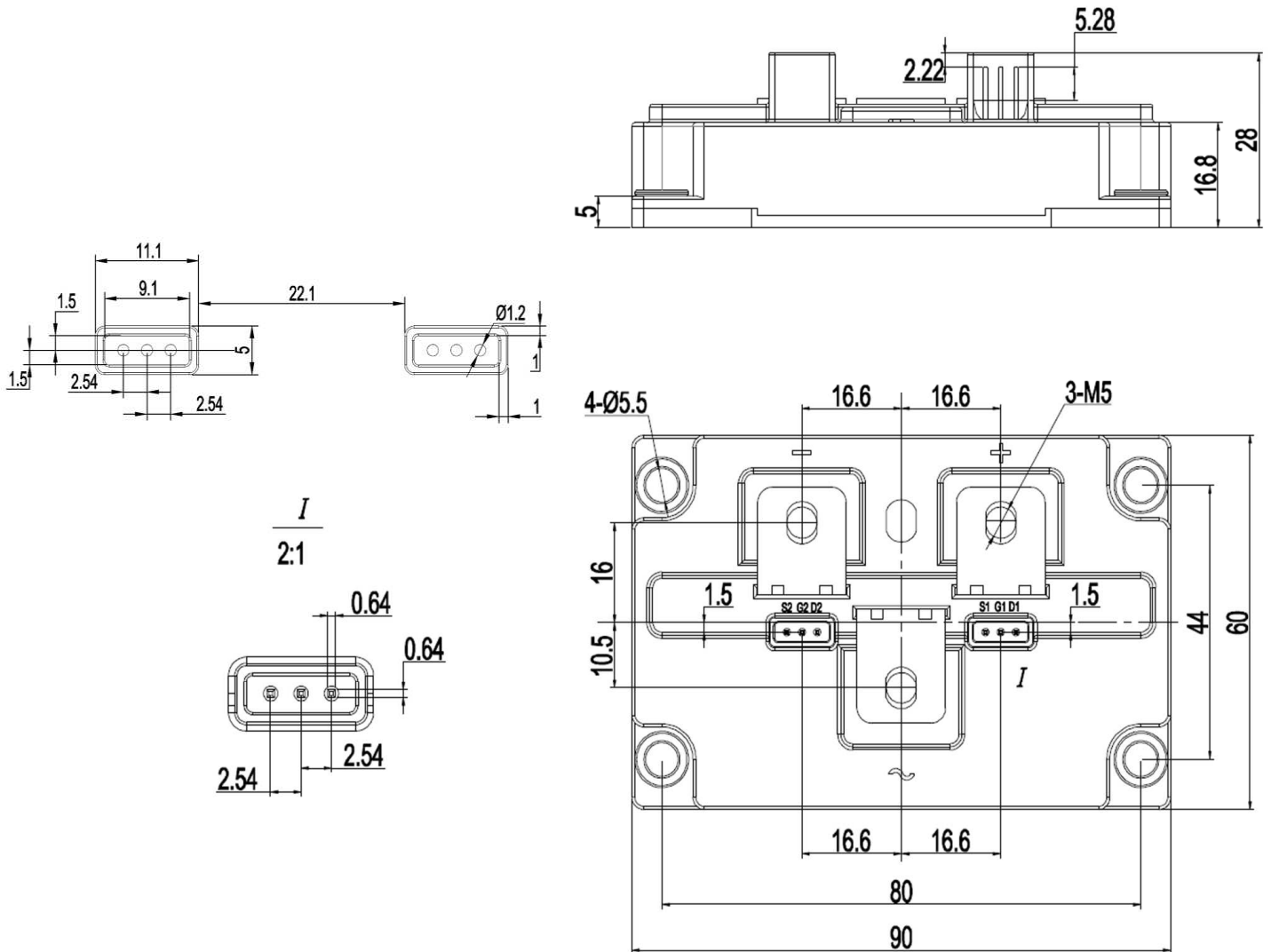

Figure 11. Circuit Diagram



Dimensions in (mm)
Figure 12. Package Outline