

FEATURES

- 500mW rating on FR-4 or FR-5 board
- Wide Zener reverse voltage range - 2.4V to 110V
- Package designed for optimal automated board assembly
- Small package size for high density applications
- General purpose, medium current
- ESD Rating of Class 3 (<16 kV) per human body model
- SZ prefix for automotive and other applications requiring unique site and control change requirements; AEC-Q101 qualified and PPAP capable
- These are Pb-Free devices

MECHANICAL

- Case: Void-free, transfer-molded, thermosetting plastic case
- Finish: Corrosion resistant finish, easily solderable
- Maximum Case Temp: 260°C for 10 seconds
- Polarity: Cathode indicated by polarity band
- Flammability rating: UL 94 V-0

MAXIMUM RATINGS

Rating at 25°C ambient temperature unless otherwise specified.

Parameter	Symbol	MMSZ52BT1G	Unit
Total Power Dissipation (Note 1) @ TL = 75°C Derated above 75°C	P _D	500 6.7	mW mW / °C
Typical Thermal Resistance Junction to Ambient (Note 2)	R _{θJA}	340	°C/W
Typical Thermal Resistance Junction to Lead (Note 2)	R _{θJL}	150	°C/W
Operating Temperature Range	T _J	-55 to +150	°C
Storage Temperature Range	T _{STG}	-55 to +150	°C

NOTE: 1. FR-5 = 3.5 x 1.5 inches, using the minimum recommended footprint.
2. Thermal resistance measurement obtained via infrared scan method.

ELECTRICAL CHARACTERISTICS - Zener Voltage Regulator

Symbol	Parameter
V _Z	Reverse Zener Voltage @ I _{ZT}
I _{ZT}	Reverse Current
Z _{ZT}	Maximum Zener Impedance @ I _{ZT}
I _{ZK}	Reverse Current
Z _{ZK}	Maximum Zener Impedance @ I _{ZK}
I _R	Reverse Leakage Current @ V _R
V _R	Reverse Voltage
I _F	Forward Current
V _F	Forward Voltage @ I _F

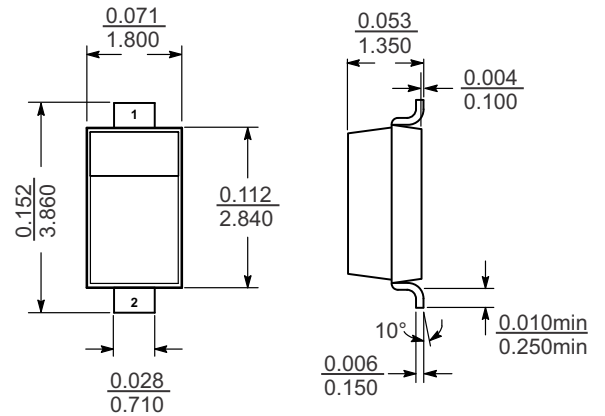
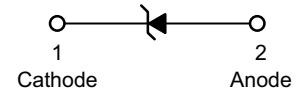
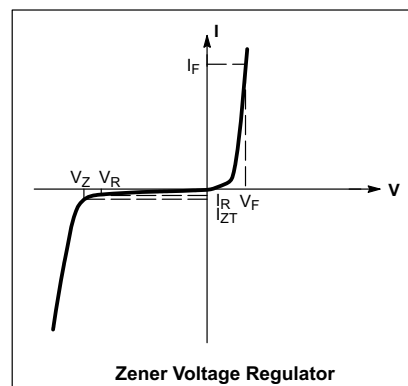

SOD-123
Dimensions in inches and (millimeters)

■ ELECTRICAL CHARACTERISTICS - 5% TOLERANCE (Cont'd)

@ Ta = 25°C unless otherwise specified, Vf = 0.9V max @ If = 10mA

Part Number*	Marking Code	Zener Voltage Range			Test Current	Maximum Zener Impedance			Maximum Reverse Leakage Current	
		Vz @ IzT				IzT	ZzT @ IzT	Zzk @ IzK = 0.25mA	IR	@ VR
		Norm (V)	Min (V)	Max (V)	mA	Ω	Ω	mA	µa	V
MMSZ5221B	C1	2.4	2.28	2.52	20	30	1200	0.25	100	1
MMSZ5222B	C2	2.5	2.38	2.63	20	30	1250	0.25	100	1
MMSZ5223B	C3	2.7	2.57	2.84	20	30	1300	0.25	75	1
MMSZ5224B	C4	2.8	2.66	2.94	20	30	1400	0.25	75	1
MMSZ5225B	C5	3	2.85	3.15	20	29	1600	0.25	50	1
MMSZ5226B	D1	3.3	3.14	3.47	20	28	1600	0.25	25	1
MMSZ5227B	D2	3.6	3.42	3.78	20	24	1700	0.25	15	1
MMSZ5228B	D3	3.9	3.71	4.1	20	23	1900	0.25	10	1
MMSZ5229B	D4	4.3	4.09	4.52	20	22	2000	0.25	5	1
MMSZ5230B	D5	4.7	4.47	4.94	20	19	1900	0.25	5	2
MMSZ5231B	E1	5.1	4.85	5.36	20	17	1600	0.25	5	2
MMSZ5232B	E2	5.6	5.32	5.88	20	11	1600	0.25	5	3
MMSZ5233B	E3	6	5.7	6.3	20	7	1600	0.25	5	3.5
MMSZ5234B	E4	6.2	5.89	6.51	20	7	1000	0.25	5	4
MMSZ5235B	E5	6.8	6.46	7.14	20	5	750	0.25	3	5
MMSZ5236B	F1	7.5	7.13	7.88	20	6	500	0.25	3	6
MMSZ5237B	F2	8.2	7.79	8.61	20	8	500	0.25	3	6.5
MMSZ5238B	F3	8.7	8.27	9.14	20	8	600	0.25	3	6.5
MMSZ5239B	F4	9.1	8.65	9.56	20	10	600	0.25	3	7
MMSZ5240B	F5	10	9.5	10.5	20	17	600	0.25	3	8
MMSZ5241B	H1	11	10.45	11.55	20	22	600	0.25	2	8.4
MMSZ5242B	H2	12	11.4	12.6	20	30	600	0.25	1	9.1
MMSZ5243B	H3	13	12.35	13.65	9.5	13	600	0.25	0.5	9.9
MMSZ5244B	H4	14	13.3	14.7	9	15	600	0.25	0.1	10
MMSZ5245B	H5	15	14.25	15.75	8.5	16	600	0.25	0.1	11
MMSZ5246B	J1	16	15.2	16.8	7.8	17	600	0.25	0.1	12
MMSZ5247B	J2	17	16.15	17.85	7.4	19	600	0.25	0.1	13
MMSZ5248B	J3	18	17.1	18.9	7	21	600	0.25	0.1	14
MMSZ5249B	J4	19	18.05	19.95	6.6	23	600	0.25	0.1	14
MMSZ5250B	J5	20	19	21	6.2	25	600	0.25	0.1	15
MMSZ5251B	K1	22	20.9	23.1	5.6	29	600	0.25	0.1	17
MMSZ5252B	K2	24	22.8	25.2	5.2	33	600	0.25	0.1	18
MMSZ5253B	K3	25	23.75	26.25	5	35	600	0.25	0.1	19
MMSZ5254B	K4	27	25.65	28.35	4.6	41	600	0.25	0.1	21
MMSZ5255B	K5	28	26.6	29.4	4.5	44	600	0.25	0.1	21
MMSZ5256B	M1	30	28.5	31.5	4.2	49	600	0.25	0.1	23
MMSZ5257B	M2	33	31.35	34.65	3.8	58	700	0.25	0.1	25
MMSZ5258B	M3	36	34.2	37.8	3.4	70	700	0.25	0.1	27
MMSZ5259B	M4	39	37.05	40.95	3.2	80	800	0.25	0.1	30

NOTE: 1. "B" Suffix type numbers shown have a standard tolerance of ± 5% on the nominal zener voltages.
 2. Nominal zener voltage is measured with the device junction in thermal equilibrium at TL = 30°C ± 1°C.
 3. ZzT and Zzk are measured by dividing the AC voltage drop across the device by the ac current applied.
 The specified limits are for Iz(AC) = 0.1 Iz(DC) with the AC frequency = 1 kHz.
 4. Use SZ prefix for AEC-Q101

ELECTRICAL CHARACTERISTICS - 5% TOLERANCE (Cont'd)

@ Ta = 25°C unless otherwise specified, Vf = 0.9V max @ If = 10mA

Part Number*	Marking Code	Zener Voltage Range			Test Current	Maximum Zener Impedance			Maximum Reverse Leakage Current	
		Vz @ IzT				IzT	ZzT @ IzT	Zzk @ Izk = 0.25mA	IR	@ VR
		Norm (V)	Min (V)	Max (V)	mA	Ω	Ω	mA	µa	V
MMSZ5260B	M5	43	40.85	45.15	3	93	900	0.25	0.1	33
MMSZ5261B	N1	47	44.65	49.35	2.7	105	1000	0.25	0.1	36
MMSZ5262B	N2	51	48.45	53.55	2.5	125	1100	0.25	0.1	39
MMSZ5263B	N3	56	53.2	58.8	2.2	150	1300	0.25	0.1	43
MMSZ5264B	N4	60	57	63	2.1	170	1400	0.25	0.1	46
MMSZ5265B	N5	62	58.9	65.1	2	185	1400	0.25	0.1	47
MMSZ5266B	P1	68	64.6	71.4	1.8	230	1600	0.25	0.1	52
MMSZ5267B	P2	75	71.25	78.75	1.7	270	1700	0.25	0.1	56
MMSZ5268B	P3	82	77.9	86.1	1.5	330	2000	0.25	0.1	62
MMSZ5269B	P4	87	82.65	91.35	1.4	370	2200	0.25	0.1	68
MMSZ5270B	P5	91	86.45	95.55	1.4	400	2300	0.25	0.1	69
MMSZ5272B	R2	110	104.5	115.5	1.1	750	3000	0.25	0.1	84

- NOTE: 1. "B" Suffix type numbers shown have a standard tolerance of $\pm 5\%$ on the nominal zener voltages.
 2. Nominal zener voltage is measured with the device junction in thermal equilibrium at TL = 30°C ± 1 °C.
 3. ZzT and Zzk are measured by dividing the AC voltage drop across the device by the ac current applied. The specified limits are for Iz(AC) = 0.1 Iz(DC) with the AC frequency = 1 kHz.
 4. Use SZ prefix for AEC-Q101

ELECTRICAL CHARACTERISTICS - 2% TOLERANCE

@ Ta = 25°C unless otherwise specified, Vf = 0.9V max @ If = 10mA

Part Number*	Marking Code	Zener Voltage Range			Test Current	Maximum Zener Impedance			Maximum Reverse Leakage Current	
		Vz @ IzT				IzT	ZzT @ IzT	Zzk @ Izk = 0.25mA	IR	@ VR
		Norm (V)	Min (V)	Max (V)	mA	Ω	Ω	mA	µa	V
MMSZ5226C	TD	3.3	3.234	3.366	20	28	1600	0.25	25	1
MMSZ5231C	TG	5.1	4.998	5.202	20	17	1600	0.25	5	2
MMSZ5232C	TH	5.6	5.488	5.712	20	11	1600	0.25	5	3
MMSZ5245C	TK	15	14.7	15.3	8.5	16	600	0.25	0.1	11
MMSZ5248C	TL	18	17.64	18.36	7	21	600	0.25	0.1	14
MMSZ5250C	TN	20	19.6	20.4	6.2	25	600	0.25	0.1	15
MMSZ5252C	TQ	24	23.52	24.48	5.2	33	600	0.25	0.1	18
MMSZ5256C	TW	30	29.4	30.6	4.2	49	600	0.25	0.1	23

- NOTE: 1. "C" Suffix type numbers shown have a standard tolerance of $\pm 2\%$ on the nominal zener voltages.
 2. Nominal zener voltage is measured with the device junction in thermal equilibrium at TL = 30°C ± 1 °C.
 3. ZzT and Zzk are measured by dividing the AC voltage drop across the device by the ac current applied. The specified limits are for Iz(AC) = 0.1 Iz(DC) with the AC frequency = 1 kHz.
 4. Use SZ prefix for AEC-Q101

TYPICAL CHARACTERISTICS CURVES

Figure 1. Temperature Coefficients

(Temperature Range: -55°C ~ +150°C)

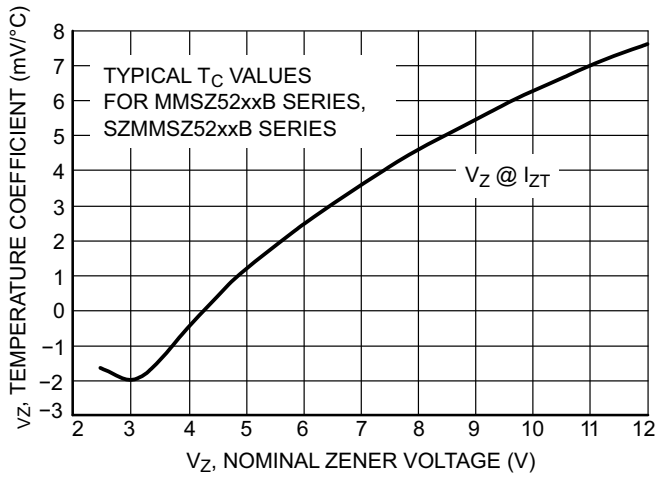

Figure 2. Temperature Coefficients

(Temperature Range: -55°C ~ +150°C)

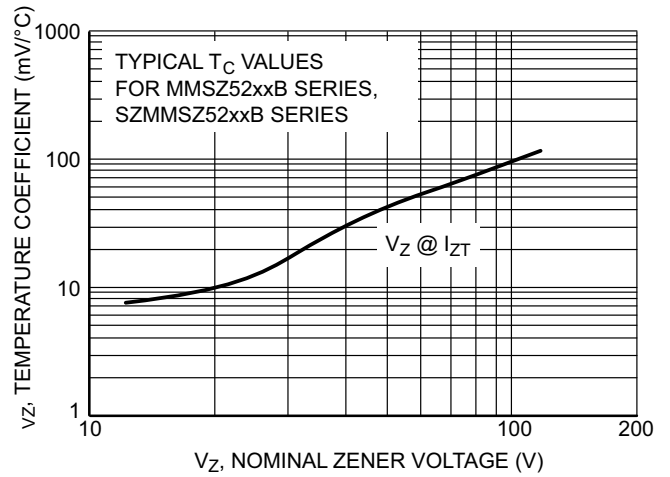

Figure 3. Steady State Power Derating

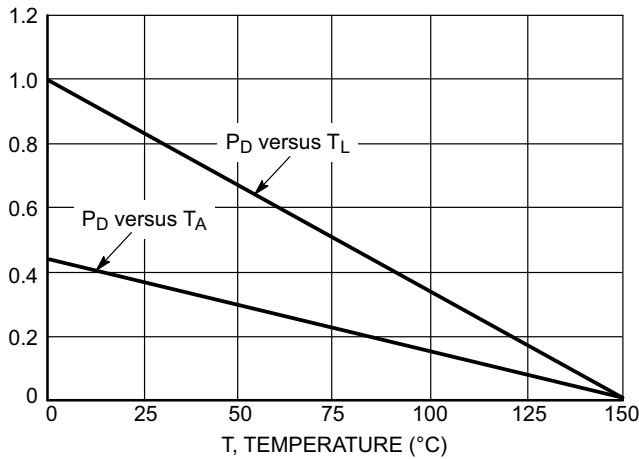

Figure 4. Maximum Nonrepetitive Surge Power

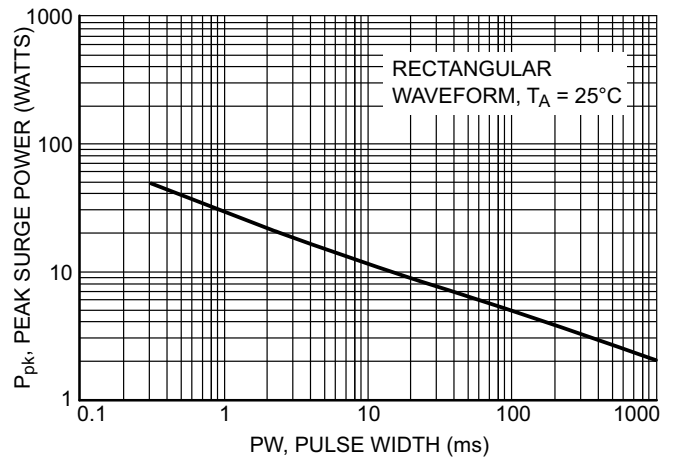

Figure 5. Effect of Zener Voltage on Zener Impedance

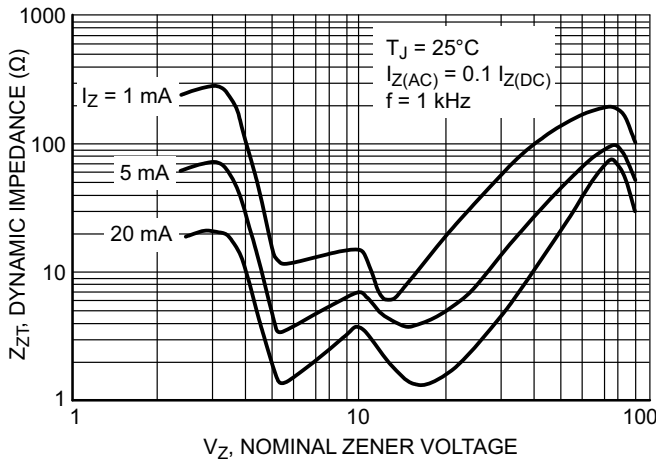
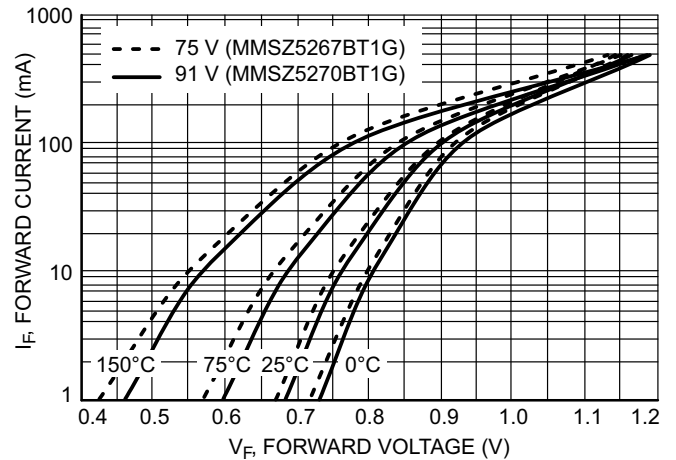

Figure 6. Typical Forward Voltage



■ **TYPICAL CHARACTERISTICS CURVES (Cont'd)**

Figure 7. Typical Capacitance

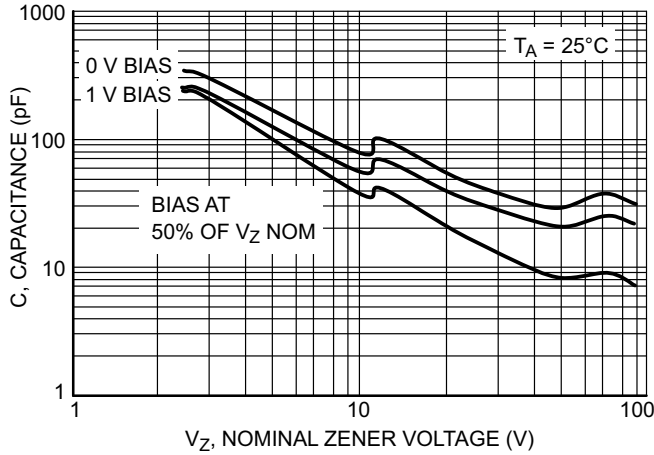

Figure 8. Typical Leakage Current

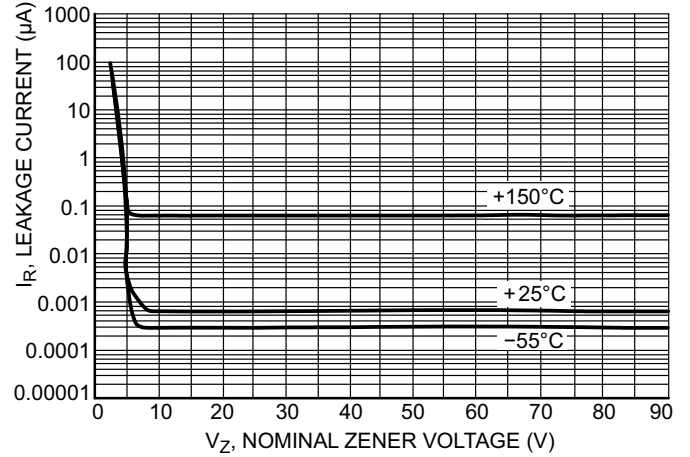

Figure 9. Zener Voltage versus Zener Current (V_Z Up to 12 V)

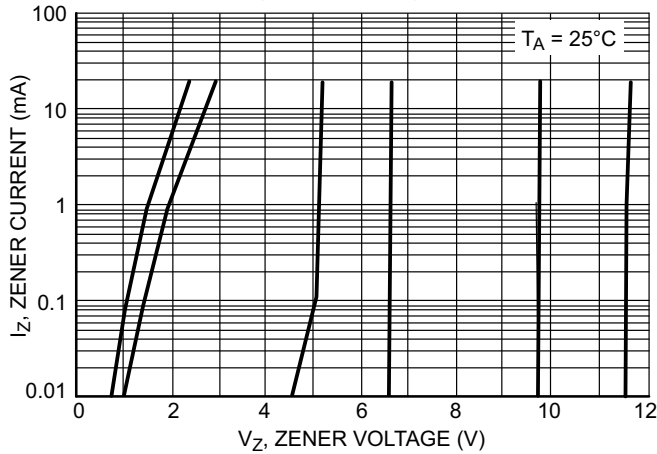

Figure 10. Zener Voltage versus Zener Current (12 V to 91 V)

