

# Bias Resistor Transistor

## PNP Silicon Surface Mount Transistor with Monolithic Bias Resistor Network

This new series of digital transistors is designed to replace a single device and its external resistor bias network. The BRT (Bias Resistor Transistor) contains a single transistor with a monolithic bias network consisting of two resistors; a series base resistor and a base-emitter resistor. The BRT eliminates these individual components by integrating them into a single device. The use of a BRT can reduce both system cost and board space. The device is housed in the SOT-23 package which is designed for low power surface mount applications.

- \* Simplifies Circuit Design
- \* Reduces Board Space
- \* Reduces Component Count
- \* The SOT-23 package can be soldered using wave or reflow. The modified gull-winged leads absorb thermal stress during soldering eliminating the possibility of damage to the die.
- \* Available in 8 mm embossed tape and reel. Use the Device Number to order the 7 inch/3000 unit reel. Replace "T1" with "T3" in the Device Number to order the 13 inch/10,000 unit reel

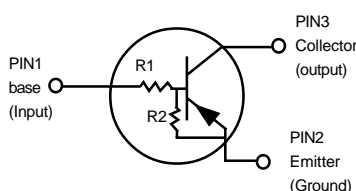

MMUN2111RLT1  
 MMUN2112RLT1  
 MMUN2113RLT1  
 MMUN2114RLT1  
 MMUN2115RLT1  
 MMUN2116RLT1  
 MMUN2130RLT1  
 MMUN2131RLT1  
 MMUN2132RLT1  
 MMUN2133RLT1  
 MMUN2134RLT1

PNP SILICON  
 BIAS RESISTOR  
 TRANSISTOR



CASE 318-08, STYLE 6  
 SOT- 23 (TO-236AB)

### MAXIMUM RATINGS (T<sub>A</sub> = 25°C unless otherwise noted)

Rating	Symbol	Value	Unit
Collector-Base Voltage	V <sub>CB0</sub>	50	Vdc
Collector-Emitter Voltage	V <sub>CEO</sub>	50	Vdc
Collector Current	I <sub>C</sub>	100	mAdc
Total Power Dissipation @ T <sub>A</sub> = 25°C <sup>(1)</sup>	P <sub>D</sub>	200	mW
Derate above 25°C		1.6	mW/°C

### THERMAL CHARACTERISTICS

Rating	Symbol	Value	Unit
Thermal Resistance — Junction-to-Ambient (surface mounted)	R <sub>θJA</sub>	625	°C/W
Operating and Storage Temperature Range	T <sub>J</sub> , T <sub>stg</sub>	-65 to +150	°C
Maximum Temperature for Soldering Purposes	T <sub>L</sub>	260	°C
Time in Solder Bath		10	Sec

### DEVICE MARKING AND RESISTOR VALUES

Device	Marking	R1 (K)	R2 (K)
MMUN2111LT1	A6A	10	10
MMUN2112LT1	A6B	22	22
MMUN2113LT1	A6C	47	47
MMUN2114LT1	A6D	10	47
MMUN2115LT1 <sup>(2)</sup>	A6E	10	∞

1. Device mounted on a FR-4 glass epoxy printed circuit board using the minimum recommended footprint.
2. New devices. Updated curves to follow in subsequent data sheets.

**MMUN2111RLT1 SERIES**

**DEVICE MARKING AND RESISTOR VALUES** (Continued)

Device	Marking	R1 (K)	R2 (K)
MMUN2116RLT1 <sup>(2)</sup>	A6F	4.7	∞
MMUN2130RLT1 <sup>(2)</sup>	A6G	1.0	1.0
MMUN2131RLT1 <sup>(2)</sup>	A6H	2.2	2.2
MMUN2132RLT1 <sup>(2)</sup>	A6J	4.7	4.7
MMUN2133RLT1 <sup>(2)</sup>	A6K	4.7	47
MMUN2134RLT1 <sup>(2)</sup>	A6L	22	47

**ELECTRICAL CHARACTERISTICS** (T<sub>A</sub> = 25°C unless otherwise noted)

Characteristic	Symbol	Min	Typ	Max	Unit
----------------	--------	-----	-----	-----	------

**OFF CHARACTERISTICS**

Collector-Base Cutoff Current (V <sub>CB</sub> =50V, I <sub>E</sub> = 0)	I <sub>CBO</sub>	-	-	100	nAdc	
Collector-Emitter Cutoff Current (V <sub>CE</sub> = 50 V, I <sub>B</sub> = 0)	I <sub>CEO</sub>	-	-	500	nAdc	
Emitter-Base Cutoff Current (V <sub>EB</sub> = 6.0 V, I <sub>C</sub> = 0)	MMUN2111RLT1	I <sub>EBO</sub>	-	-	0.5	mAdc
	MMUN2112RLT1		-	-	0.2	
	MMUN2113RLT1		-	-	0.1	
	MMUN2114RLT1		-	-	0.2	
	MMUN2115RLT1		-	-	0.9	
	MMUN2116RLT1		-	-	1.9	
	MMUN2130RLT1		-	-	4.3	
	MMUN2131RLT1		-	-	2.3	
	MMUN2132RLT1		-	-	1.5	
	MMUN2133RLT1		-	-	0.18	
MMUN2134RLT1		-	-	0.13		
Collector-Base Breakdown Voltage (I <sub>C</sub> = 10 μA, I <sub>E</sub> = 0)	V <sub>(BR)CBO</sub>	50	-	-	Vdc	
Collector-Emitter Breakdown Voltage <sup>(3)</sup> (I <sub>C</sub> =2.0mA, I <sub>B</sub> =0)	V <sub>(BR)CEO</sub>	50	-	-	Vdc	

**ON CHARACTERISTICS** <sup>(3)</sup>

DC Current Gain (V <sub>CE</sub> = 10 V, I <sub>C</sub> = 5.0 mA)	MMUN2111RLT1	h <sub>FE</sub>	35	60	-
	MMUN2112RLT1		60	100	-
	MMUN2113RLT1		80	140	-
	MMUN2114RLT1		80	140	-
	MMUN2115RLT1		160	250	-
	MMUN2116RLT1		160	250	-
	MMUN2130RLT1		3.0	5.0	-
	MMUN2131RLT1		8.0	15	-
	MMUN2132RLT1		15	27	-
	MMUN2133RLT1		80	140	-
MMUN2134RLT1		80	130	-	
Collector-Emitter Saturation Voltage (I <sub>C</sub> =10mA, I <sub>E</sub> =0.3mA)	V <sub>CE(sat)</sub>	-	-	0.25	Vdc
(I <sub>C</sub> = 10 mA, I <sub>B</sub> = 5 mA)	MMUN2130RLT1	MMUN2131RLT1			
(I <sub>C</sub> = 10 mA, I <sub>B</sub> = 1 mA)	MMUN2115RLT1	MMUN2116RLT1			
	MMUN2132RLT1	MMUN2133RLT1	MMUN2134RLT1		
Output Voltage (on) (V <sub>CC</sub> =5.0V, V <sub>B</sub> =2.5V, R <sub>L</sub> =1.0kΩ)	MMUN2111RLT1	V <sub>OL</sub>	-	-	0.2
	MMUN2112RLT1		-	-	0.2
	MMUN2114RLT1		-	-	0.2
	MMUN2115RLT1		-	-	0.2
	MMUN2116RLT1		-	-	0.2
	MMUN2130RLT1		-	-	0.2
	MMUN2131RLT1		-	-	0.2
	MMUN2132RLT1		-	-	0.2
	MMUN2133RLT1		-	-	0.2
	MMUN2134RLT1		-	-	0.2
(V <sub>CC</sub> =5.0V, V <sub>B</sub> =3.5V, R <sub>L</sub> = 1.0kΩ)	MMUN2113RLT1		-	-	0.2

2. New devices. Updated curves to follow in subsequent data sheets.

3. Pulse Test: Pulse Width < 300 ms, Duty Cycle < 2.0%

2-446 LRC Small-Signal Transistors, FETs and Diodes Device Data

### MMUN2111RLT1 SERIES

**ELECTRICAL CHARACTERISTICS** ( $T_A = 25^\circ\text{C}$  unless otherwise noted) (Continued)

Characteristic	Symbol	Min	Typ	Max	Unit
Output Voltage (off) ( $V_{CC} = 5.0\text{V}$ , $V_B = 0.5\text{V}$ , $R_L = 1.0\text{k}\Omega$ ) ( $V_{CC} = 5.0\text{V}$ , $V_B = 0.25\text{V}$ , $R_L = 1.0\text{k}\Omega$ )	$V_{OH}$	4.9	—	—	Vdc
MMUN2115RLT1					
MMUN2116RLT1					
MMUN2131RLT1					
MMUN2132RLT1					
( $V_{CC} = 5.0\text{V}$ , $V_B = 0.050\text{V}$ , $R_L = 1.0\text{k}\Omega$ )	MMUN2130RLT1				
Input Resistor	MMUN2111RLT1	$R_1$	7.0	10	13
	MMUN2112RLT1		15.4	22	28.6
	MMUN2113RLT1		32.9	47	61.1
	MMUN2114RLT1		7.0	10	13
	MMUN2115RLT1		7.0	10	13
	MMUN2116RLT1		3.3	4.7	6.1
	MMUN2130RLT1		0.7	1.0	1.3
	MMUN2131RLT1		1.5	2.2	2.9
	MMUN2132RLT1		3.3	4.7	6.1
	MMUN2133RLT1		3.3	4.7	6.1
	MMUN2134RLT1		15.4	22	28.6
Resistor Ratio	MMUN2111RLT1 MMUN2112RLT1 MMUN2113RLT1	$R_1/R_2$	0.8	1.0	1.2
	MMUN2114RLT1		0.17	0.21	0.25
	MMUN2115RLT1 MMUN2116RLT1		—	—	—
	MMUN2130RLT1 MMUN2131RLT1 MMUN2132RLT1		0.8	1.0	1.2
	MMUN2133RLT1		0.055	0.1	0.185

MMUN2111RLT1 SERIES

TYPICAL ELECTRICAL CHARACTERISTICS  
MMUN2111RLT1

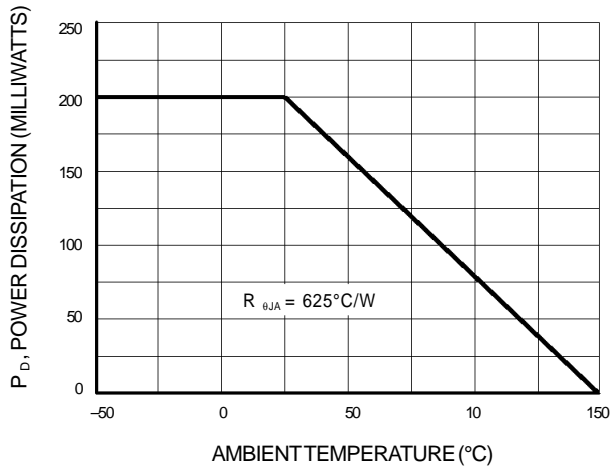

Figure 1. Derating Curve

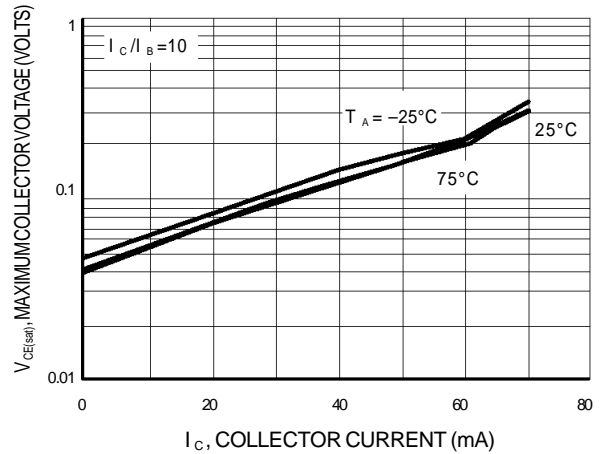

Figure 2.  $V_{CE(sat)}$  versus  $I_C$

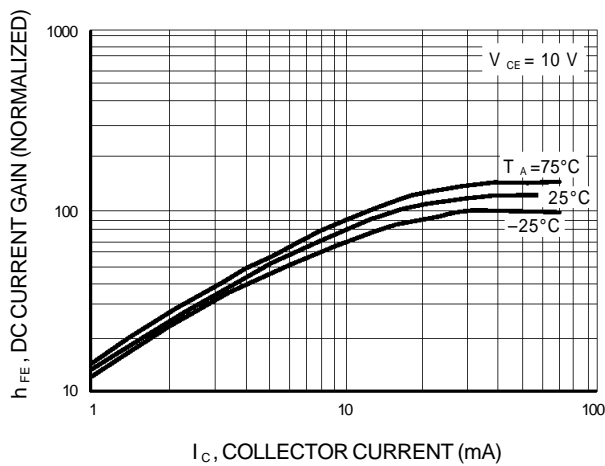

Figure 3. DC Current Gain

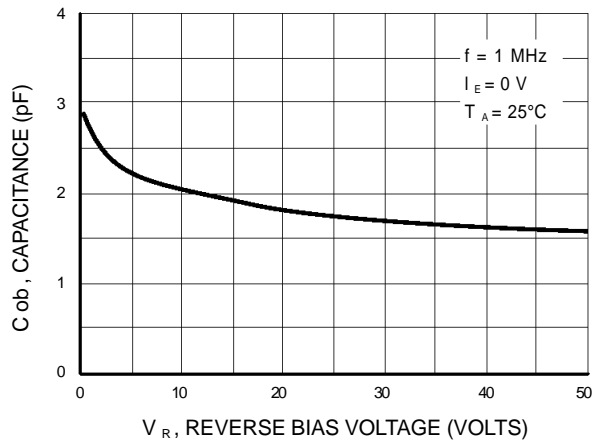

Figure 4. Output Capacitance

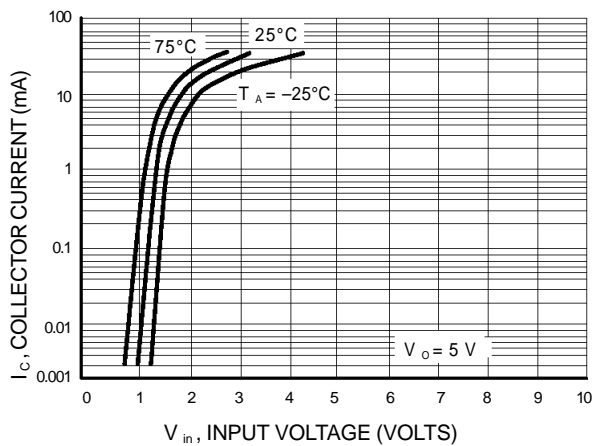

Figure 5. Output Current versus Input Voltage

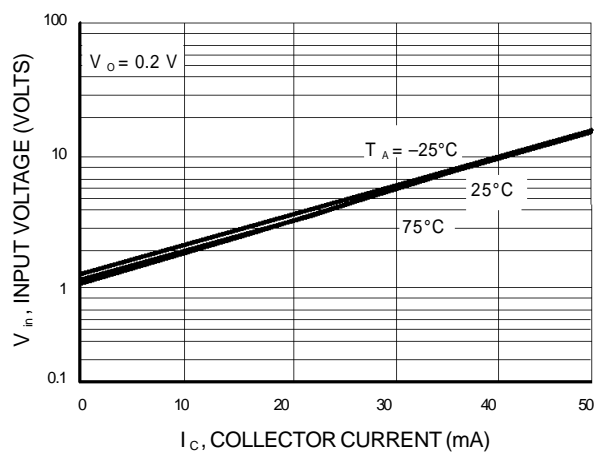

Figure 6. Input Voltage versus Output Current

MMUN2111RLT1 SERIES

TYPICAL ELECTRICAL CHARACTERISTICS  
MMUN2112RLT1

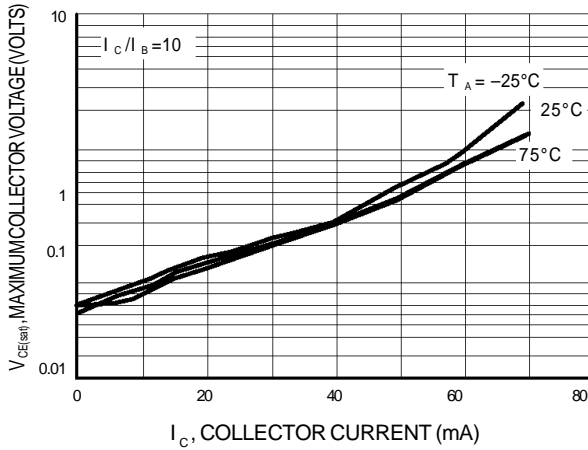

Figure 7.  $V_{CE(sat)}$  versus  $I_C$

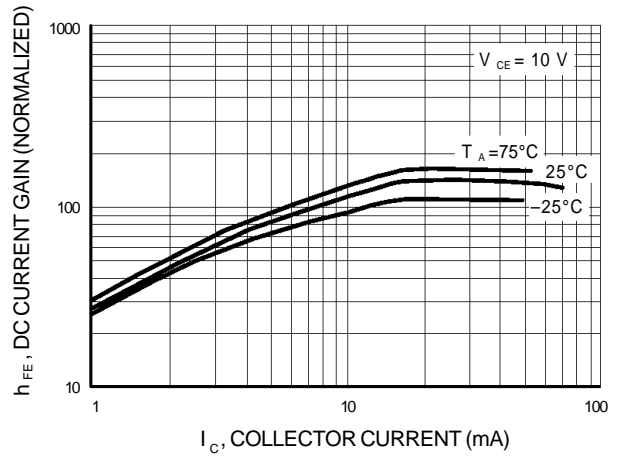

Figure 8. DC Current Gain

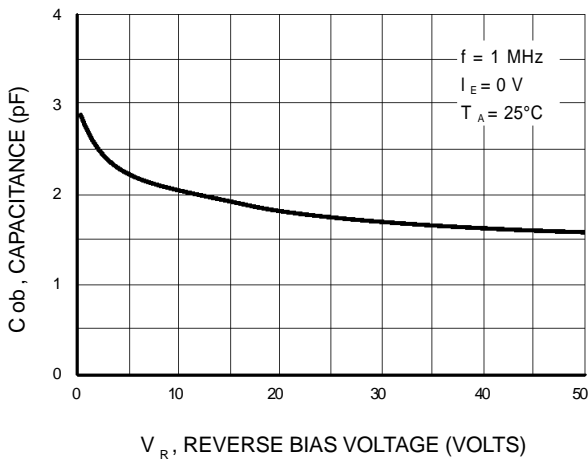

Figure 9. Output Capacitance

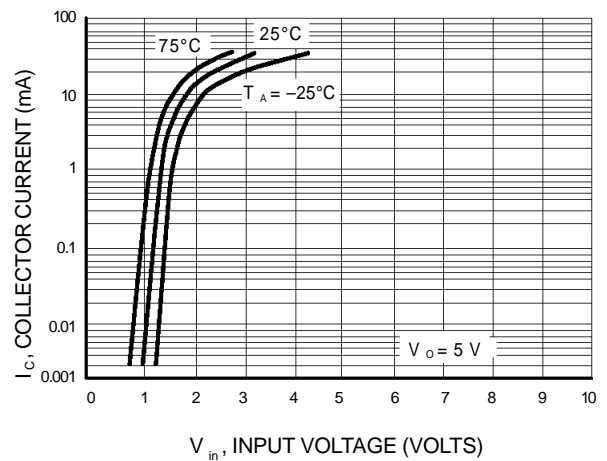

Figure 10. Output Current versus Input Voltage

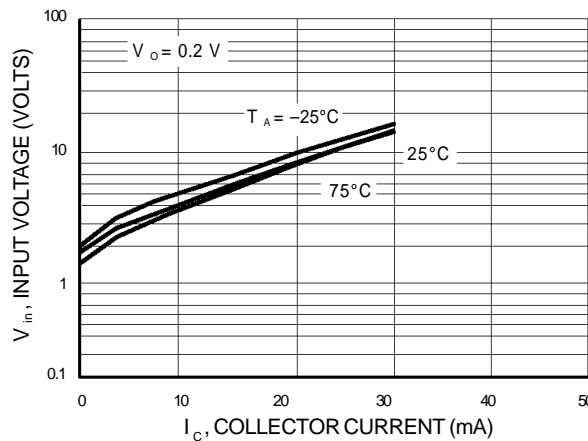

Figure 11. Input Voltage versus Output Current

MMUN2111RLT1 SERIES

TYPICAL ELECTRICAL CHARACTERISTICS  
MMUN2113RLT1

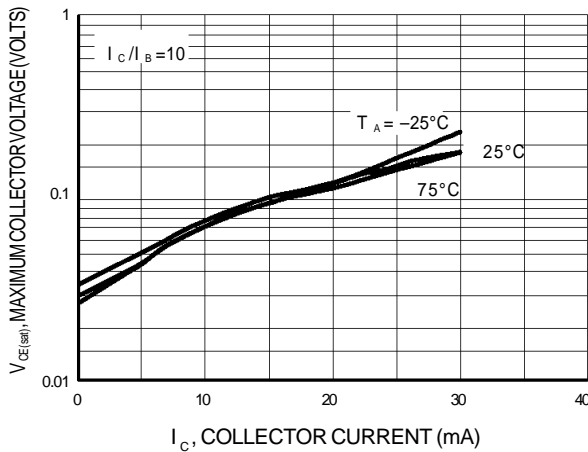

Figure 12.  $V_{CE(sat)}$  versus  $I_C$

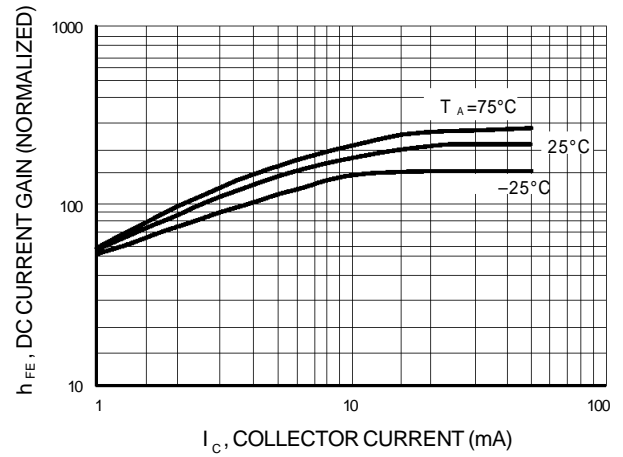

Figure 13. DC Current Gain

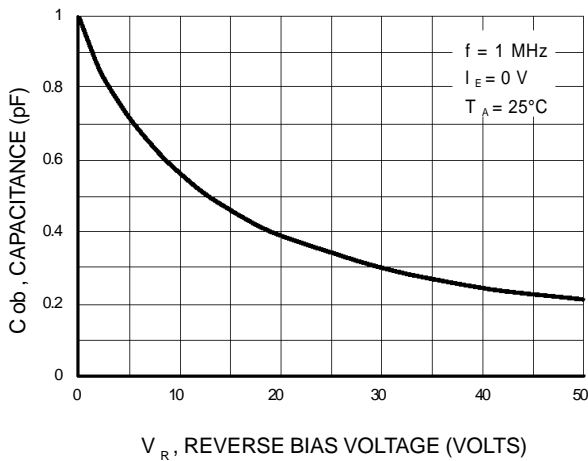

Figure 14. Output Capacitance

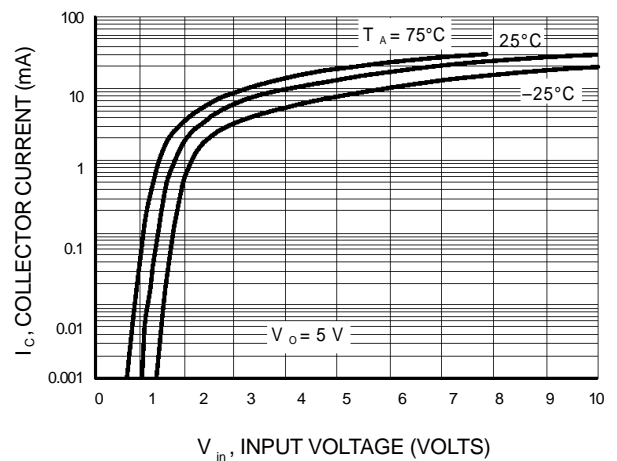

Figure 15. Output Current versus Input Voltage

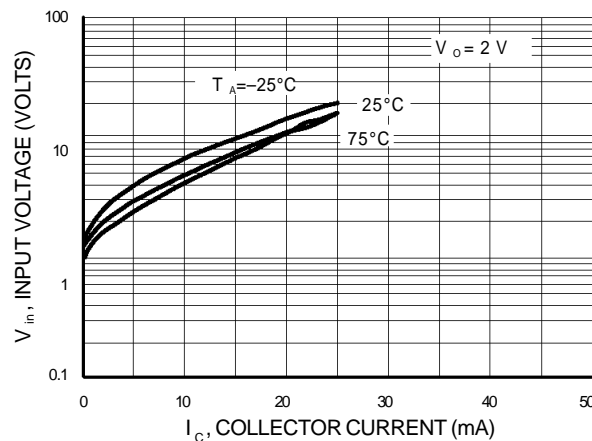

Figure 16. Input Voltage versus Output Current

MMUN2111RLT1 SERIES

TYPICAL ELECTRICAL CHARACTERISTICS  
MMUN2114RLT1

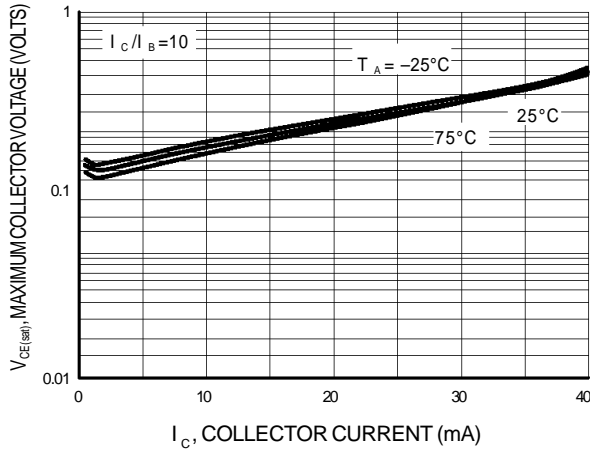

Figure 17.  $V_{CE(sat)}$  versus  $I_C$

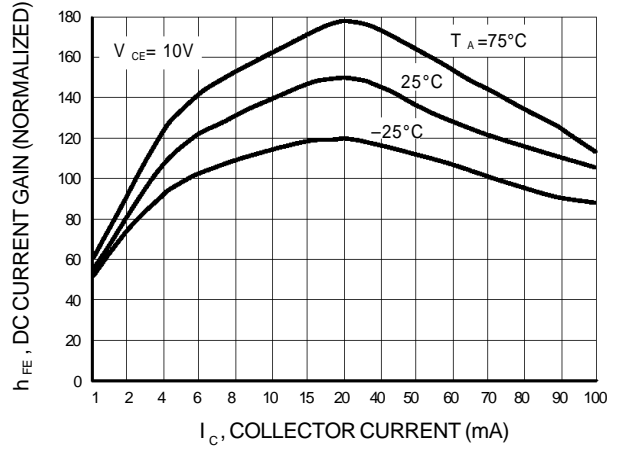

Figure 18. DC Current Gain

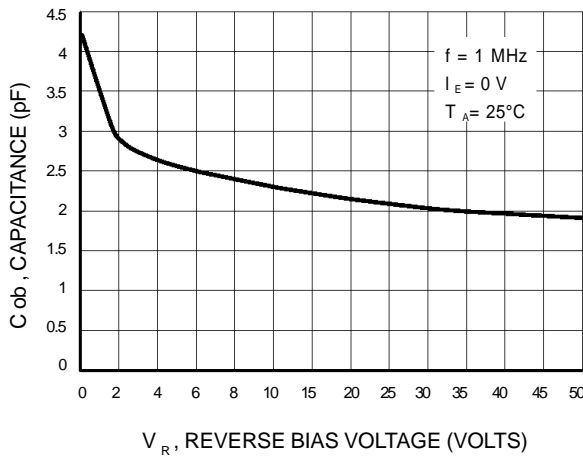

Figure 19. Output Capacitance

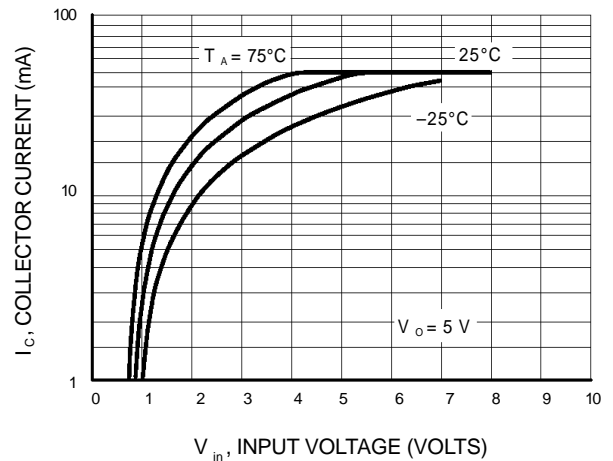

Figure 20. Output Current versus Input Voltage

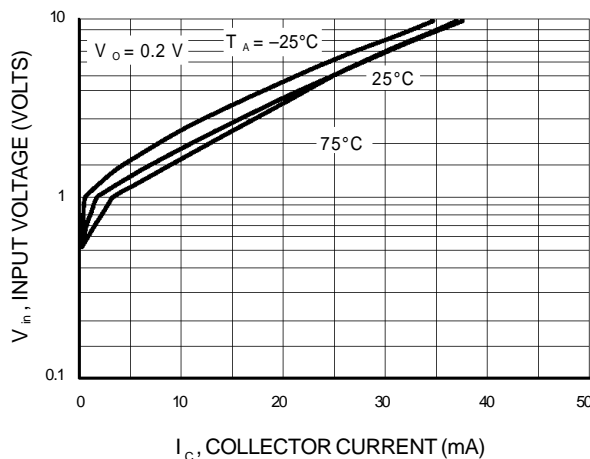

Figure 21. Input Voltage versus Output Current

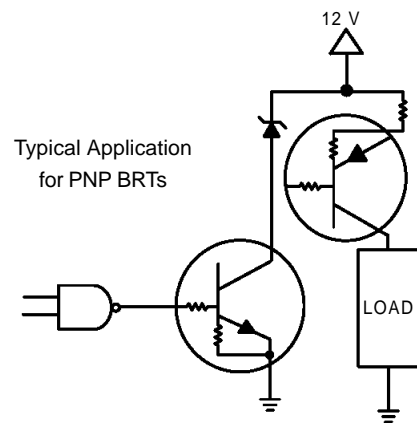

Figure 22. Inexpensive, Unregulated Current Source